

Hybrid IC Base Drive Module 2 Amperes/10 Volts

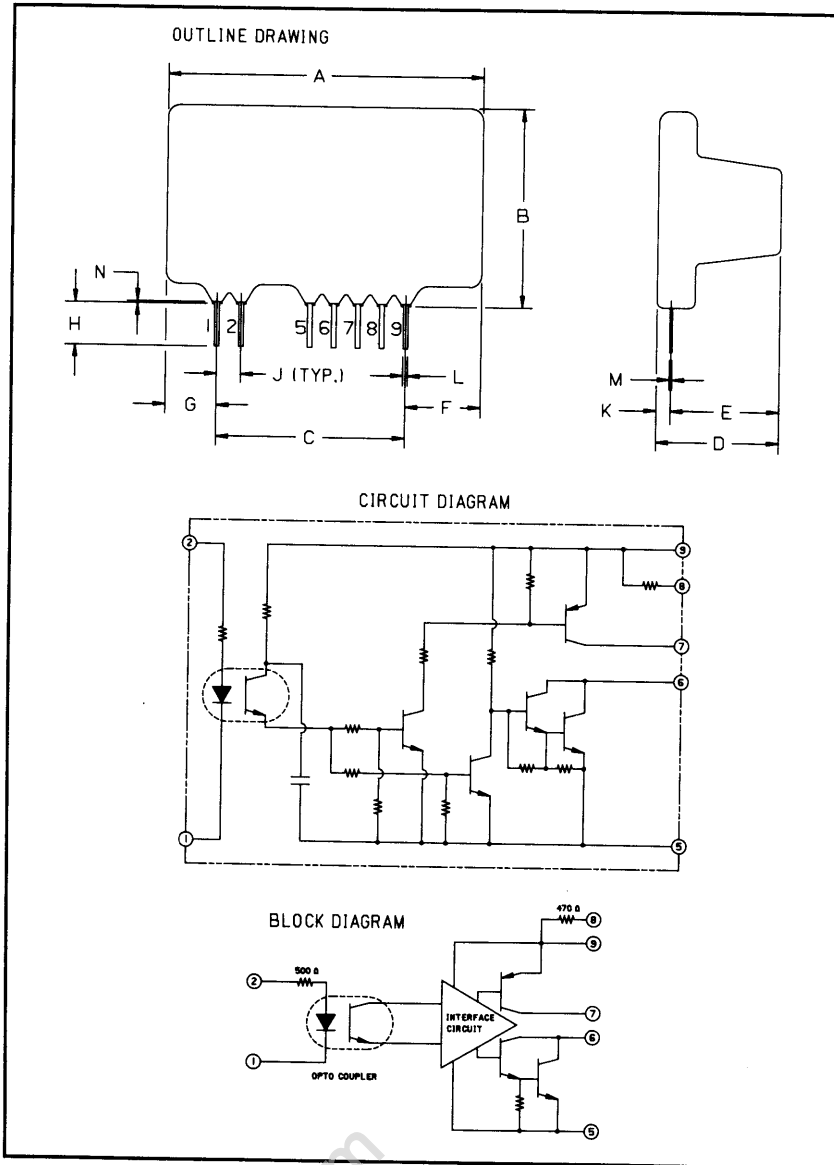

Outline Drawing

Dimensions	Inches	Millimeters
A	1.319 Max.	33.5 Max.
B	0.827	21
C	0.800 ± 0.012	20.32 ± 0.3
D	0.472 Max.	12 Max.
E	0.053 Max.	11.5 Max.
F	0.315 Max.	8 Max.
G	0.216 Max.	5.5 Max.

Dimensions	Inches	Millimeters
H	0.177 ± 0.059	4.5 ± 1.5
J	0.100 ± 0.004	2.54 ± 0.1
K	0.071 Max.	1.8 Max.
L	0.022 ± 0.004	0.55 ± 0.1
M	0.014 ± 0.008	0.35 ± 0.2
N	0.008 Min.	0.2 Min.

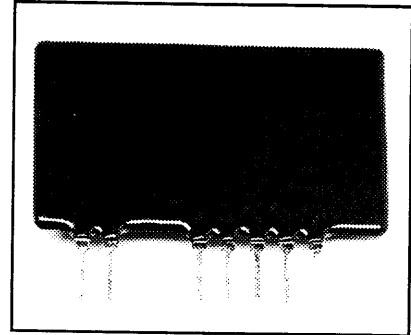

Description:

The Powerex Hybrid IC's are designed to provide logic compatible drive for transistor modules. The module includes an integral optoisolator for electrical isolation between input and output.

Features:

- Small, Lightweight
- Low Power Consumption
- TTL Logic Compatible
- Input/Output Electrically Isolated
- Single In-line Package
- Single Power Supply Drive
- Reverse Base Current Pulse Capability

Applications:

- Transistor Base Drive
- Inverter Circuits

Ordering Information:

Example: Select the complete seven digit part number you desire from the table - i.e. M57903L is a 2500 Volt dielectric drive module suitable for driving 1000 Volt transistor modules rated at 15 to 75 Amperes.

Type	Package	Optoisolator
M57903L	7-pin SIL	Yes



Powerex, Inc., 200 Hillis Street, Youngwood, Pennsylvania 15697-1800 (412) 925-7272

M57903L
Hybrid IC Base Drive Module
 2 Amperes/10 Volts

Absolute Maximum Ratings, $T_A = -20\text{ }^\circ\text{C}$ to $70\text{ }^\circ\text{C}$ unless otherwise specified

Ratings	Symbol	M57903L	Units
Operating Temperature Substrate	T_{stg}	-25 to 100	$^\circ\text{C}$
Operating Temperature Ambient	T_S	-20 to 70	$^\circ\text{C}$
Supply Voltage	V_{CC}	14	Volts
Input Voltage	V_I	-1 to 7	Volts
"H" Output Current	I_{OH}	1	Amperes
"L" Output Peak Current*	I_{OLP}	-3	Amperes
V Isolation	V_{RMS}	2500	Volts

* Pulse Width 10 μs , $f = 2\text{KHZ}$

Electrical and Mechanical Characteristics, $T_A = 25\text{ }^\circ\text{C}$, $V_{CC} = 10\text{V}$ unless otherwise specified

Characteristics	Symbol	Test Conditions	Min.	Typ.	Max.	Units
"H" Input Current	I_{IH}	$V_I = 5\text{V}$	-	7	-	mA
"H" Output Current	I_{OH}	$R_{EXT} = 6.4\Omega$, $C_{EXT} = 47\mu\text{f}$	-	0.9	-	Amperes
"L" Output Peak Current	I_{OLP}	$R_{EXT} = 6.4\Omega$, $C_{EXT} = 47\mu\text{f}$	-	-2	-	Amperes
"L" - "H" Propagation Delay	t_{PLH}	$T_S = 100^\circ\text{C}$, $V_{IN} = 0$ to 4V	-	5	10	μs
"L" - "H" Rise Time	t_r	$T_S = 100^\circ\text{C}$, $V_{IN} = 0$ to 4V	-	-	1	μs
"H" - "L" Propagation Delay	t_{PHL}	$T_S = 100^\circ\text{C}$, $V_{IN} = 5$ to 0V	-	8	15	μs
"H" - "L" Fall Time	t_f	$T_S = 100^\circ\text{C}$, $V_{IN} = 5$ to 0V	-	-	1	μs
Internal Power Dissipation	P_D	$I_{OH} = 0.9\text{A}$, $I_{OLP} = -2\text{A}$, $f = 2\text{kHz}$, Duty = 50%	-	0.8	-	Watts

Recommended Operating Conditions (Refer to Typical Application Circuit)

Symbol	KD7245A1, KD724502			KD224503			KD224505			Units
	Min.	Typ.	Max.	Min.	Typ.	Max.	Min.	Typ.	Max.	
V_{CC}	9	10	11	9	10	11	9	10	11	Volts
V_{IH}	4	-	5	4	-	5	4	-	5	Volts
R_{ext}	-	20	-	-	15	-	-	8.7	-	Ω
C_{ext}	-	22	-	-	33	-	-	47	-	μf
C_1	-	2200	-	-	3300	-	-	4700	-	μf
f	-	2	-	-	2	-	-	2	-	kHz

NOTE: When using transistor modules at 100A and above (i.e. KD324510, KD324515, KD324520, etc.) Also use Drive Module KS021K01.



Powerex, Inc., 200 Hillis Street, Youngwood, Pennsylvania 15697-1800 (412) 925-7272

M57903L
Hybrid IC Base Drive Module
2 Amperes/10 Volts

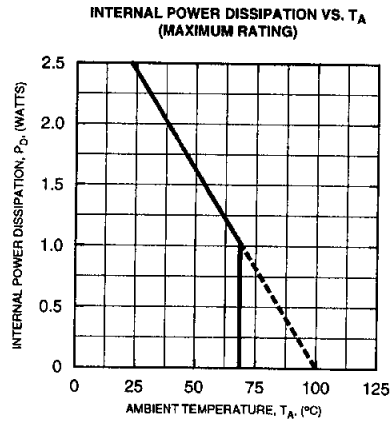
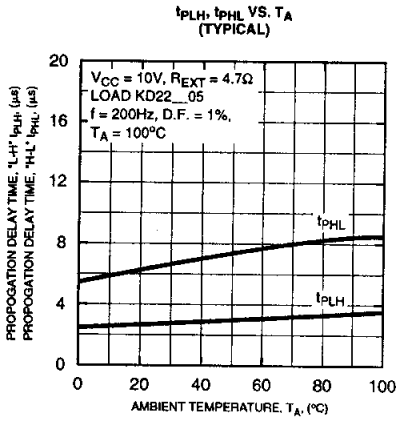
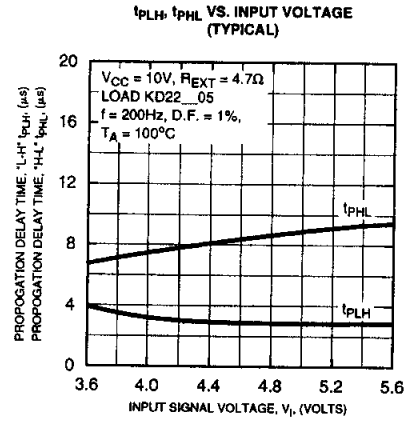
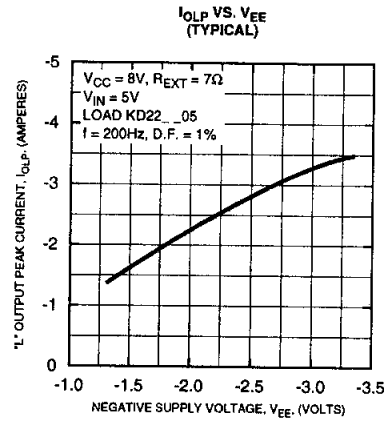
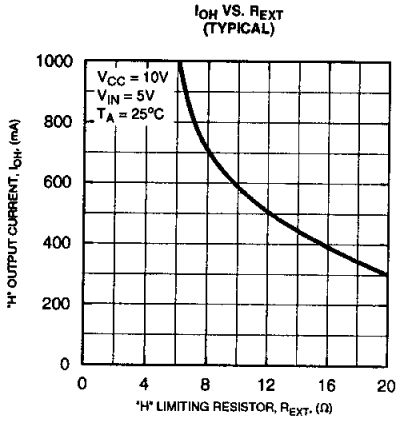

M57903L
Hybrid IC Base Drive Module
 2 Amperes/10 Volts

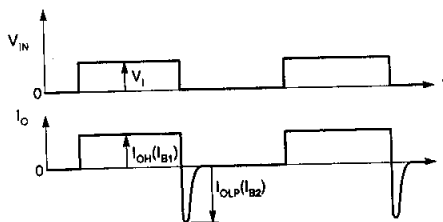
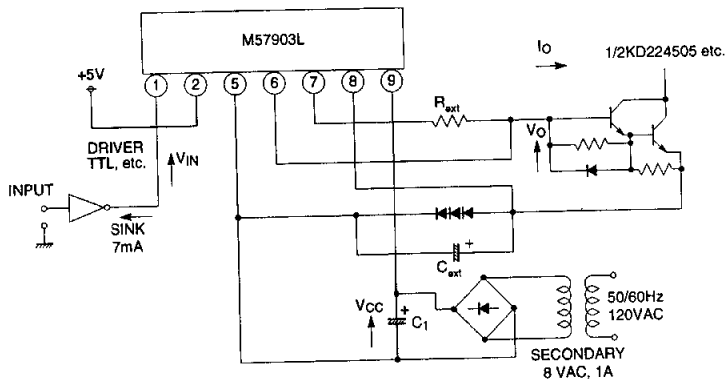

NOTE: I_{OH} AND I_{OLP} CORRESPOND TO BASE FORWARD CURRENT I_{B1} AND BASE REVERSE CURRENT I_{B2} OF THE TRANSISTOR MODULE TO BE DRIVEN RESPECTIVELY.