

M58412P, M58413P

CMOS LCD DIGITAL ALARM CLOCK CIRCUITS

DESCRIPTION

The M58412P and M58413P CMOS aluminum-gated LSIs serve 4-digit liquid-crystal display (LCD) digital alarm clocks employing quartz oscillators of 4.2 MHz and 32 kHz respectively.

FEATURES

- Low current consumption. Under ordinary conditions, M58412P consumes 30 μ A at an oscillator frequency of 4.2 MHz and $V_{SS(1)}$ level of -1.5V, while M58413P consumes 2 μ A at 32 kHz and $V_{SS(1)}$ of -1.5V.
- The 12-hour clock-display function shows AM or PM hours and minutes; the 24-hour system shows hours and minutes alone.
- Separate switches enable independent setting of hours and minutes.
- Five alarm output signals are provided: a continuous alarm-bell signal, intermittent alarm-bell signal, external bell-oscillator-circuit-drive signal, external electronic-apparatus switching signal, and 12 min or 120 min DC signal.
- The alarm bell output can continue for up to 12 min.
- A 10 min 'snooze' function is incorporated.
- The LSI causes the whole display to flash on and off when battery voltage drops below the specified level.
- Two LCD mark outputs are provided: alarm and sleep. The display offers immediate indication of the function in current operation.
- The LSIs enable sleep and auto-recording timers to be set at any time during a 59-minute period. A 120-minute output mode is also available with auto-recording timers.

PIN CONFIGURATION (TOP VIEW)

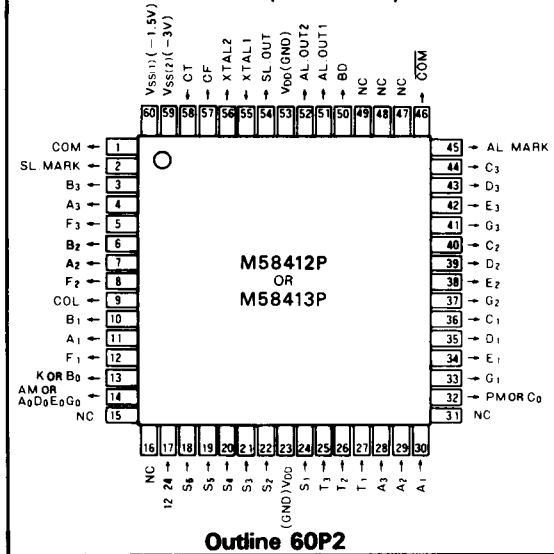

APPLICATIONS

- Alarm clocks with a 'snooze' function
- Sleep timers
- Travel watches
- Switching timers for electronic apparatus
- Auto-recording timers for audio equipment

FUNCTIONS

Normal clock, alarm clock, 'snooze' timer, sleep timer, electronic-apparatus switching timer, and audio-equipment auto-recording timer functions are provided by the oscillator and frequency divider (4.2 MHz for M58412P and 32 kHz for M58413P).

BLOCK DIAGRAM

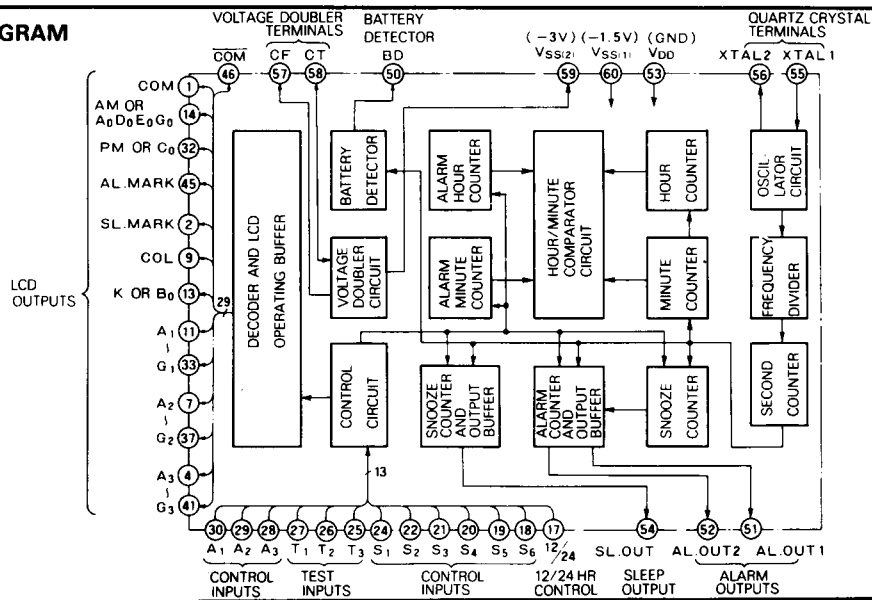

M58412P, M58413P

CMOS LCD DIGITAL ALARM CLOCK CIRCUITS

OPERATION

The following figures and tables show the LCD-electrode

arrays on the LCD panel, the segment codes, and the display modes.

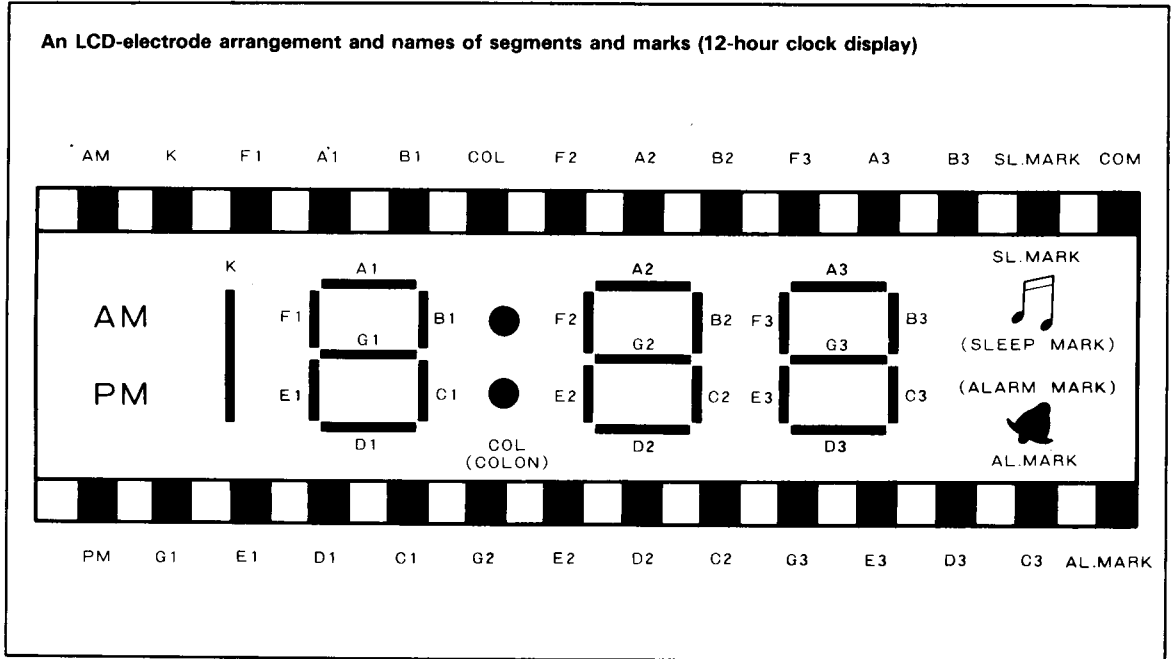

Table 1 12-Hour Clock Display

Mode	Display	Meaning of mark display
Normal clock ordinary display		→ Sleep timer is in operation → Alarm timer is being set.
Alarm		→ Alarm time is displayed, adjustment possible.
Sleep-time		→ Sleep time is displayed, adjustment possible. → Alarm timer is being set.

Note 1. The symbol indicates a 2sec on-off flash.

CMOS LCD DIGITAL ALARM CLOCK CIRCUITS

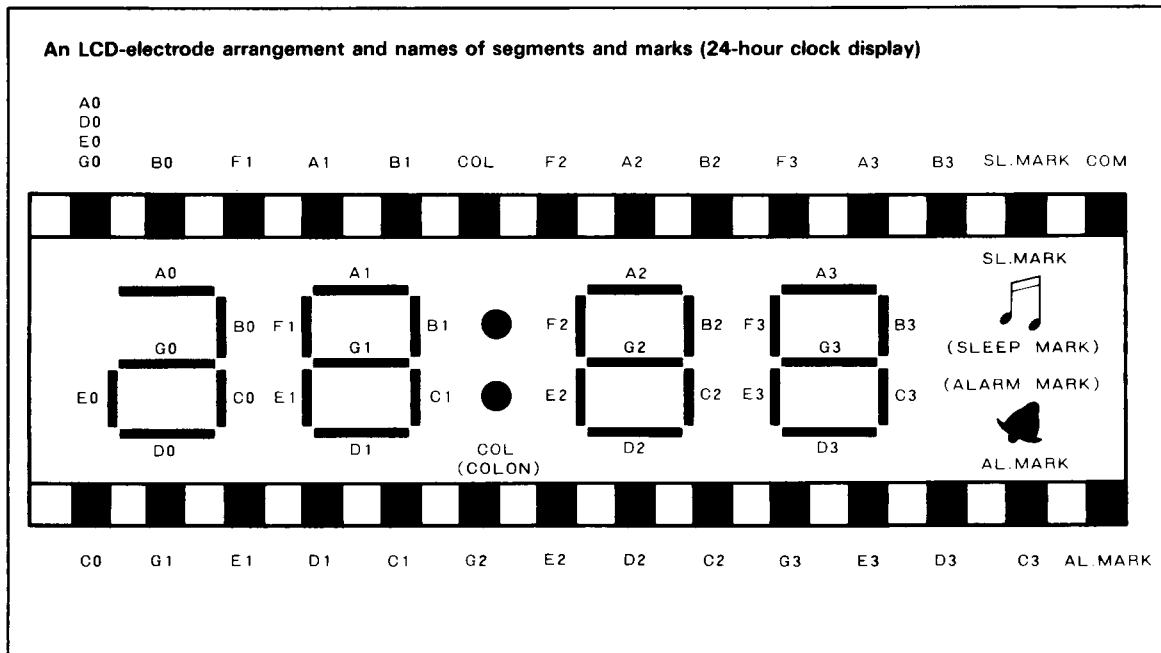

Table 2 24-Hour Clock Display

Mode	Display	Meaning of mark display
Normal display	20:56	<ul style="list-style-type: none"> Sleep timer is in operation Alarm timer is being set
Alarm display	7:00	<ul style="list-style-type: none"> Alarm time is displayed; adjustment possible
Sleep-time display	30	<ul style="list-style-type: none"> Sleep time is displayed; adjustment possible Alarm timer is being set

Note 2: The symbol indicates a 2sec on-off flash.

10

CMOS LCD DIGITAL ALARM CLOCK CIRCUITS**FUNCTIONS OF INPUT AND OUTPUT PINS****Input Pins**

The potential drop to the level of $V_{SS(1)}$ ($-1.5V$) or $V_{SS(2)}$ ($-3V$) achieved inside the LSI ensures that all the input pins are used in the floating-state condition. The input pins A_1 , A_2 , A_3 , S_1 , and S_6 have the potential of $V_{SS(1)}$, while all the other input pins have $V_{SS(2)}$. Signal input requires the use of the $V_{DD(GND)}$ level for all input pins.

S₁ Pin

Every push of the S_1 push-button switch advances 1 minute in normal clock-time adjustment, alarm-time setting and sleep-time setting. Raising to the hour digit is prohibited in this operation. In the normal-clock ordinary-display mode, the S_1 pin also serves as a start/stop input pin for the sleep timer. A sleep mark flashing on and off displays the sleep timer's operation. It will disappear when the sleep timer stops operation, or as soon as the time initially set on the sleep timer is reached.

S₂ Pin

Every push of the S_2 push-button switch advances 1 hour in normal clock-time adjustment and alarm-time setting. In the normal-clock ordinary-display mode, the S_2 pin also serves as an input pin to bring the sleep output to the $V_{SS(1)}$ level. This function makes it possible to switch off a radio or other electronic apparatus before the time initially set on the sleep timer is reached.

S₃ Pin

When the A_3 pin is held at the V_{DD} level, a momentary switch should be used to enable the input with the S_3 -pin potential to change momentarily to the V_{DD} level. Pushing the S_3 switch changes the mode cyclically in the sequence: normal-clock ordinary display; alarm-time display (alarm-time setting is possible); and sleep-time display (sleep-time setting is possible). However, when the A_3 pin is in the floating state (the inside-LSI potential is $-1.5V$), it is recommended to use a lock switch to retain the V_{DD} level at the S_3 pin. While S_3 -pin potential is kept at V_{DD} , the alarm-time display mode is effective (alarm-time setting is possible). Disconnecting the S_3 pin restores the normal-clock ordinary-display mode. The sleep-timer mode cannot be used when the A_3 pin is in the floating state. In this case, however, there are convenient applications (for travel watches, etc.) free from the problem of alarm-time lags behind the set time which sometimes arise from the use of momentary switches due to their accidental operation.

S₄ Pin

When the normal-clock normal-display mode of the basic clock is effective, maintaining this pin at the V_{DD} level causes entry to the normal-clock time-adjustment mode. After time adjustment with the S_1 and S_2 pins, clock operation starts with the '00' second of the adjusted time as soon as S_4 is disconnected from the V_{DD} level.

S₅ Pin

This pin is used to provide alarm-timer set input. Maintaining this input pin at the V_{DD} level causes the alarm mark to stay on. When the normal clock time coincides with the alarm time, two types of alarm output, AL. OUT1 and AL. OUT2, generate alarm signals. (The alarm signal with a pulse width of 250ms is generated only once after the coincidence takes place.) When cancellation of the alarm signal is desired, disconnecting the S_5 pin from the V_{DD} level causes both the alarm mark and alarm signal to disappear. No alarm signals will be generated when the normal clock time coincides with the alarm time, unless the S_5 pin is at the V_{DD} level.

S₆ Pin

This pin has three functions: 'snooze' timer-setting input, sleep-timer resetting input, and LCD lamp switching at night. When an alarm signal is generated in the normal-clock ordinary-display mode, bringing the S_6 potential momentarily to V_{DD} stops the alarm signal for a moment and generates it again after 9~10 minutes. (The 1-pulse alarm signal with a 250ms pulse width cannot be generated again.) The 'snooze' function can be repeated at every signal input made to the S_6 pin. However, it does not operate after an alarm signal has continued for 12 minutes. This function is useful for 'snooze' clocks and other applications.

When no alarm signals are generated in the normal-clock ordinary-display mode, or when the 'snooze' function is not in operation, bringing the S_6 potential momentarily to V_{DD} makes it possible to reset the sleep time to 59 minutes and to make the sleep output level V_{DD} . This means that when a stereo or other apparatus connected is to be switched off after 59~60 minutes, it is unnecessary to use the 59 minute setting in the sleep-time display mode: It is only necessary to push the S_6 push-button switch and then push the S_1 -pin start button, giving great ease of operation. The S_6 pin, at a potential level of $-1.5V$, also serves as an LCD lamp power terminal at night (See Fig. 1). Care should be taken, however, over the fact that every time the LCD lamp is turned on a 'snooze' timer set input or sleep-timer/reset input is entered.

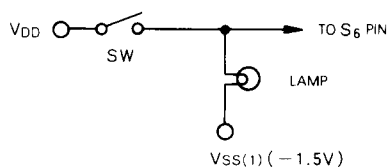
Fig. 1 An LCD lamp circuit

CMOS LCD DIGITAL ALARM CLOCK CIRCUITS

A₁ and A₂ Pins

AL. OUT1 pin alarm output in different modes is generated in accord with a combination of the A₁- and A₂-pin potentials. Table 3 shows four modes and their applications.

Table 3 AL. OUT1 Pin Alarm Output

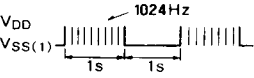
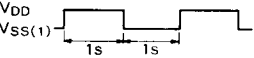
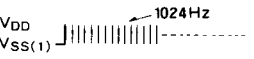
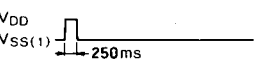
A ₁	A ₂	Output waveform of AL. OUT1	Main applications
N.C.	N.C.		Operation of bells, buzzers and other sound sources without oscillator circuits (intermittent sound)
V _{DD}	N.C.		Operation of sound sources with oscillator circuits (intermittent sound)
N.C.	V _{DD}		Operation of sound sources without oscillation circuits (continuous sound)
V _{DD}	V _{DD}		Switching of electronic apparatus

A₃ Pin

This pin controls mode shifts between normal-clock ordinary-display mode, alarm-time display mode, and sleep-time display mode by the S₃ pin. When the A₃ pin is not connected (N.C.), it operates in the alarm-time display mode so long as the S₃ pin is at the V_{DD} level. When the S₃ pin is disconnected from the V_{DD} contact, the S₃ pin enters the normal-clock ordinary-display mode, but not the sleep-time display mode. When the A₃ pin is at the V_{DD} level, mode shifts occur cyclically in the sequence: normal-clock ordinary display; alarm-time display; sleep-time display; and normal-clock ordinary display, each time the S₃ pin is momentarily at the V_{DD} level.

12/24 Pin

Bringing the 12/24-hour pin to the V_{DD} level turns the 12-hour cycle display into the 24-hour cycle display.

T₁, T₂ and T₃ Pins

The T₃ pin is a clock-input pin for high-speed test use. Combinations of T₁ and T₂ pin potentials control the test mode and options, as shown in Table 4.

Table 4 Test Mode

T ₁	T ₂	Mode
N.C.	N.C.	Normal operation
V _{DD}	N.C.	Normal-clock ordinary display with the colon kept ON (without colon on-off flash)
N.C.	V _{DD}	The counter is reset and 'AM 12:00' (0:00 for 24-hour cycle) is displayed in the normal-clock ordinary-display mode. Here, the alarm time is AM 12:00 (0:00 for 24-hour cycle) and the sleep time is 59 minutes
V _{DD}	V _{DD}	Carryover from the minute to the hour digits is prohibited. The common output is held at the V _{SS} (2) level, and the segment and mark output for display is at the V _{DD} level. High-speed testing is possible.

OUTPUT PINS

Output Pins for Segments, COM, COM AL. MARK, and SL. MARK

The COM output pin common signal has a frequency of 32Hz. Segments and mark-output pins which are not displayed give common signals, while segments and mark output pins displayed give inverse-phase signals of common signals. The COM output is used for permanently-displayed segments or marks.

AL. OUT1 (Alarm output 1) Pin

When the normal-clock ordinary-display time coincides with the alarm time, alarm signals with the waveforms shown in Table 3 are generated at the AL. OUT1 pin for 12 minutes. The 250 ms pulse-width alarm output, however, is given only once after the coincidence.

Coincidence in the alarm-time display mode causes the AL. OUT1 to be given for one minute. When they coincide in the normal-clock time-adjustment mode, continuous alarm signals are generated until the time is advanced.

AL. OUT2 (Alarm Output 2) Pin

When both the A₁ and A₂ pins are at the V_{DD} level (when the AL. OUT1 is the 250 ms pulse-width alarm output), the AL. OUT2 pin gives a DC output for 110~120 min. In cases of the alarm-time minute digit set to integral multiples of 10 minutes from 10 to 50 min., a DC output is sent out for 120 min. This signal is useful for controlling electronic apparatus for 2-hour auto-recording. When both the A₁ and A₂ pins are at other than the V_{DD} level, a DC output is given for 11~12 min by the AL. OUT2 pin.

Fig. 2 Alarm output waveforms

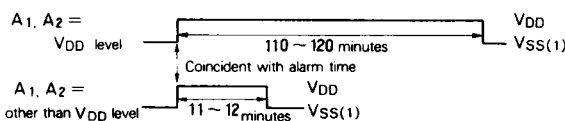

10

CMOS LCD DIGITAL ALARM CLOCK CIRCUITS

SL. OUT (Sleep Output) Pin

This pin can be used not only for sleep timers but also for turning on and off radios, TVs, cassette decks, and VTRs. In the normal-clock ordinary-display mode, the SL. OUT pin can be brought to the V_{DD} level, i.e., the switch-on stage, by starting the sleep timer with the S_1 pin, or by bringing the S_6 pin potential momentarily to V_{DD} after 12 minutes' issuance of the alarm signal or when the 'snooze' function is not in operation. As soon as the sleep time becomes 59 minutes in the normal-clock ordinary-display mode (the sleep timer does not display the time elapsed), or by bringing the S_2 -pin potential momentarily to V_{DD} in the normal-clock ordinary-display mode, the switch-off state, i.e., the $V_{SS(1)}$ level, holds. Fig. 3 shows SL. OUT-pin output waveforms: (1) when the switched-off state is entered at the sleep time set; (2) when the timer is stopped after the start of the sleep timer and started again; and (3) when the switched-off state is entered before the sleep time set. Input pins to be used are shown in parentheses. When the sleep output is turned to the V_{DD} level by using the S_6 pin, this level is maintained unless the sleep timer is started with the S_1 pin. Use of the SL. OUT pin as a maximum 60-minute auto-recording pin requires that both the A_1 and A_2 pin potentials are set to V_{DD} and the AL. OUT1 pin is connected with the S_1 pin as shown in Fig. 7. In this case, sleep output assumes the V_{DD} level when the alarm time coincides with the normal time.

Fig. 3 SL. OUT output waveforms

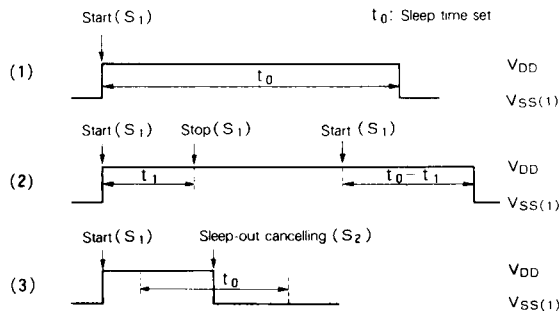

POWER CIRCUITS

V_{DD} , $V_{SS(1)}$, $V_{SS(2)}$, CF, and CT Pins

The electrical power supply is a 1.5V battery ($=V_{DD}-V_{SS(1)}$). Use of $0.1\mu F$ condensers between the CF and CT pins and between the $V_{SS(2)}$ and $V_{DD(GND)}$ pins gives voltage about double the power voltage, making possible direct operation of the LCD.

BD (Battery Detector) Pin

By connecting a resistor between the BD and $V_{SS(1)}$ pins which has a proper temperature characteristic and a resistance between $15k\Omega$ and 750Ω , the segments and marks displayed flash on and off in a 2sec period, a visual reminder of the necessity to replace the battery, when the battery

voltage drops to any specified level in the detectable voltage range of $V_{DD}=-1.2\sim-1.5V$. This flashing can be stopped by making the S_6 potential momentarily V_{DD} . However, it will start again at the next sampling time (max. one minute later) until the battery is replaced.

OPERATIONAL METHODS

Fig. 4 Operation when the A_3 Pin is N.C.

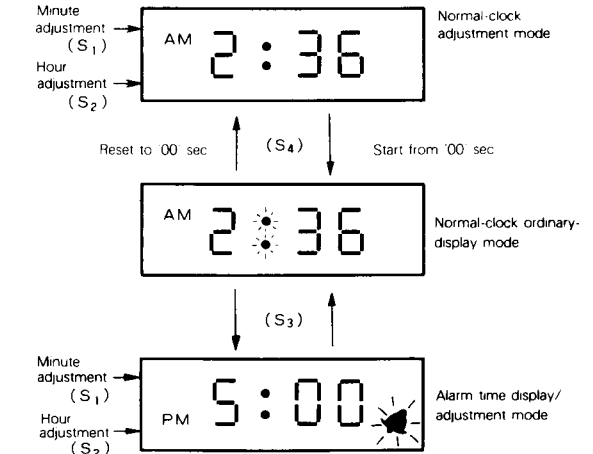

Note 3: The symbol ⌘ shows a 2sec-period on-off flash
4: Lock switches are used in the S_3 , S_4 and S_5 pins

Fig. 5 Operation when the A_3 pin is at the V_{DD} level

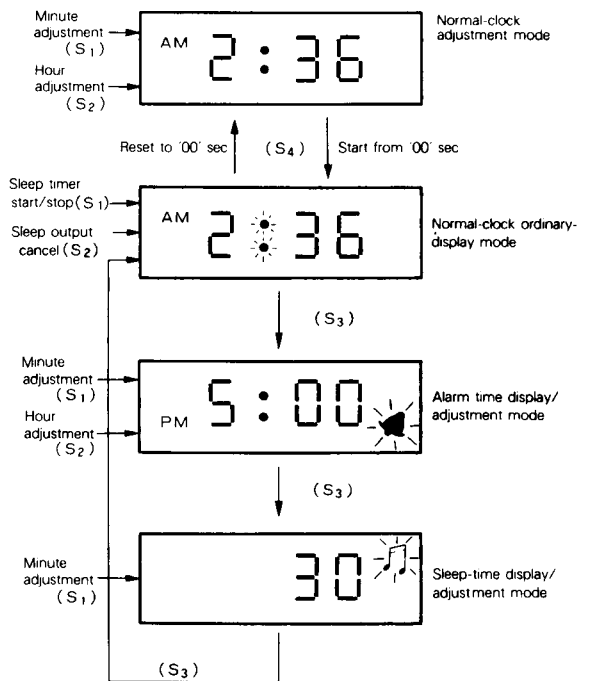

Note 5: The symbol ⌘ shows a 2sec-period on-off flash
6: Lock switches are used in the S_4 and S_5 pins.

CMOS LCD DIGITAL ALARM CLOCK CIRCUITS

ABSOLUTE MAXIMUM RATINGS

Symbol	Parameter	Conditions	Limits	Unit
V _{SS(1)}	Supply voltage	V _{DD} = GND T _a = 25°C	0.1 ~ -3	V
V _{SS(2)}	Supply voltage		0.1 ~ -7	V
V _{I(1)}	Input voltage for V _{SS(1)} supply		V _{SS(1)} ~ V _{DD}	V
V _{I(2)}	Input voltage for V _{SS(2)} supply		V _{SS(2)} ~ V _{DD}	V
T _{opr}	Operating free-air ambient temperature range		-20 ~ 65	°C
T _{stg}	Storage temperature range		-30 ~ 80	°C

RECOMMENDED OPERATING CONDITIONS (T_a = 25°C, except where otherwise specified)

Symbol	Parameter	Conditions (Note 6)	Limits			Unit	
			Min	Nom	Max		
V _{SS(1)}	Supply voltage	M58412P	C _{IN} = 15pF, C _{OUT} = 10pF, R _O = 20Ω	-1.2	-1.5	-1.9	V
		M58413P	C _{IN} = 15pF, C _{OUT} = 30pF, R _O = 30kΩ	-1.1	-1.5	-2	V
V _{SS(2)}	Supply voltage	M58412P	C _{IN} = 15pF, C _{OUT} = 10pF, R _O = 20Ω	-2.4	-3	-3.8	V
		M58413P	C _{IN} = 15pF, C _{OUT} = 30pF, R _O = 30kΩ	-2.2	-3	-4	V

ELECTRICAL CHARACTERISTICS

(T_a = 25°C, V_{DD} = GND, M58412P: f = 4.1943MHz, M58413P: f = 32.768kHz, except where otherwise specified)

Symbol	Parameter	Test conditions (Note 6)	Limits			Unit	
			Min	Typ	Max		
I _{DD}	Supply current from V _{DD}	M58412P	V _{SS(1)} = -1.5V, C _{IN} = 15pF, C _{OUT} = 10pF C ₁ = C ₂ = 0.1μF, R _O = 20Ω		30	80	μA
		M58413P	V _{SS(1)} = -1.5V, C _{IN} = 15pF, C _{OUT} = 30pF C ₁ = C ₂ = 0.1μF, R _O = 30kΩ		2	5	μA
V _{I(OSC)}	Oscillator input voltage	M58412P	C _{IN} = 15pF, C _{OUT} = 10pF, R _O = 20Ω within 1sec of oscillation			-1.2	V
		M58413P	C _{IN} = 15pF, C _{OUT} = 30pF, R _O = 30kΩ within 5sec of oscillation			-1.2	V
I _{OL(COM)}	Low-level output current (common)	V _{SS(2)} = -3V, V _{OL} = -2.9V	30			μA	
I _{OH(COM)}	High-level output current (common)	V _{SS(2)} = -3V, V _{OH} = -0.1V	-30			μA	
I _{OL(SEG)}	Low-level output current (segment)	V _{SS(2)} = -3V, V _{OL} = -2.9V	5			μA	
I _{OH(SEG)}	High-level output current (segment)	V _{SS(2)} = -3V, V _{OH} = -0.1V	-5			μA	
I _{OL(AL)}	Low-level output current (alarm, sleep)	V _{SS(1)} = -1.5V, V _{OL} = -1V	100			μA	
I _{OH(AL)}	High-level output current (alarm, sleep)	V _{SS(1)} = -1.5V, V _{OH} = -0.5V	-100			μA	
I _{IL}	Low-level input current	V _{SS(1)} = -3V, V _{IL} = -3V except for test input terminals				-0.2	μA
I _{IH}	High-level input current	V _{SS(2)} = -3V, V _{IH} = 0V except for test input terminals				0.2	μA
V _{O(2)}	Doubler output voltage	V _{SS(1)} = -1.5V, C ₁ = C ₂ = 0.1μF I _O = 2μA	-2.8			V	
V _{I(BD)}	Battery detector voltage range	15kΩ ≤ R _{BD} ≤ 750kΩ	-1.2			-1.5	V

Note 7: R_O refers to a crystal impedance.

10

M58412P, M58413P

CMOS LCD DIGITAL ALARM CLOCK CIRCUITS

TYPICAL APPLICATION CIRCUITS

Fig. 6 An alarm clock with 'snooze' and sleep functions

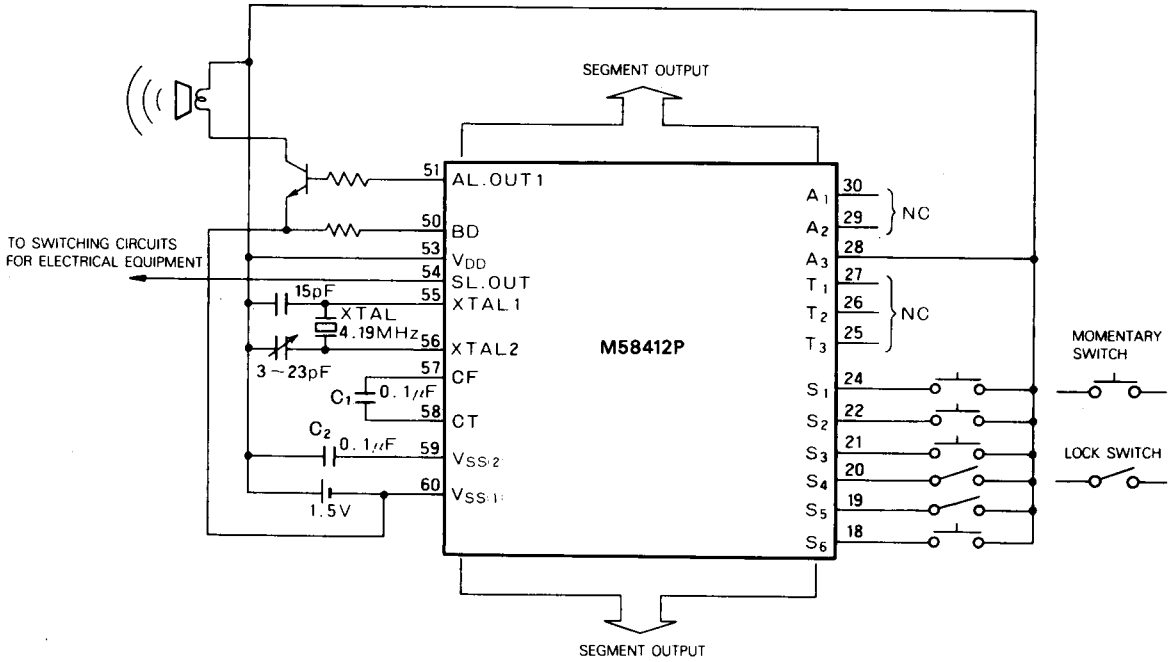
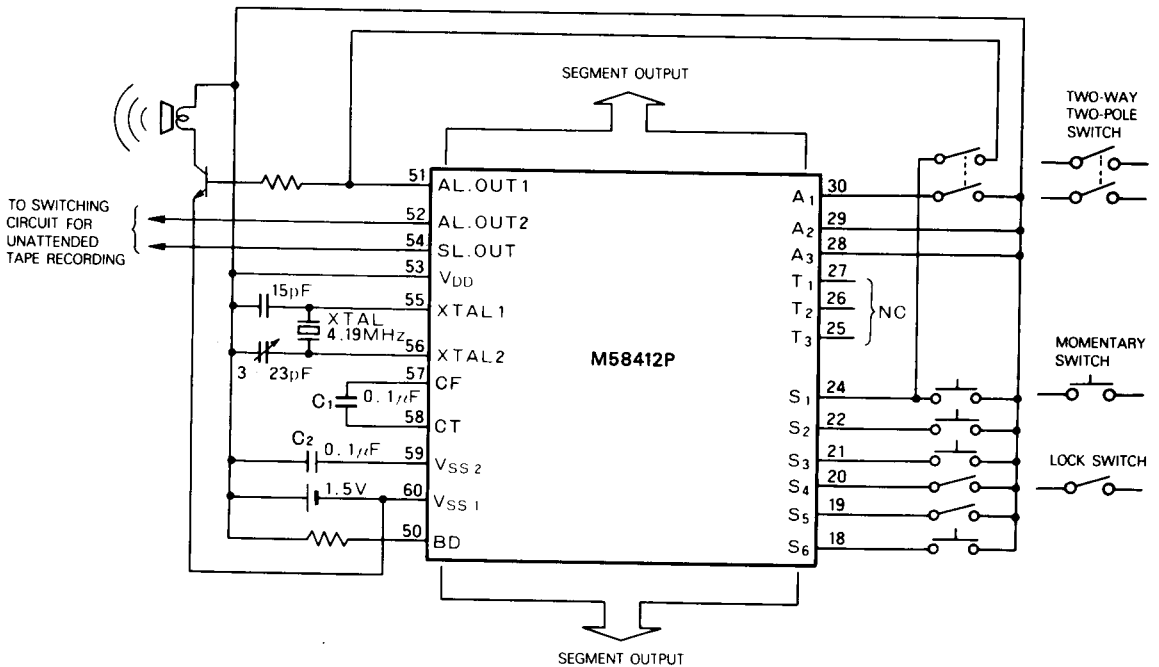

Fig. 7 An alarm clock with 'snooze' and auto-recording functions



Note 8 : The circuit of Fig. 6 gives intermittent alarm-bell tones.

9 : The circuit of Fig. 7 gives continuous alarm-bell tones.

10 : Use of Type M58413P in Fig. 6 and Fig. 7 requires the employment of a 32kHz quartz oscillator and a 5 ~ 35pF variable condenser.

Note 11 : Use is made of AL. OUT2 for 110 ~ 120 minute fixed-time auto-recording output and of the SL. OUT pin for maximum 60 minute non-fixed-time auto-recording output