

To all our customers

Regarding the change of names mentioned in the document, such as Mitsubishi Electric and Mitsubishi XX, to Renesas Technology Corp.

The semiconductor operations of Hitachi and Mitsubishi Electric were transferred to Renesas Technology Corporation on April 1st 2003. These operations include microcomputer, logic, analog and discrete devices, and memory chips other than DRAMs (flash memory, SRAMs etc.) Accordingly, although Mitsubishi Electric, Mitsubishi Electric Corporation, Mitsubishi Semiconductors, and other Mitsubishi brand names are mentioned in the document, these names have in fact all been changed to Renesas Technology Corp. Thank you for your understanding. Except for our corporate trademark, logo and corporate statement, no changes whatsoever have been made to the contents of the document, and these changes do not constitute any alteration to the contents of the document itself.

Note : Mitsubishi Electric will continue the business operations of high frequency & optical devices and power devices.

Renesas Technology Corp.
Customer Support Dept.
April 1, 2003

DESCRIPTION

M62237FP is constant voltage/current control IC with high accuracy ref. voltage(1.25V+/-1.0%) suitable for secondary side control for charger and switching power supply.

Built-in OP Amps for voltage/current control and external output terminal for current control OP Amp. allow for phase compensation.

FEATURES

- Operating power supply voltage range—2.5-15V
- High accuracy ref. voltage—1.25V+/-1.0%
- PC terminal output current—20mA

APPLICATION

- Secondary side control for charger and switching power supply

PIN CONFIGURATION(TOP VIEW)

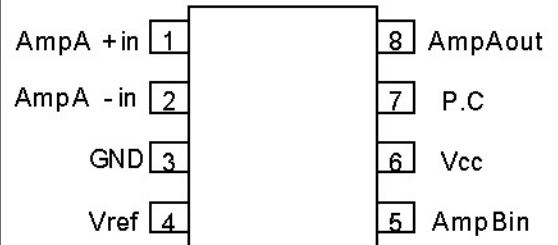

OUTLINE 8P2S-A

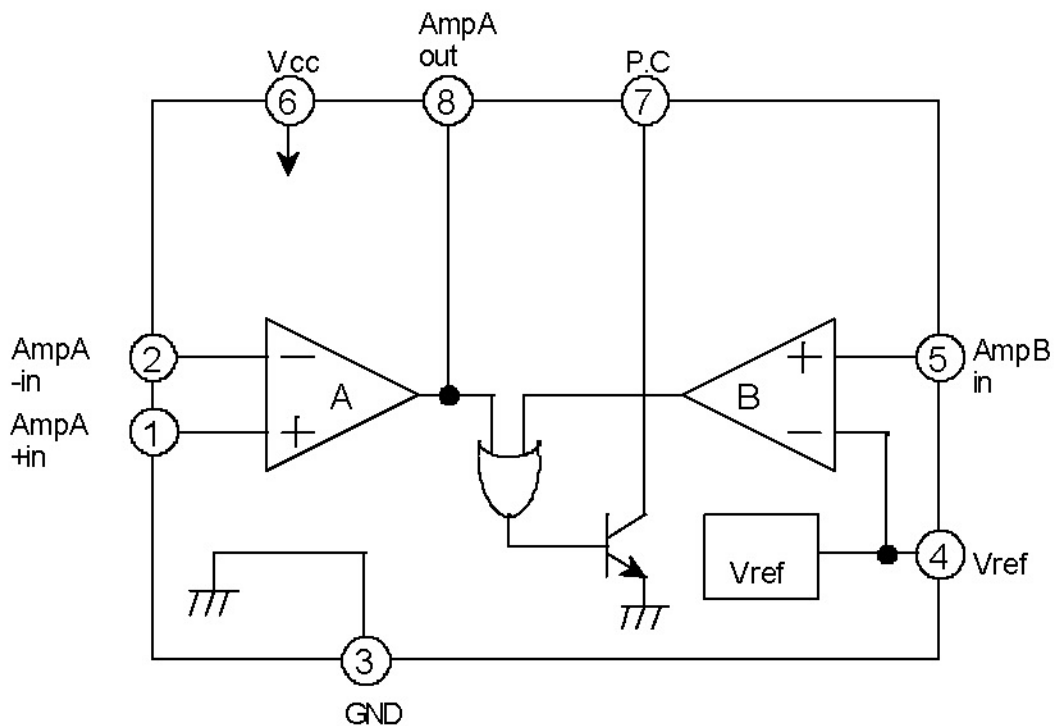

M62237FP

CONSTANT VOLTAGE CONSTANT CURRENT CONTROL IC

ABSOLUTE MAXIMUM RATINGS(Ta=25deg.,unless otherwise specified.)

Symbol	Parameter	Conditions	Ratings	Unit
Vcc	Supply voltage		16	V
VP.C	P.C terminal voltage		16	V
IP.C	P.C terminal input current		20	mA
Iref.	Vref terminal output current		5	mA
VID	Input differential voltage	Amp.A	16	V
		Amp.B	9	V
Pd	Power dissipation		440	mW
K θ	Thermal derating	Ta \square 25deg.	4.4	mW/deg.
Topr.	Operating temperature		-20~75	deg.
Tstg.	Storage temperature		-40~125	deg.

ELECTRICAL CHARACTERISTICS (Vcc=6V, Ta=25deg. unless otherwise specified.)

	Symbol	Parameter	Conditions	Ratings			Unit
				MIN.	TYP.	MAX.	
ALL	Vcc	Supply voltage		2.5	—	15	V
	Icc	Supply current	IP.C=0,Iref=0		0.8		mA
	Vref	Ref.voltage	Iref=0,IP.C=5mA	1.237	1.25	1.263	V
	Δ Vref	Ref.voltage regulation	Iref=0~2mA	—	10	30	mV
P.C	Vsat	P.C terminal sat. volt.	IP.C=10mA	—	0.2	0.4	v
	IP.CLEAK	P.C terminal leak current	VP.C=6V	—	—	2	μ A
AMP.A(Note1)	VIO	Input offset voltage		—	0.5	2.5	mV
	IB+,IB-	Input bias current		—	-100	—	nA
	VICM	Common mode input volt.	IP.C=5mA	0	—	4.0	V
	GVO	Open voltage gain		—	80	—	dB
	CMRR	Common mode rejection ratio		—	70	—	dB
	SVRR	Supply voltage rejection ratio		—	70	—	dB
	SR	Slew rate		—	0.5	—	V/ μ sec
AMP.A(Note2)	VOM	Output voltage range		0.9	—	1.9	V
	Isource	Output source current		—	-20	—	μ A
	Isink	Output sink current		—	100	—	μ A
AMP.B(Note3)	VIO	Input offset voltage		—	0.5	3.0	mV
	IB+	Input bias current		—	-100	—	nA
	GVO	Open voltage gain		—	80	—	dB
	SVRR	Supply voltage rejection ratio		—	70	—	dB
	SR	Slew rate		—	0.5	—	V/ μ sec

Note1. Amp A+in,-in terminal for input, PC terminal for output

Note2. Amp A+in,-in terminal for input,Amp A out terminal for output

Note3. Amp B+in,-in terminal for input, PC terminal for output

Typical characteristics(Ta=25deg., Vcc=6V unless otherwise noted.)

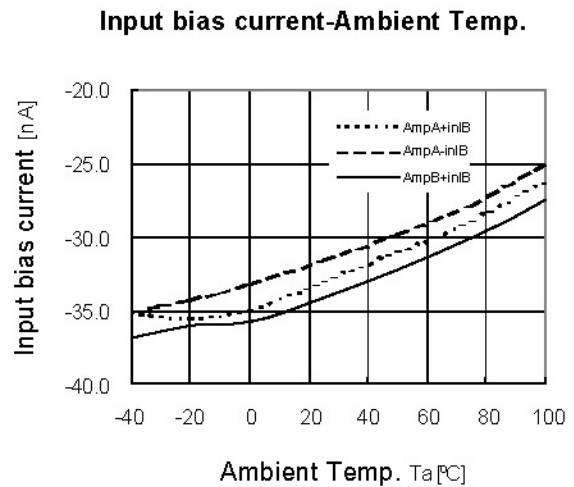
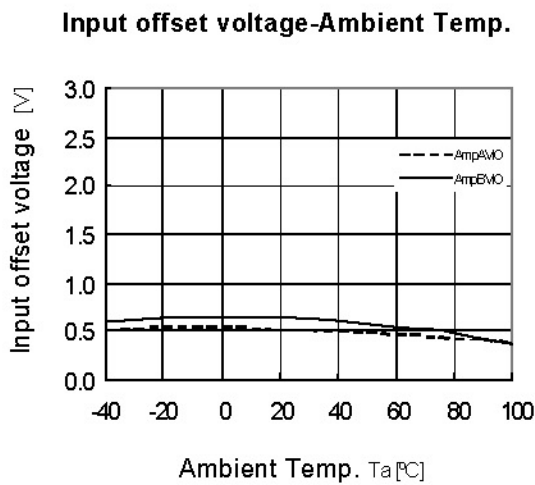
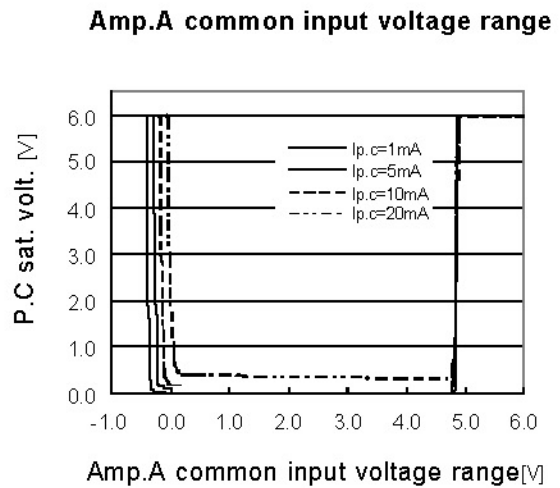
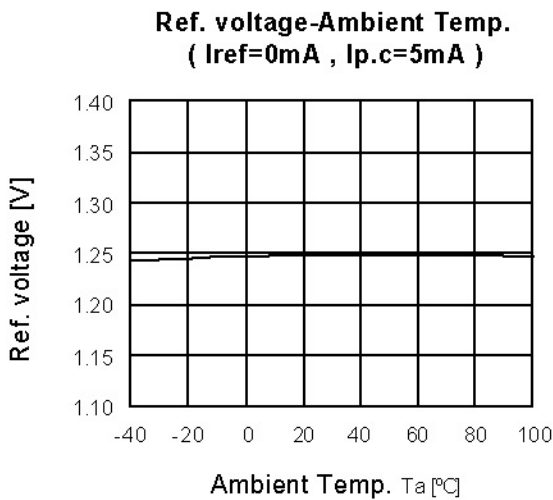
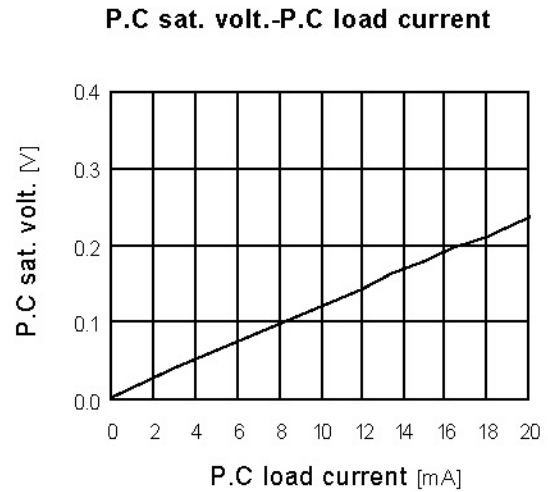
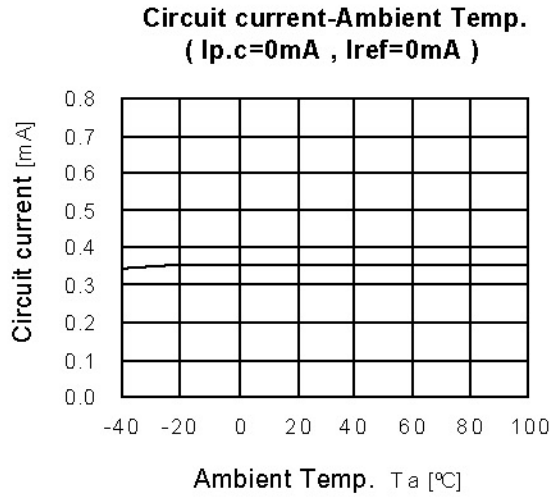

M62237FP

CONSTANT VOLTAGE CONSTANT CURRENT CONTROL IC

M62237FP APPLICATION DIAGRAM(with switching mode power supply)

