

**M63830P/FP**

4-UNIT 1.5A DARLINGTON TRANSISTOR-ARRAY WITH CLAMP DIODE

**DESCRIPTION**

The M63830P/FP 4-channel sinkdriver, consists of 4 PNP and 8 NPN transistors connected to form four high current gain driver pairs.

**FEATURES**

- High breakdown voltage ( $BV_{CEO} \geq 50V$ )
- High-current driving ( $I_{C(max)} = 1.5A$ )
- 3V micro computer series compatible input
- With clamping diodes
- With input diode
- Wide operating temperature range ( $T_a = -40$  to  $+85^\circ C$ )

**APPLICATION**

Output for 3 voltage microcomputer series and interface with high voltage system. Relay and small printer driver, LED, or incandescent display digit driver.

**FUNCTION**

The M63830FP/P is transistor-array of high active level four units type which can do direct drive of 3 voltage microcomputer series. A resistor of  $3.5k\Omega$  is connected between the input and the base of PNP transistors. A clamp diode for inductive load transient suppression is connected for the output pin (collector) and COM pin. The input diode is intended to prevent the flow of current from the input to the  $V_{CC}$ . Without this diode, the current flows from "H" input to the  $V_{CC}$  and the "L" input circuit is activated, in such a case where one of the inputs of the 4 circuit is "H" and the other are "L" to save power consumption. The diode is inserted to prevent such mis-operation. The outputs are capable of driving 1.5A and are rated for operation with output voltage up to 50V.

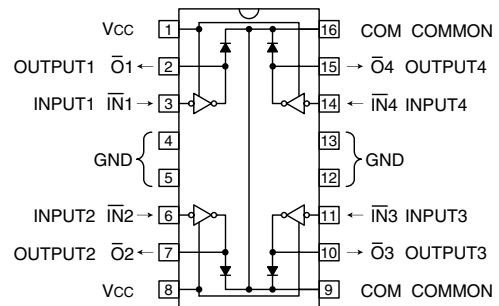
**PIN CONFIGURATION**

16P4(P)

Package type 16P2N-A(FP)

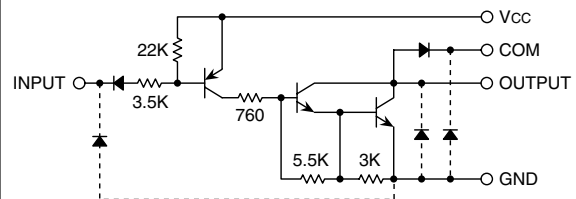
**CIRCUIT DIAGRAM**

The four circuits share the COM and GND

The diode, indicated with the dotted line, is parasitic, and cannot be used.

Unit :  $\Omega$ **ABSOLUTE MAXIMUM RATINGS** (Unless otherwise noted,  $T_a = -40 \sim +85^\circ C$ )

Symbol	Parameter	Conditions	Ratings	Unit
$V_{CC}$	Supply voltage		7	V
$V_{CEO}$	Collector-emitter voltage	Output, H	$-0.5 \sim +50$	V
$I_C$	Collector current	Current per circuit output, L	1.5	A
$V_I$	Input voltage		$-0.5 \sim V_{CC}$	V
$V_R$	Clamping diode reverse voltage		50	V
$I_F$	Clamping diode forward current	Pulse width $\leq 10ms$ , duty cycle $\leq 5\%$	1.5	A
		Pulse width $\leq 100ms$ , duty cycle $\leq 5\%$	1.0	
$P_d$	Power dissipation	$T_a = 25^\circ C$ , when mounted on board	1.92(P)/1.00(FP)	W
$T_{opr}$	Operating temperature		$-40 \sim +85$	$^\circ C$
$T_{stg}$	Storage temperature		$-55 \sim +125$	$^\circ C$

Sep. 2001

**PRELIMINARY**  
 Notice: This is not a final specification.  
 Some parametric limits are subject to change.

4-UNIT 1.5A DARLINGTON TRANSISTOR-ARRAY WITH CLAMP DIODE

**RECOMMENDED OPERATING CONDITIONS** (Unless otherwise noted, Ta = -40 ~ +85°C)

Symbol	Parameter	Limits			Unit	
		min	typ	max		
Vcc	Supply voltage	2.7	3.0	3.6	V	
Vo	Output voltage	0	—	50	V	
Ic	Collector current (Current per 1 circuit when 4 circuits are coming on simultaneously)	Vcc = 3V, Duty Cycle P : no more than 5% FP : no more than 2%	0	—	1.25	A
		Vcc = 3V, Duty Cycle P : no more than 15% FP : no more than 7%	0	—	0.7	
VIH	"H" input voltage	Vcc-0.5	—	Vcc	V	
VIL	"L" input voltage	0	—	Vcc-2.2	V	

**ELECTRICAL CHARACTERISTICS** (Unless otherwise noted, Ta = -40 ~ +85°C)

Symbol	Parameter	Test conditions	Limits			Unit
			min	typ*	max	
V (BR) CEO	Collector-emitter breakdown voltage	ICEO = 100μA	50	—	—	V
ICC	Supply current (AN only Input)	VCC = 3.6V, Vi = 0.5V	—	3.7	5.0	mA
VCE(sat)	Collector-emitter saturation voltage	VCC = 2.7V, Vi = 0.5V, Ic = 1.25A	—	1.4	2.2	V
		VCC = 2.7V, Vi = 0.5V, Ic = 0.7A	—	1.0	1.7	
Ii	Input current	Vi = Vcc-2.2V	—	-0.22	-0.6	mA
		Vi = Vcc-3.6V	—	-0.60	-0.95	
IR	Clamping diode reverse current	VR = 50V	—	—	100	μA
VF	Clamping diode forward voltage	IF = 1.25A, Vcc open	—	1.5	2.3	V
hFE	DC amplification factor	VCC = 2.7V, VCE = 2V, Ic = 1A, Ta = 25°C	4000	30000	—	—

\* : Typical values are at Ta = 25°C

**SWITCHING CHARACTERISTICS** (Unless otherwise noted, Ta = 25°C)

Symbol	Parameter	Test conditions	Limits			Unit
			min	typ	max	
ton	Turn-on time	CL = 15pF (note 1)	—	190	—	ns
toff	Turn-off time		—	5300	—	ns

**NOTE 1 TEST CIRCUIT**

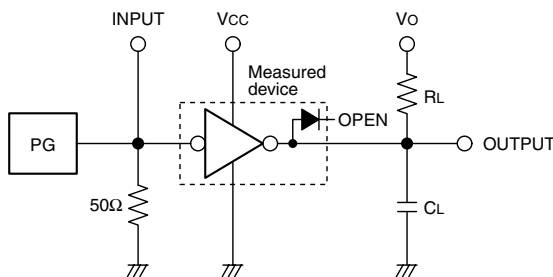

- (1) Pulse generator (PG) characteristics : PRR=1kHz, tw = 10μs, tr = 6ns, tf = 6ns, Zo = 50Ω, Vi = 0.5 ~ 2.7V
- (2) Input-output conditions : RL = 8.3Ω, Vo = 10V, Vcc = 2.7V
- (3) Electrostatic capacity CL includes floating capacitance at connections and input capacitance at probes

**TIMING DIAGRAM**

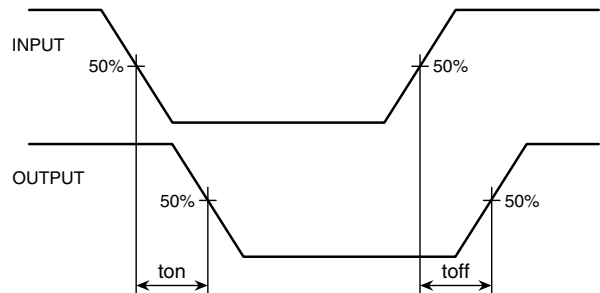

**PRELIMINARY**  
 Notice: This is not a final specification.  
 Some parametric limits are subject to change.

4-UNIT 1.5A DARLINGTON TRANSISTOR-ARRAY WITH CLAMP DIODE

TYPICAL CHARACTERISTICS

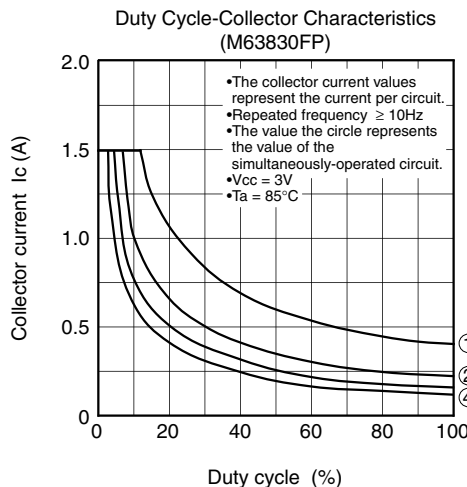
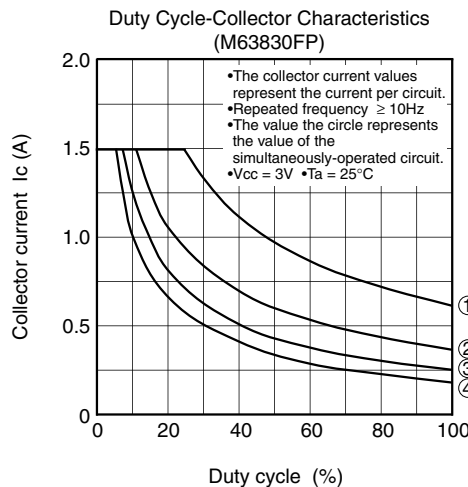
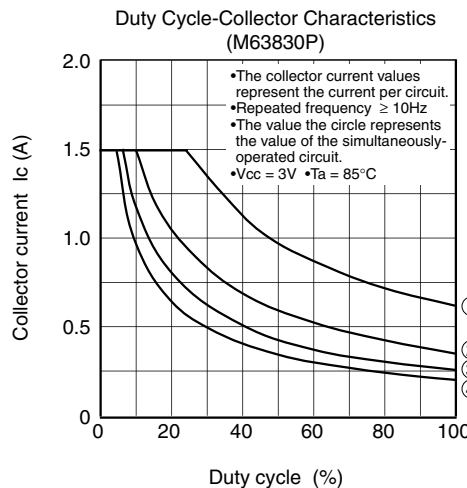
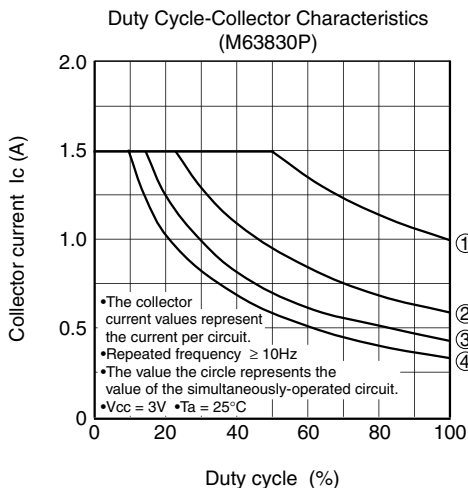
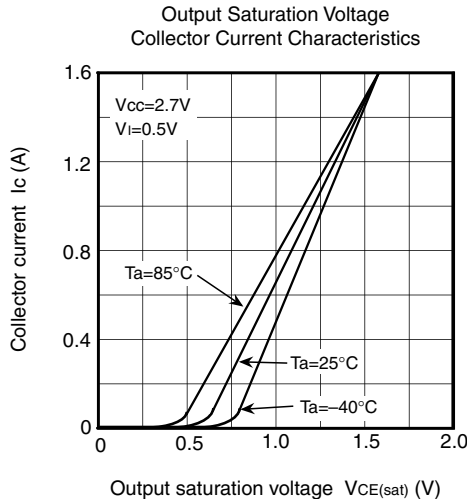
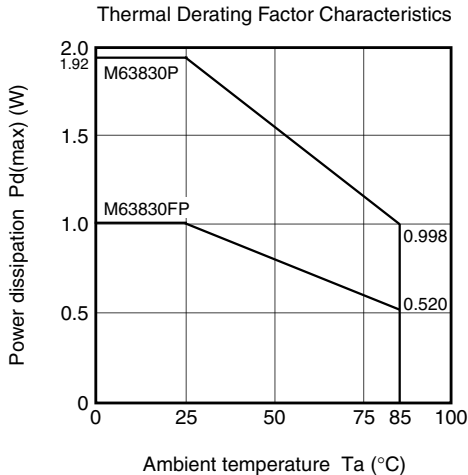

**PRELIMINARY**  
 Notice: This is not a final specification.  
 Some parametric limits are subject to change.

4-UNIT 1.5A DARLINGTON TRANSISTOR-ARRAY WITH CLAMP DIODE

DC Amplification Factor  
 Collector Current Characteristics

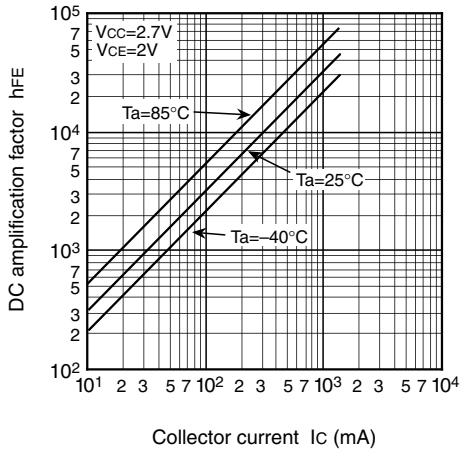

Grounded Emitter Transfer Characteristics

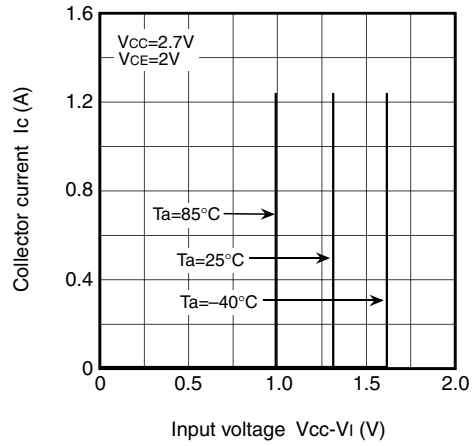

Input Characteristics

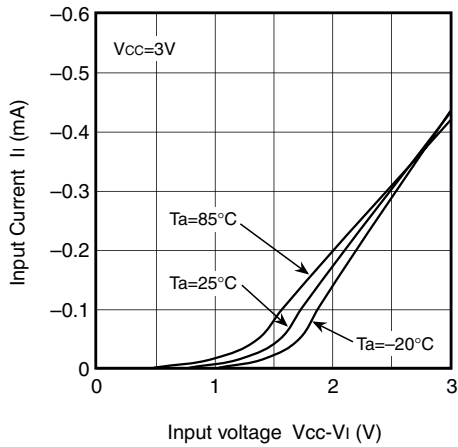

Clamping Diode Characteristics

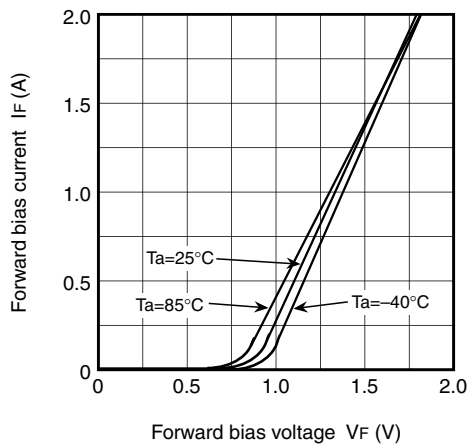

Driver Supply Characteristics

