

M65575FP

Rhythm Phrase Player

REJ03F0169-0201

Rev.2.01

Jan 25, 2008

Description

The M65575FP is suitable for rhythm phrase reproduce LSI thanks to the internal music sources and rhythm patterns.

The M65575FP contains music sources which maximum counts are 256, also contains rhythm patterns which maximum counts are 64.

Features

[Music Source]	Features
Compression algorithm	4 bit ADPCM
Maximum music sources	256
Sampling frequency	4 kHz/8 kHz/16 kHz/32 kHz
Pronunciation counts	3 tracks (Monaural; at the same time)
[Rhythm]	
Maximum rhythm patterns	64 patterns
Tempo	60 to 240 step 1
Resolution ratio	16 beat
[System]	
Power supply	3.3 V single power supply
Output	Stereo (L/R) capable of both setting GAIN and Attenuate ATT: 0 dB, -6 dB, -12 dB, -18 dB, -24 dB, -30 dB, -36 dB, -∞ dB GAIN: 6.0 dB, 5.5 dB, 4.9 dB, 4.2 dB, 3.5 dB, 2.8 dB, 1.9 dB, 1.0 dB
Pan pot	Capable of set each music sources of rhythm patterns (11 steps)
Level	Capable of set each music sources of rhythm patterns (0 dB, -6.0 dB, -9.3 dB, -12 dB, -15.3 dB, -21.3 dB, -∞ dB)
Music sources ROM size	1.5 Mbit
Rhythm patterns ROM size	96 Kbit
MCU I/F	4 line serial bus interface (clock, data, latch, read/write)
MCU Commands	Tempo, rhythm pattern setting, GAIN/ATT setting, start, repeat start, stop, PAD commands
[Internal function]	
Fs conversion filter	Input: 4 kHz/8 kHz/16 kHz/32 kHz, Output: 32 kHz
D/A converter	D/A converter 1 Bit $\Delta\Sigma$ converter (PWM output)

Block Diagram

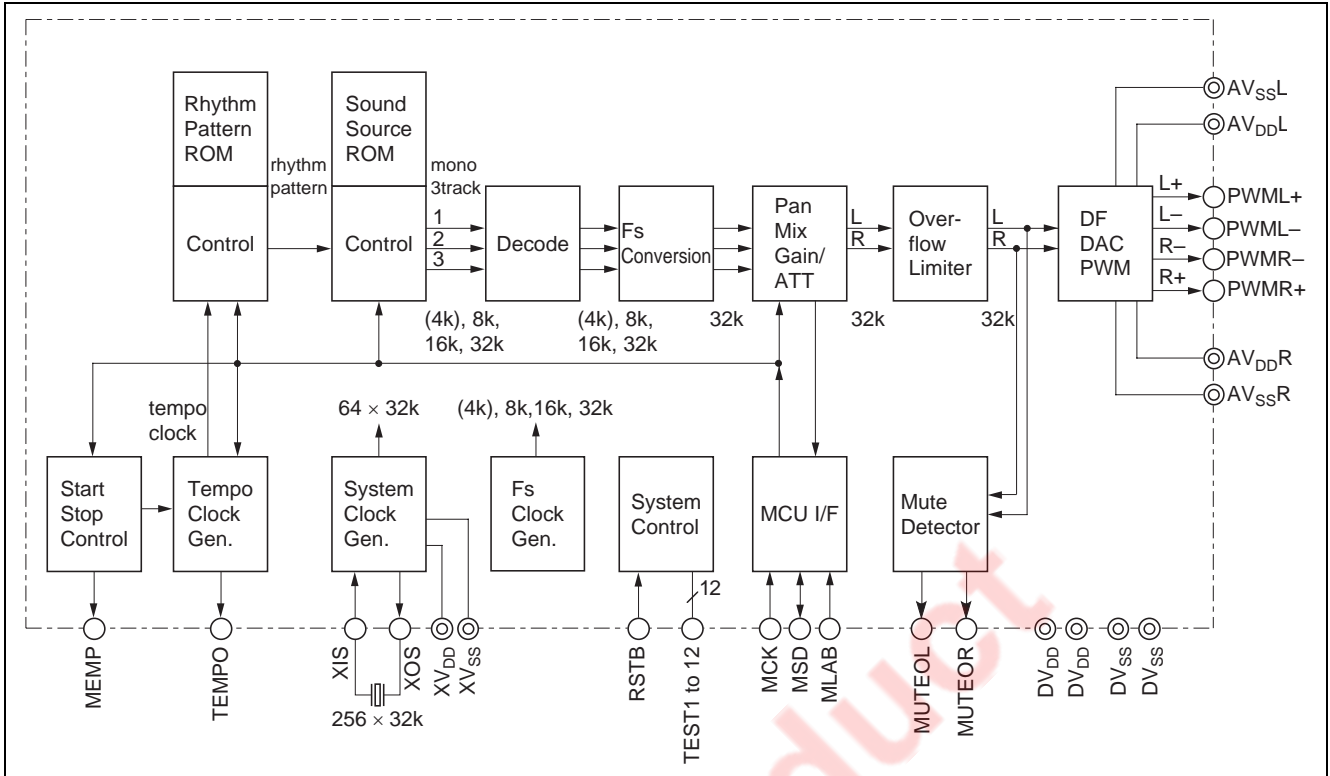

Pin Arrangement

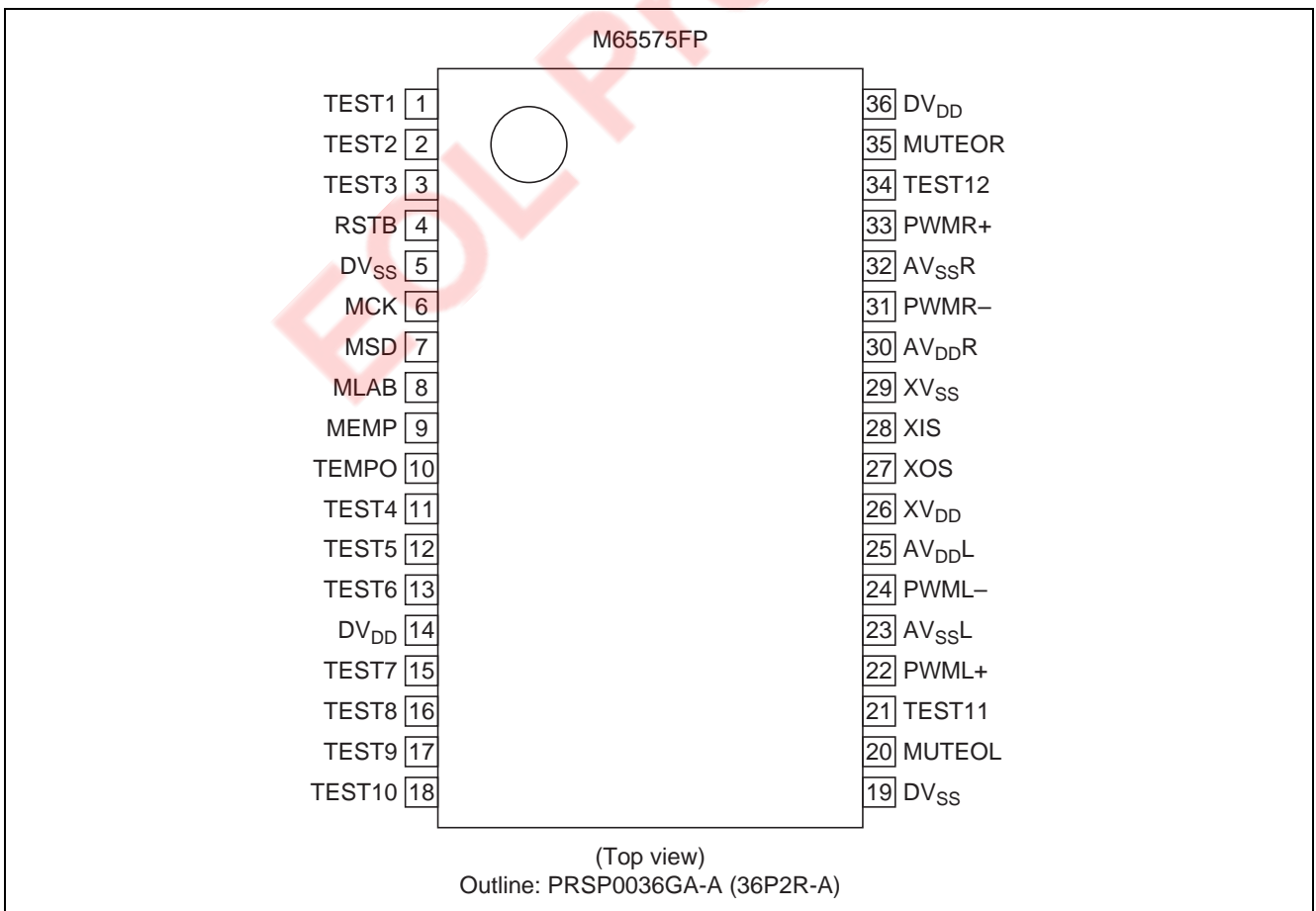

Absolute Maximum Ratings

Item	Symbol	Ratings	Unit
Supply voltage	V_{DD}	4.2	V
Input voltage	V_i	-0.3 to $V_{DD} + 0.3$	V
Power dissipation	P_d	455	mW
Operating temperature	T_{opr}	-20 to +75	°C
Storage temperature	T_{stg}	-40 to +125	°C

Recommended Operating Condition

Item	Symbol	Limits			Unit
		Min	Typ	Max	
Supply voltage	V_{DD}	3	3.3	3.6	V
Oscillation frequency	f_{osc}	—	8.2	—	MHz

DC Characteristics

Item	Symbol	Limits			Unit	Test Conditions
		Min	Typ	Max		
H input voltage	V_{IH}	$0.7 \cdot V_{DD}$	—	V_{DD}	V	
L input voltage	V_{IL}	0	—	$0.3 \cdot V_{DD}$	MHz	
H input leakage current	I_{IH}	-10	—	10	μA	$V_{DD} = 3.6 V, V_i = 3.5 V$
L input leakage current	I_{IL}	-10	—	10	μA	$V_{DD} = 3.6 V, V_i = 0.1 V$
H output voltage (Excluding PWM)	V_{OH}	$V_{DD} - 0.4$	—	V_{DD}	V	$V_{DD} = 3.0 V, I_{OH} = -2 mA$
L output voltage (Excluding PWM)	V_{OL}	0	—	0.4	V	$V_{DD} = 3.0 V, I_{OL} = 2 mA$
Consumption current	I_{DD}	—	5	10	mA	

MCU Command

Input Timing Chart

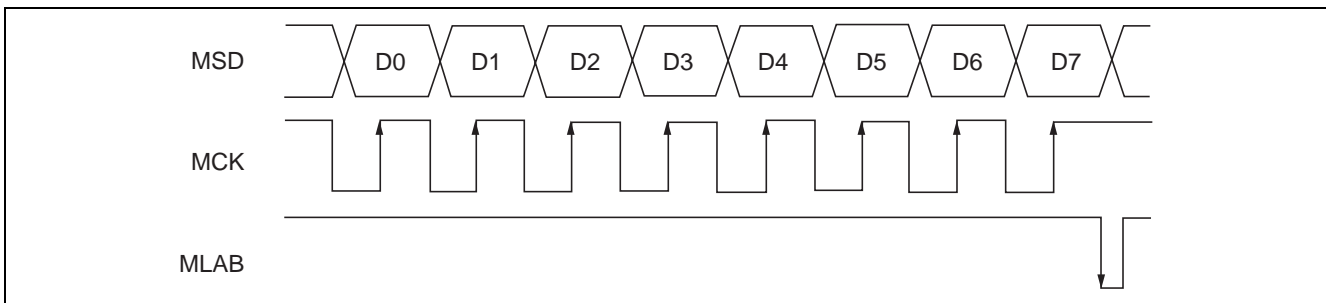

Data Format

There are two setting bytes with MCU commands that are 1 byte command and 2 byte command.

Following are data formats of MCU command.

<1 Byte Command>

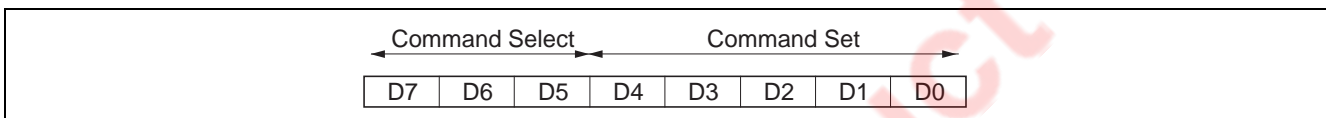

<2 Byte Command>

When using the 2 byte command, please send 1st byte at first and after, send 2nd byte.

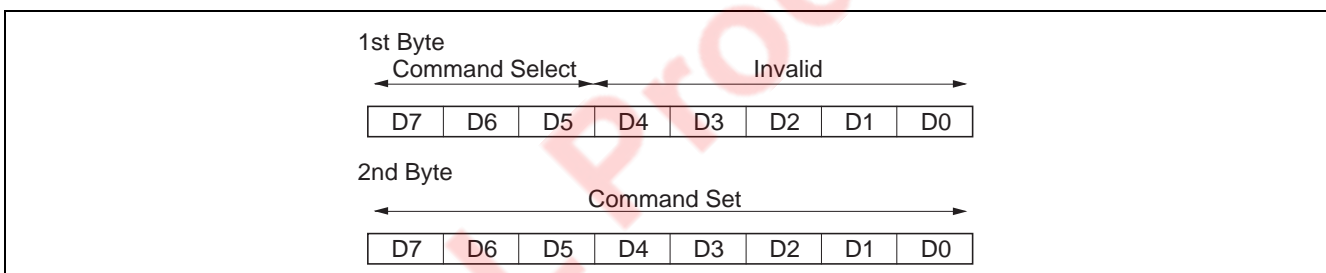

Command Settings

<Parameter Set>

No.	Command	Function	Byte Counts
(1)	Tempo	Tempo setting, Normal: 60 to 160 step 1 Triplet tempo: 90 to 240 step 1	2
(2)	Rhythm pattern select A	Presetting the rhythm pattern from the internal 64 (Max) rhythm pattern. Capable of presetting 3 patterns (A, B, C)	2
(3)	Rhythm pattern select B		
(4)	Rhythm pattern select C		
(5)	Gain/Attenuate level control	Gain/Attenuate level setting 6.0, 5.5, 4.9, 4.2, 3.5, 2.8, 1.9, 1.0, 0, -6, -12, -18, -24, -30, -36, -∞ dB	1

<Start/Stop/Pad Control Set>

No.	Command	Function	Byte Counts
(6)	Start/Stop control	Rhythm start/stop control	1
(7)	PAD control	PAD control (2 systems)	2

<Software Reset/Test Control Set>

No.	Command	Function	Byte Counts
(8)	Reset/Test	Software reset, Test mode (Shipment test)	1

Command Function Explanations

(1) Tempo

() at the first setting mode

Command	Byte No.	Bit Allotment							
		D7	D6	D5	D4	D3	D2	D1	D0
Tempo	1	L	L	L	don't care				
	2	Tempo [7:0] (LHHLLHLL)							

Note: Tempo [7:0]: Tempo setting is following.

Normal: 3C-A0 (Hex) [60-160 (Dec)]

Triplet tempo: 5A-F0 (Hex) [90-240 (Dec)]

(Cannot use another settings)

Capable of the setting 1 step unit.

At the first setting is 64 (Hex) [120 (Dec)].

(2) Rhythm pattern select A

(3) Rhythm pattern select B

(4) Rhythm pattern select C

() at the first setting mode

Command	Byte No.	Bit Allotment							
		D7	D6	D5	D4	D3	D2	D1	D0
Rhythm pattern select A	1	L	L	H	don't care				
	2	don't care		rhythm_pat_sel_a [5:0] (LLLLLL)					
Rhythm pattern select B	1	L	H	L	don't care				
	2	don't care		rhythm_pat_sel_b [5:0] (LLLLLL)					
Rhythm pattern select C	1	L	H	H	don't care				
	2	don't care		rhythm_pat_sel_c [5:0] (LLLLLL)					

Note: rhythm_pat_sel_a [5:0]: Setting the Rhythm pattern A

rhythm_pat_sel_b [5:0]: Setting the Rhythm pattern B

rhythm_pat_sel_c [5:0]: Setting the Rhythm pattern C

You can set the each rhythm pattern (A, B, C) and choose 64 internal patterns (Max).

One of these rhythm patterns starts the play, after you choose one of them and send the start/stop control commands.

(5) Gain/Attenuate level

() at the first setting mode

Command	Byte No.	Bit Allotment							
		D7	D6	D5	D4	D3	D2	D1	D0
Gain/Attenuate level	1	H	L	L	don't care	att [3:0] (HLLL)			

Note: att [3:0]: Setting the output gain and attenuate level.
It sets common setting with Lch and Rch.
Attenuate level control

att				Gain Level [dB]	att				Attenuate Level [dB]
[3]	[2]	[1]	[0]		[3]	[2]	[1]	[0]	
L	L	L	L	+6	H	L	L	L	0
L	L	L	H	+5.5	H	L	L	H	-6
L	L	H	L	+4.9	H	L	H	L	-12
L	L	H	H	+4.2	H	L	H	H	-18
L	H	L	L	+3.5	H	H	L	L	-24
L	H	L	H	+2.8	H	H	L	H	-30
L	H	H	L	+1.9	H	H	H	L	-36
L	H	H	H	+1.0	H	H	H	H	-∞

(6) Start/Stop control

() at the first setting mode

Command	Byte No.	Bit Allotment							
		D7	D6	D5	D4	D3	D2	D1	D0
Start/Stop control	1	H	L	H	pat_sel [1:0] (LL)		start (L)	s_mode (L)	e_mode (L)

Note: Start/Stop control command control the rhythm music start/stop timing.

pat_sel [1:0]: Select the rhythm pattern (A, B or C)
It can select the next rhythm music from rhythm pattern A, B or C.

Rhythm pattern select mode

pat_sel		Rhythm Pattern Select
[1]	[0]	
L	L	Rhythm Pattern A
L	H	Rhythm Pattern B
H	L	Rhythm Pattern C
H	H	Prohibit

start: Control the start/stop timing of rhythm music.
H: Start the rhythm music, L: Stop the music without delay
s_mode: Setting the start mode of rhythm music
H: Chain music start (Start the music after ending the before music)
L: Start music without delay
e_mode: Setting the stop mode of rhythm music
H: Loop reproduction mode (music continuous mode)
L: 1 shot reproduction mode (1 time mode)

Thanks to these commands, we can control the following rhythm play mode.

Rhythm control has two modes,

- One shot start mode and loop start mode which start when the rhythm music is not available
- Chain start, start without delay and stop without delay which control when the rhythm music is playing

Following is an example of rhythm play mode. (off course you can use all pattern A, B, C)

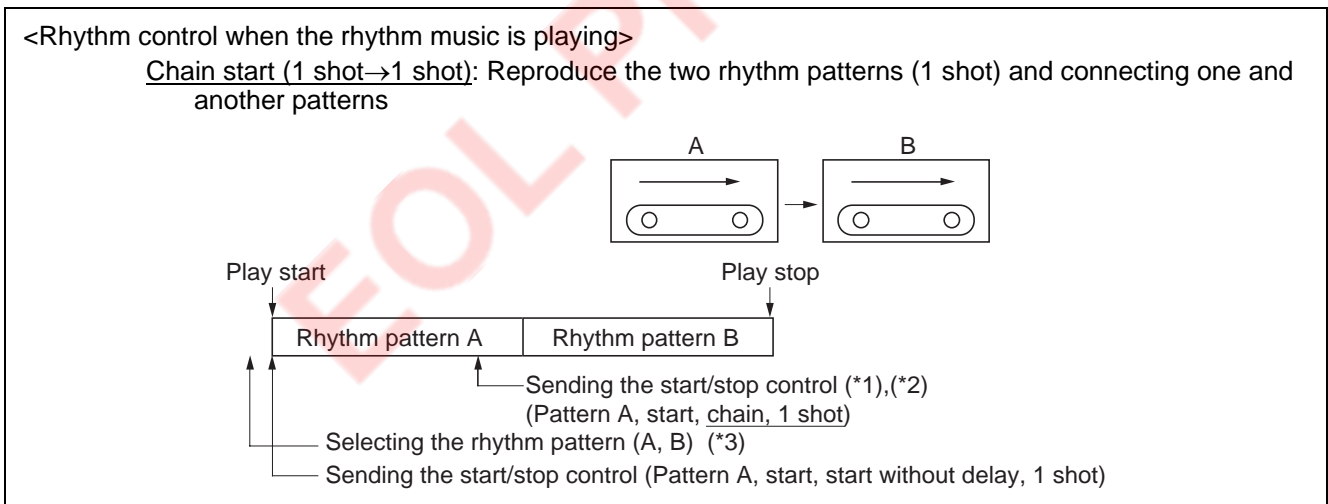
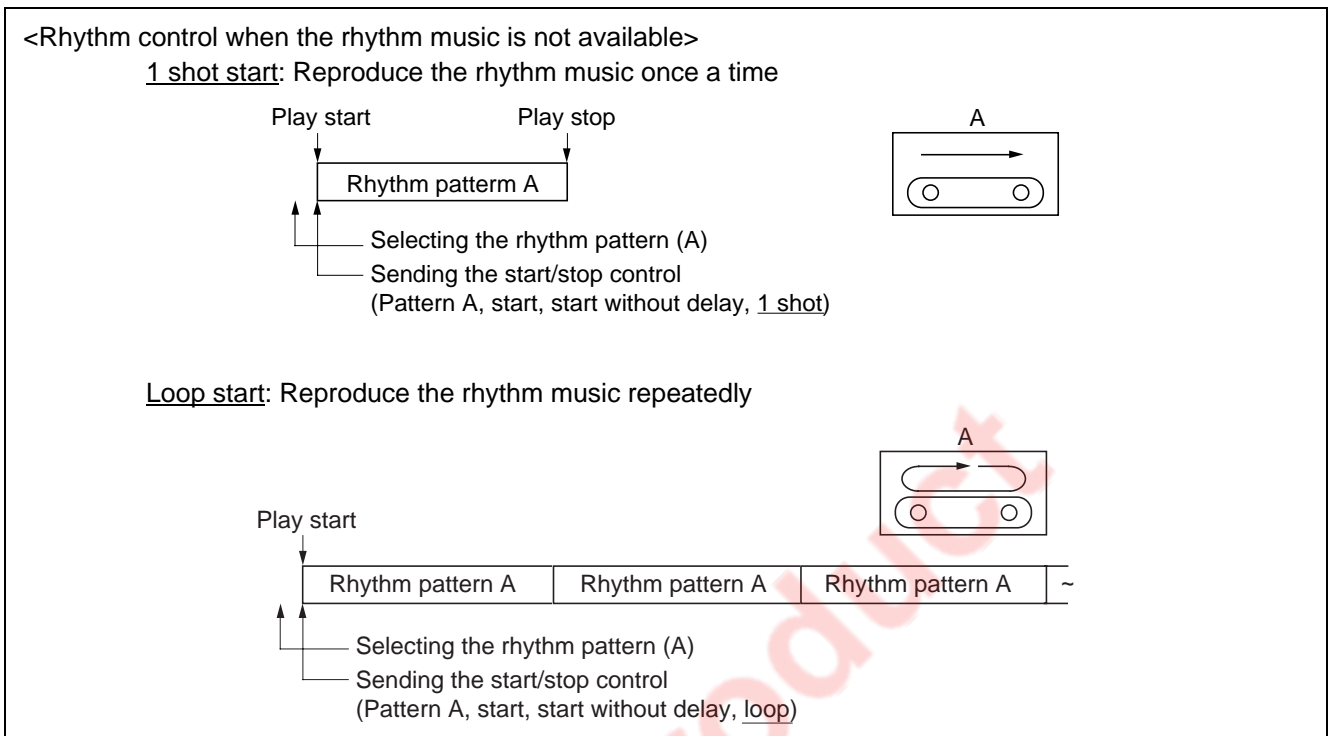

- Notes:
1. Please send the control mode before the end of rhythm pattern A
 2. If you resend the start/stop command before the start of rhythm pattern B, executed the newest control command.
 3. Please preset the rhythm pattern select (B) like that, or preset before sending the rhythm pattern B control command.

Chain start (1 shot→loop): Reproduce the rhythm patterns that connecting one shot and loop rhythm pattern.

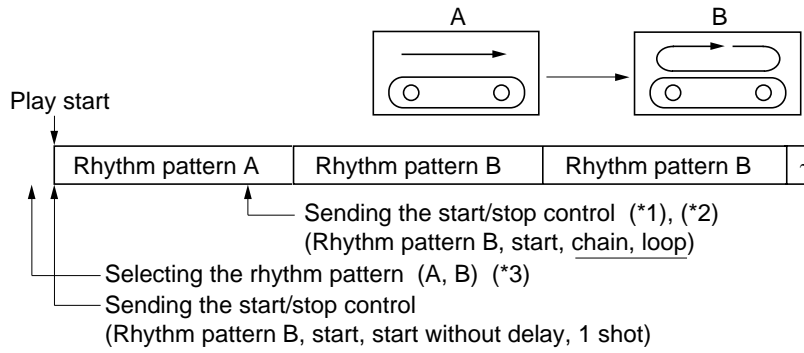

Chain start (loop→1 shot): Reproduce the rhythm patterns that connecting loop and 1 shot rhythm pattern.

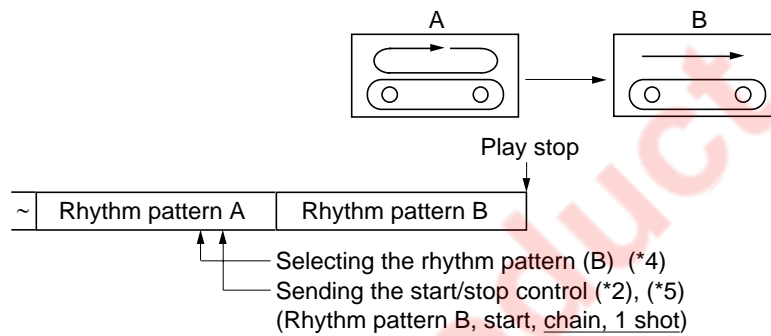

Notes: 4. Please send the rhythm pattern B command before sending the start/stop control pattern B (Can be set the preset)

5. After end of the rhythm pattern A music, please start the play of rhythm pattern B.

Chain start (loop→loop): Reproduce the rhythm patterns that connecting loop and another loop rhythm pattern.

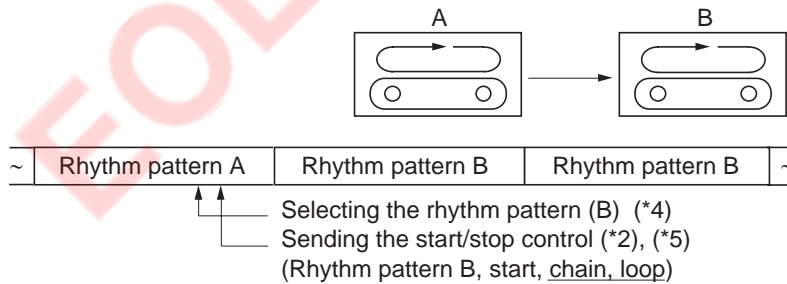

Start without delay: Stopping the rhythm music play without delay, and starting another rhythm music without delay

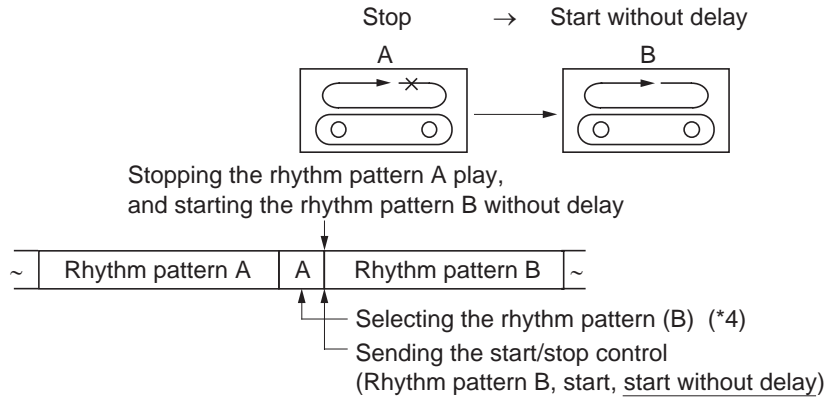

Stop without delay: Stopping the rhythm music without delay

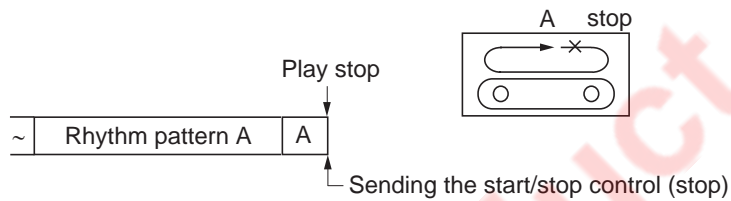

(7) PAD control

() at the first setting mode

Command	Byte No.	Bit Allotment							
		D7	D6	D5	D4	D3	D2	D1	D0
PAD control	1	H	H	L	don't care			pad2o (L)	pad1o (L)
	2	pad_sel2 [3:0] (LLLL)				pad_sel1 [3:0] (LLLL)			

Notes: PAD control command can set the 2 units (PAD1 and PAD2) control.

pad1o: Control command of PAD1

H: Output the PAD1 music source, L: Don't care

pad2o: Control command of PAD2

H: Output the PAD2 music source, L: Don't care

pad_sel [3:0]: Select the PAD1, 2 music sources

Following is the contents of music source select.

Music source details are under consideration

pad_sel1 [3:0]				PAD1
[3]	[2]	[1]	[0]	
L	L	L	L	music source 0
L	L	L	H	music source 1
L	L	H	L	music source 2
L	L	H	H	music source 3
L	H	L	L	music source 4
L	H	L	H	music source 5
L	H	H	L	music source 6
L	H	H	H	music source 7
H	L	L	L	music source 8
H	L	L	H	music source 9
H	L	H	L	music source 10
H	L	H	H	music source 11
H	H	L	L	music source 12
H	H	L	H	music source 13
H	H	H	L	music source 14
H	H	H	H	music source 15

pad_sel2 [3:0]				PAD2
[3]	[2]	[1]	[0]	
L	L	L	L	music source 0
L	L	L	H	music source 1
L	L	H	L	music source 2
L	L	H	H	music source 3
L	H	L	L	music source 4
L	H	L	H	music source 5
L	H	H	L	music source 6
L	H	H	H	music source 7
H	L	L	L	music source 8
H	L	L	H	music source 9
H	L	H	L	music source 10
H	L	H	H	music source 11
H	H	L	L	music source 12
H	H	L	H	music source 13
H	H	H	L	music source 14
H	H	H	H	music source 15

(8) Reset/Test

() at the first setting mode

Command	Byte No.	Bit allotment							
		D7	D6	D5	D4	D3	D2	D1	D0
Reset/Test	1	H	H	H	sreset (L)	test [3:0] (LLLL)			

Note: reset: Setting the software reset control.

H: system reset mode (L: not use)

test [3:0]: This setting use only shipment test.

Normal mode setting is "LLLL" *Please don't use another setting

(9) Summary of command bits

() at the first setting mode

Command	Byte No.	Bit Allotment							
		D7	D6	D5	D4	D3	D2	D1	D0
Tempo	1	L	L	L	don't care				
	2	tempo [7:0] (LHLLHLL)							
Rhythm pattern select A	1	L	L	H	don't care				
	2	don't care			rhythm_pat_sel_a [5:0] (LLLLLL)				
Rhythm pattern select B	1	L	H	L	don't care				
	2	don't care			rhythm_pat_sel_b [5:0] (LLLLLL)				
Rhythm pattern select C	1	L	H	H	don't care				
	2	don't care			rhythm_pat_sel_c [5:0] (LLLLLL)				
Gain/Attenuate level	1	H	L	L	don't care	att [3:0] (LLLL)			
Start/stop control	1	H	L	H	pat_sel [1:0] (LL)		start (L)	s_mode (L)	e_mode (L)
PAD control	1	H	H	L	don't care			pad1o (L)	pad2o (L)
	2	pad_sel2 [3:0] (LLLL)				pad_sel1 [3:0] (LLLL)			
Reset/Test	1	H	H	H	sreset (L)	test [3:0] (LLLL)			

Package Dimensions

JEITA Package Code	RENESAS Code	Previous Code	MASS[Typ.]
P-SSOP36-8.4x15-0.80	PRSP0036GA-A	36P2R-A	0.5g

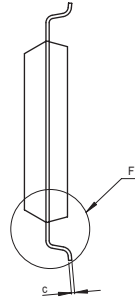
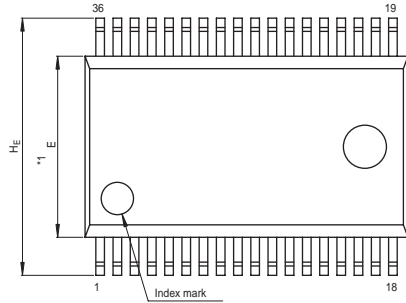

NOTE)
 1. DIMENSIONS **1* AND **2* DO NOT INCLUDE MOLD FLASH.
 2. DIMENSION **3* DOES NOT INCLUDE TRIM OFFSET.

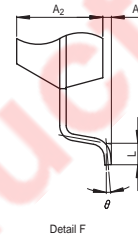
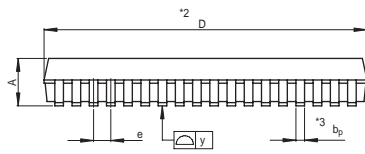

Reference Symbol	Dimension in Millimeters		
	Min	Nom	Max
D	14.8	15.0	15.2
E	8.2	8.4	8.6
A ₂	—	2.0	—
A	—	—	2.4
A ₁	0.05	—	—
b _p	0.35	0.4	0.5
c	0.13	0.15	0.2
θ	0°	—	10°
H _E	11.63	11.93	12.23
e	0.65	0.8	0.95
y	—	—	0.15
L	0.3	0.5	0.7

EOL Product

Notes:

1. This document is provided for reference purposes only so that Renesas customers may select the appropriate Renesas products for their use. Renesas neither makes warranties or representations with respect to the accuracy or completeness of the information contained in this document nor grants any license to any intellectual property rights or any other rights of Renesas or any third party with respect to the information in this document.
2. Renesas shall have no liability for damages or infringement of any intellectual property or other rights arising out of the use of any information in this document, including, but not limited to, product data, diagrams, charts, programs, algorithms, and application circuit examples.
3. You should not use the products or the technology described in this document for the purpose of military applications such as the development of weapons of mass destruction or for the purpose of any other military use. When exporting the products or technology described herein, you should follow the applicable export control laws and regulations, and procedures required by such laws and regulations.
4. All information included in this document such as product data, diagrams, charts, programs, algorithms, and application circuit examples, is current as of the date this document is issued. Such information, however, is subject to change without any prior notice. Before purchasing or using any Renesas products listed in this document, please confirm the latest product information with a Renesas sales office. Also, please pay regular and careful attention to additional and different information to be disclosed by Renesas such as that disclosed through our website. (<http://www.renesas.com>)
5. Renesas has used reasonable care in compiling the information included in this document, but Renesas assumes no liability whatsoever for any damages incurred as a result of errors or omissions in the information included in this document.
6. When using or otherwise relying on the information in this document, you should evaluate the information in light of the total system before deciding about the applicability of such information to the intended application. Renesas makes no representations, warranties or guarantees regarding the suitability of its products for any particular application and specifically disclaims any liability arising out of the application and use of the information in this document or Renesas products.
7. With the exception of products specified by Renesas as suitable for automobile applications, Renesas products are not designed, manufactured or tested for applications or otherwise in systems the failure or malfunction of which may cause a direct threat to human life or create a risk of human injury or which require especially high quality and reliability such as safety systems, or equipment or systems for transportation and traffic, healthcare, combustion control, aerospace and aeronautics, nuclear power, or undersea communication transmission. If you are considering the use of our products for such purposes, please contact a Renesas sales office beforehand. Renesas shall have no liability for damages arising out of the uses set forth above.
8. Notwithstanding the preceding paragraph, you should not use Renesas products for the purposes listed below:
 - (1) artificial life support devices or systems
 - (2) surgical implantations
 - (3) healthcare intervention (e.g., excision, administration of medication, etc.)
 - (4) any other purposes that pose a direct threat to human lifeRenesas shall have no liability for damages arising out of the uses set forth in the above and purchasers who elect to use Renesas products in any of the foregoing applications shall indemnify and hold harmless Renesas Technology Corp., its affiliated companies and their officers, directors, and employees against any and all damages arising out of such applications.
9. You should use the products described herein within the range specified by Renesas, especially with respect to the maximum rating, operating supply voltage range, movement power voltage range, heat radiation characteristics, installation and other product characteristics. Renesas shall have no liability for malfunctions or damages arising out of the use of Renesas products beyond such specified ranges.
10. Although Renesas endeavors to improve the quality and reliability of its products, IC products have specific characteristics such as the occurrence of failure at a certain rate and malfunctions under certain use conditions. Please be sure to implement safety measures to guard against the possibility of physical injury, and injury or damage caused by fire in the event of the failure of a Renesas product, such as safety design for hardware and software including but not limited to redundancy, fire control and malfunction prevention, appropriate treatment for aging degradation or any other applicable measures. Among others, since the evaluation of microcomputer software alone is very difficult, please evaluate the safety of the final products or system manufactured by you.
11. In case Renesas products listed in this document are detached from the products to which the Renesas products are attached or affixed, the risk of accident such as swallowing by infants and small children is very high. You should implement safety measures so that Renesas products may not be easily detached from your products. Renesas shall have no liability for damages arising out of such detachment.
12. This document may not be reproduced or duplicated, in any form, in whole or in part, without prior written approval from Renesas.
13. Please contact a Renesas sales office if you have any questions regarding the information contained in this document, Renesas semiconductor products, or if you have any other inquiries.



RENESAS SALES OFFICES

<http://www.renesas.com>

Refer to "<http://www.renesas.com/en/network>" for the latest and detailed information.

Renesas Technology America, Inc.
450 Holger Way, San Jose, CA 95134-1368, U.S.A
Tel: <1> (408) 382-7500, Fax: <1> (408) 382-7501

Renesas Technology Europe Limited
Dukes Meadow, Millboard Road, Bourne End, Buckinghamshire, SL8 5FH, U.K.
Tel: <44> (1628) 585-100, Fax: <44> (1628) 585-900

Renesas Technology (Shanghai) Co., Ltd.
Unit 204, 205, AZIACenter, No.1233 Lujiazui Ring Rd, Pudong District, Shanghai, China 200120
Tel: <86> (21) 5877-1818, Fax: <86> (21) 6887-7858/7898

Renesas Technology Hong Kong Ltd.
7th Floor, North Tower, World Finance Centre, Harbour City, Canton Road, Tsimshatsui, Kowloon, Hong Kong
Tel: <852> 2265-6688, Fax: <852> 2377-3473

Renesas Technology Taiwan Co., Ltd.
10th Floor, No.99, Fushing North Road, Taipei, Taiwan
Tel: <886> (2) 2715-2888, Fax: <886> (2) 3518-3399

Renesas Technology Singapore Pte. Ltd.
1 Harbour Front Avenue, #06-10, Keppel Bay Tower, Singapore 098632
Tel: <65> 6213-0200, Fax: <65> 6278-8001

Renesas Technology Korea Co., Ltd.
Kukje Center Bldg. 18th Fl., 191, 2-ka, Hangang-ro, Yongsan-ku, Seoul 140-702, Korea
Tel: <82> (2) 796-3115, Fax: <82> (2) 796-2145

Renesas Technology Malaysia Sdn. Bhd
Unit 906, Block B, Menara Amcorp, Amcorp Trade Centre, No.18, Jln Persiaran Barat, 46050 Petaling Jaya, Selangor Darul Ehsan, Malaysia
Tel: <603> 7955-9390, Fax: <603> 7955-9510