

Surface Mount General Purpose Rectifier

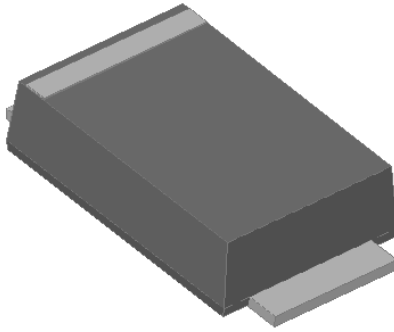

Features

- Low profile package
- Ideal for automated placement
- Glass passivated chip junction
- High forward surge capability
- Meets MSL level 1, per J-STD-020, LF maximum peak of 260 °C

Typical Applications

For use in general purpose rectification of power supplies, inverters, converters, and freewheeling diodes for consumer, automotive, and telecommunication.

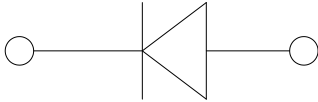

Mechanical Data

- **Package:** SMAF
Molding compound meets UL 94 V-0 flammability rating, RoHS-compliant, halogen-free
- **Terminals:** Tin plated leads, solderable per J-STD-002 and JESD22-B102
- **Polarity:** Cathode line denotes the cathode end

■ Maximum Ratings ($T_a=25^\circ\text{C}$ Unless otherwise specified)

PARAMETER	SYMBOL	UNIT	M1F	M2F	M3F	M4F	M5F	M6F	M7F
Device marking code			M1F	M2F	M3F	M4F	M5F	M6F	M7F
Repetitive peak reverse voltage	VRRM	V	50	100	200	400	600	800	1000
Average rectified output current @60Hz sine wave, resistance load, T_L (Fig.1)	I_O	A	1.0						
Surge(non-repetitive)forward current @ 60Hz half-sine wave, 1 cycle, $T_a=25^\circ\text{C}$	IFSM	A	30						
Storage temperature	T_{stg}	$^\circ\text{C}$	-55~+150						
Junction temperature	T_j	$^\circ\text{C}$	-55~+150						

■ Electrical Characteristics ($T_a=25^\circ\text{C}$ Unless otherwise specified)

PARAMETER	SYMBOL	UNIT	TEST CONDITIONS	M1F	M2F	M3F	M4F	M5F	M6F	M7F
Maximum instantaneous forward voltage drop per diode	V_F	V	IFM=1.0A	1.1						
Maximum DC reverse current at rated DC blocking voltage per diode @ VRM=VRRM	IRRM	μA	$T_a=25^\circ\text{C}$	5.0						
			$T_a=125^\circ\text{C}$	100						

■ Thermal Characteristics ($T_a=25^\circ\text{C}$ Unless otherwise specified)

PARAMETER	SYMBOL	UNIT	M1F	M2F	M3F	M4F	M5F	M6F	M7F
Thermal resistance	$R_{\theta J-L(1)}$	$^\circ\text{C/W}$	20 ¹⁾						



M1F THRU M7F

Ordering Information (Example)

PREFERRED P/N	PACKING CODE	UNIT WEIGHT(g)	MINIMUM PACKAGE(pcs)	INNER BOX QUANTITY(pcs)	OUTER CARTON QUANTITY(pcs)	DELIVERY MODE
M1F-M7F	F1	Approximate 0.034	3000	12000	96000	7" reel
M1F-M7F	F2	Approximate 0.034	7500	15000	120000	13" reel

Characteristics (Typical)

FIG1: Io-TL Curve

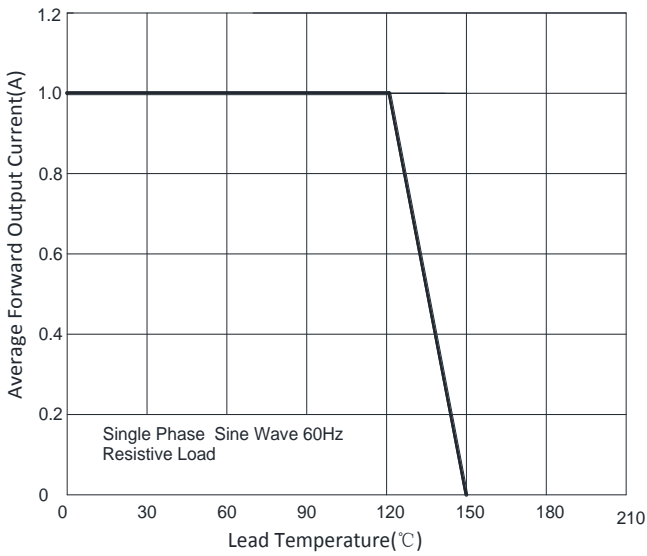

FIG2: Surge Forward Current Capability

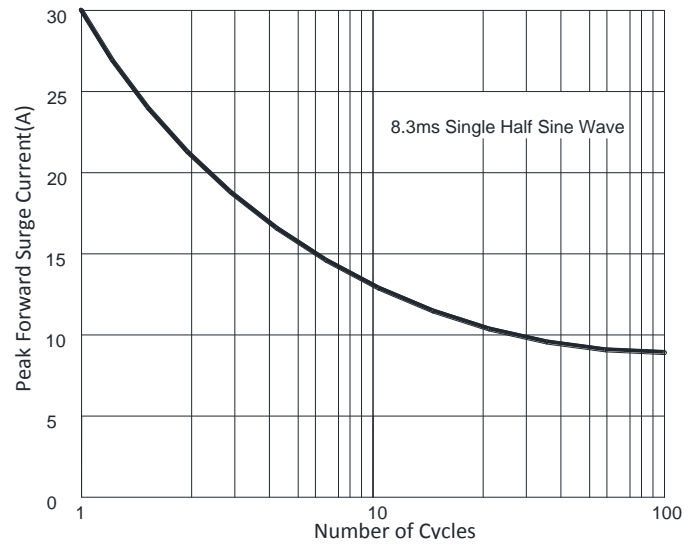

FIG3: Forward Voltage

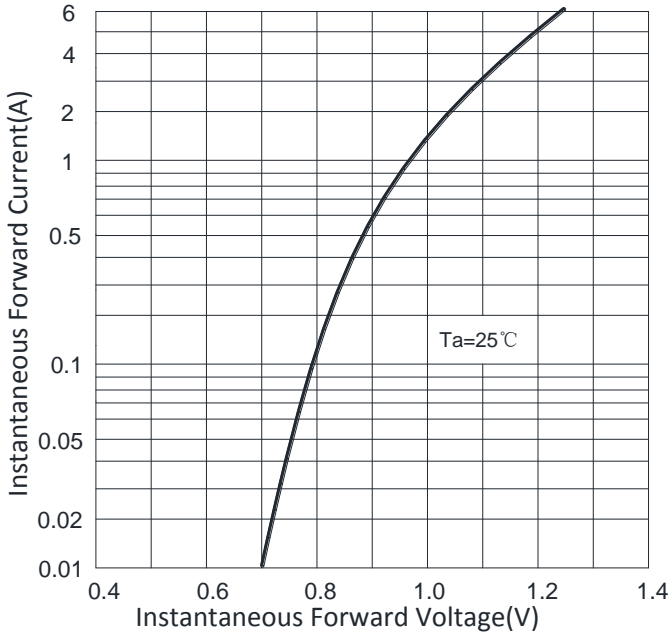

FIG4: Typical Reverse Characteristics

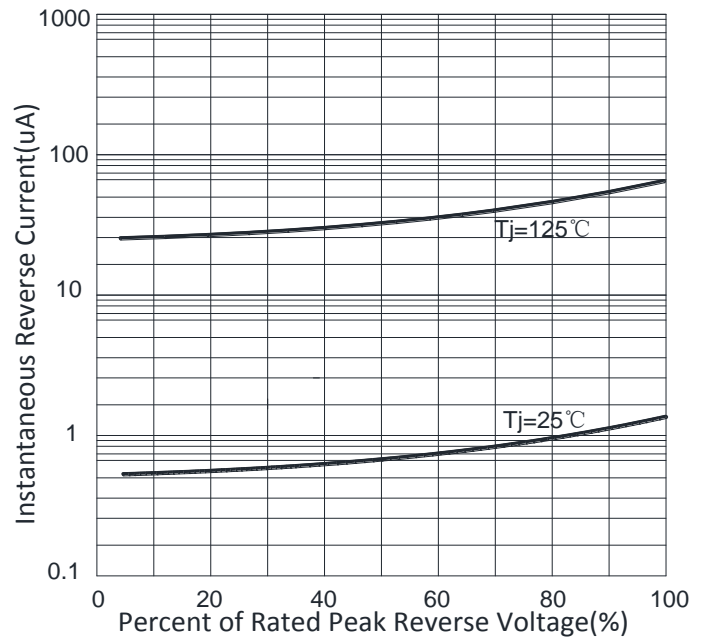
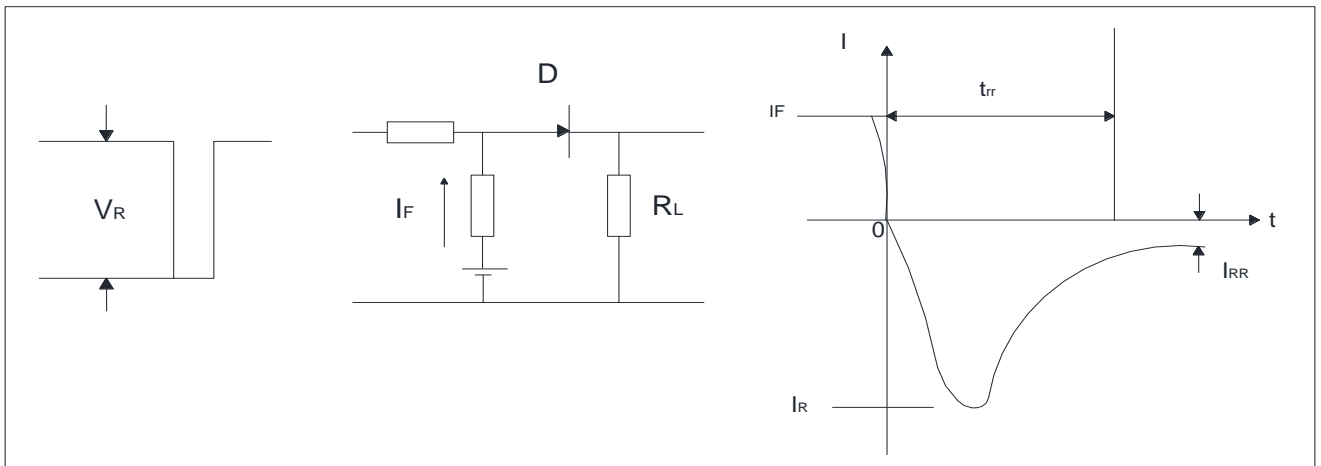
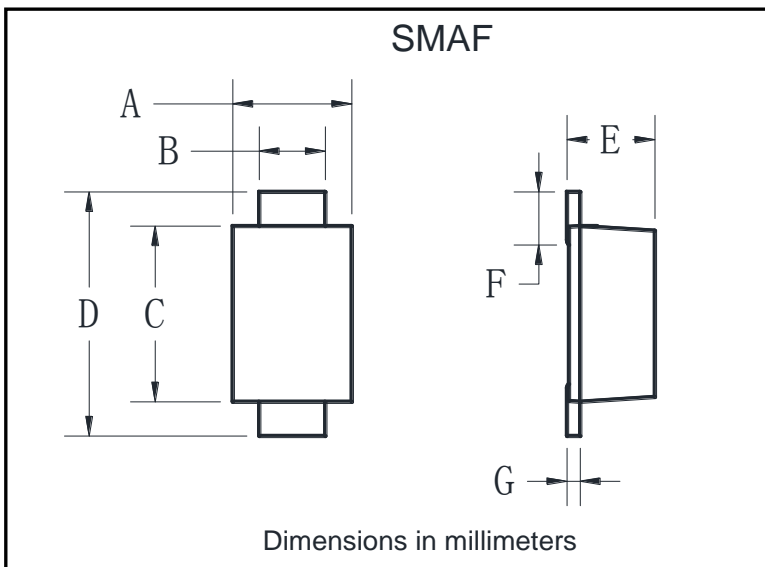

FIG.5: Diagram of circuit and Testing wave form of reverse recovery time



■ Outline Dimensions



SMAF		
Dim	Min	Max
A	2.40	2.80
B	1.35	1.45
C	3.40	3.60
D	4.40	4.80
E	1.05	1.25
F	0.50	1.00
G	0.15	0.22

■ Suggested pad layout

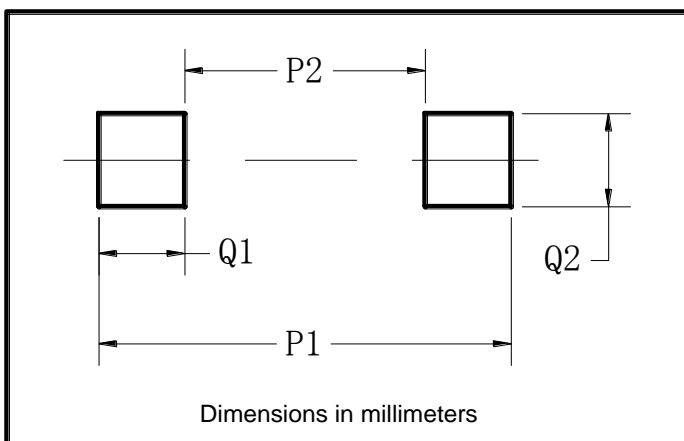

Dim	Min
P1	5.90
P2	2.70
Q1	1.60
Q2	1.90



M1F THRU M7F

Disclaimer

The information presented in this document is for reference only. Yangzhou Yangjie Electronic Technology Co., Ltd. reserves the right to make changes without notice for the specification of the products displayed herein to improve reliability, function or design or otherwise.

The product listed herein is designed to be used with ordinary electronic equipment or devices, and not designed to be used with equipment or devices which require high level of reliability and the malfunction of which would directly endanger human life (such as medical instruments, transportation equipment, aerospace machinery, nuclear-reactor controllers, fuel controllers and other safety devices), Yangjie or anyone on its behalf, assumes no responsibility or liability for any damages resulting from such improper use of sale.

This publication supersedes & replaces all information previously supplied. For additional information, please visit our website [http:// www.21yangjie.com](http://www.21yangjie.com) , or consult your nearest Yangjie's sales office for further assistance.