

PRELIMINARY
 Notice: This is not a final specification.
 Some parametric limits are subject to change.

M81719FP

HIGH VOLTAGE HALF BRIDGE DRIVER

DESCRIPTION

M81719FP is high voltage Power MOSFET and IGBT module driver for half bridge applications.

FEATURES

- FLOATING SUPPLY VOLTAGE 600V
- OUTPUT CURRENT +120mA/-250mA
- HALF BRIDGE DRIVER
- UNDERVOLTAGE LOCKOUT
- SOP-8 PACKAGE

APPLICATIONS

MOSFET and IGBT module inverter driver for Automotive, PDP, HID lamp, refrigerator, air-conditioner, washing machine, AC-servomotor and general purpose.

PIN CONFIGURATION (TOP VIEW)

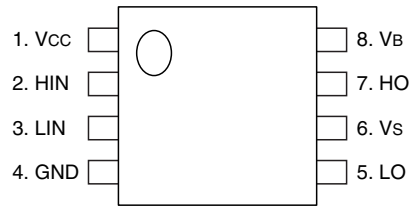

Outline:8P2S

BLOCK DIAGRAM

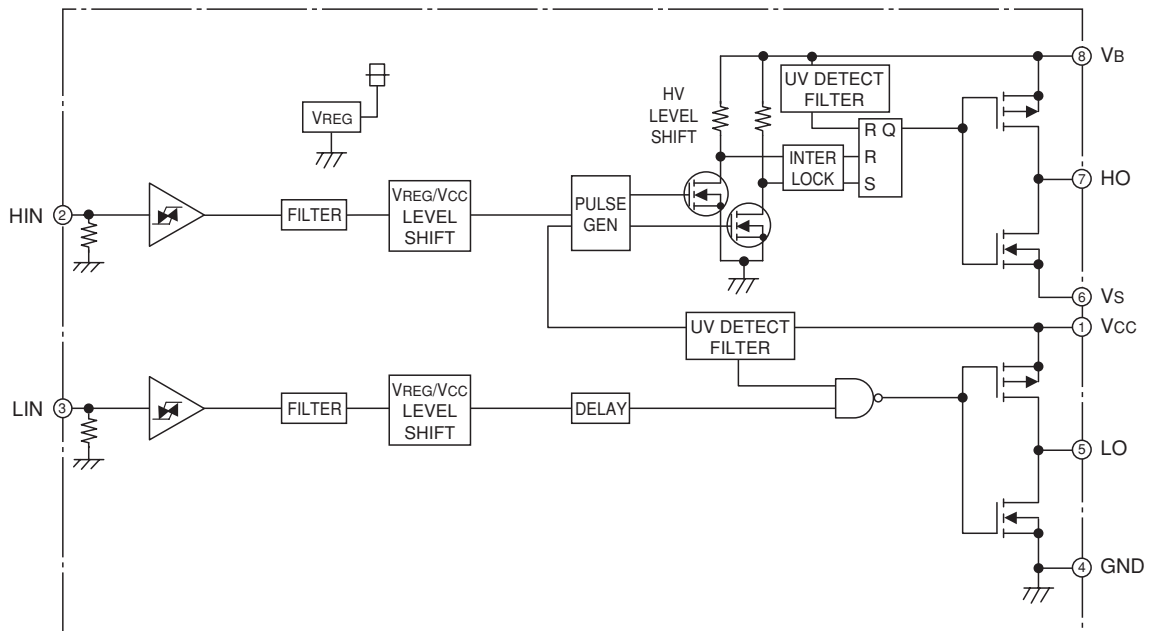

PRELIMINARY
 Notice: This is not a final specification.
 Some parametric limits are subject to change.

ABSOLUTE MAXIMUM RATINGS (Ta = 25°C unless otherwise specified)

Symbol	Parameter	Test conditions	Ratings	Unit
V _B	High Side Floating Supply Absolute Voltage		-0.5 ~ 624	V
V _S	High Side Floating Supply Offset Voltage		V _B -24 ~ V _B +0.5	V
V _{BS}	High Side Floating Supply Voltage	V _{BS} = V _B -V _S	-0.5 ~ 24	V
V _{HO}	High Side Output Voltage		V _S -0.5 ~ V _B +0.5	V
V _{CC}	Low Side Fixed Supply Voltage		-0.5 ~ 24	V
V _{LO}	Low Side Output Voltage		-0.5 ~ V _{CC} +0.5	V
V _{IN}	Logic Input Voltage	HIN, LIN	-0.5 ~ V _{CC} +0.5	V
P _d	Package Power Dissipation	Ta = 25°C, On Board	0.6	W
K _θ	Linear Derating Factor	Ta > 25°C, On Board	6.0	mW/°C
R _{th(j-c)}	Junction-Case Thermal Resistance		50	°C/W
T _j	Junction Temperature		-20 ~ 125	°C
T _{opr}	Operation Temperature		-20 ~ 100	°C
T _{stg}	Storage Temperature		-40 ~ 125	°C

RECOMMENDED OPERATING CONDITIONS

Symbol	Parameter	Test conditions	Limits			Unit
			Min.	Typ.	Max.	
V _B	High Side Floating Supply Absolute Voltage		V _S +10	—	V _S +20	V
V _S	High Side Floating Supply Offset Voltage		0	—	500	V
V _{BS}	High Side Floating Supply Voltage	V _{BS} = V _B -V _S	10	—	20	V
V _{HO}	High Side Output Voltage		V _S	—	V _B	V
V _{CC}	Low Side Fixed Supply Voltage		10	—	20	V
V _{LO}	Low Side Output Voltage		0	—	V _{CC}	V
V _{IN}	Logic Input Voltage	HIN, LIN	0	—	7	V

* For proper operation, the device should be used within the recommended conditions.

THERMAL DERATING FACTOR CHARACTERISTIC (MAXIMUM RATING)

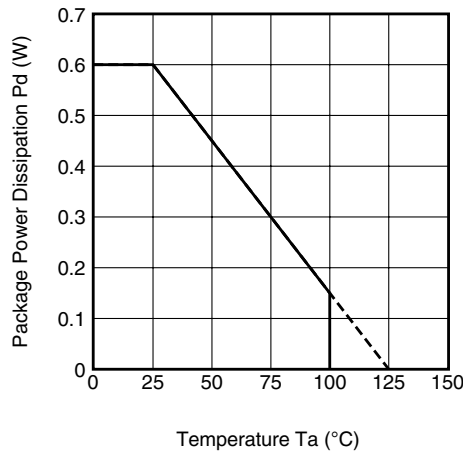

PRELIMINARY
 Notice: This is not a final specification.
 Some parametric limits are subject to change.

HIGH VOLTAGE HALF BRIDGE DRIVER

ELECTRICAL CHARACTERISTICS (Ta = 25°C, Vcc = Vbs (= Vb-Vs) = 15V, unless otherwise specified)

Symbol	Parameter	Test conditions	Limits			Unit
			Min.	Typ.*	Max.	
IFS	Floating Supply Leakage Current	Vb = Vs = 600V	—	—	1.0	μA
IBS	Vbs Standby Current	HIN = LIN = 0V	—	0.2	0.5	mA
ICC	Vcc Standby Current	HIN = LIN = 0V	0.2	0.6	1.0	mA
VOH	High Level Output Voltage	Io = -20mA, LO, HO	13.6	14.2	—	V
VOL	Low Level Output Voltage	Io = 20mA, LO, HO	—	0.3	0.6	V
VIH	High Level Input Threshold Voltage	HIN, LIN	2.7	—	—	V
VIL	Low Level Input Threshold Voltage	HIN, LIN	—	—	0.8	V
IiH	High Level Input Bias Current	VIN = 5V	—	5	20	μA
IiL	Low Level Input Bias Current	VIN = 0V	—	—	2	μA
VBSuvr	Vbs Supply UV Reset Voltage		8.0	8.9	9.8	V
VBSuvt	Vbs Supply UV Trip Voltage		7.4	8.2	9.0	V
VBSuvh	Vbs Supply UV Hysteresis Voltage		0.4	0.6	—	V
tVBSuv	Vbs Supply UV Filter Time		—	7.5	—	μs
VCCuvr	Vcc Supply UV Reset Voltage		8.0	8.9	9.8	V
VCCuvt	Vcc Supply UV Trip Voltage		7.4	8.2	9.0	V
VCCuvh	Vcc Supply UV Hysteresis Voltage		0.4	0.6	—	V
tVCCuv	Vcc Supply UV Filter Time		—	7.5	—	μs
IOH	Output High Level Short Circuit Pulsed Current	Vo = 0V, VIN = 5V, PW < 10μs**	120	200	—	mA
IOL	Output Low Level Short Circuit Pulsed Current	Vo = 15V, VIN = 0V, PW < 10μs**	250	350	—	mA
ROH	Output High Level On Resistance	Io = -20mA, ROH = (VOH-Vo)/Io	—	40	70	Ω
ROL	Output Low Level On Resistance	Io = 20mA, ROL = Vo/Io	—	15	30	Ω
tdLH(HO)	High Side Turn-On Propagation Delay	CL = 1000pF between HO-Vs	—	250	350	ns
tdHL(HO)	High Side Turn-Off Propagation Delay	CL = 1000pF between HO-Vs	—	250	350	ns
trH	High Side Turn-On Rise Time	CL = 1000pF between HO-Vs	—	130	220	ns
tfH	High Side Turn-Off Fall Time	CL = 1000pF between HO-Vs	—	50	80	ns
tdLH(LO)	Low Side Turn-On Propagation Delay	CL = 1000pF between LO-GND	—	250	350	ns
tdHL(LO)	Low Side Turn-Off Propagation Delay	CL = 1000pF between LO-GND	—	250	350	ns
trL	Low Side Turn-On Rise Time	CL = 1000pF between LO-GND	—	130	220	ns
tfL	Low Side Turn-Off Fall Time	CL = 1000pF between LO-GND	—	50	80	ns
ΔtdLH	Delay Matching, High Side and Low Side Turn-On	tdLH(HO)-tdLH(LO)	—	0	30	ns
ΔtdHL	Delay Matching, High Side and Low Side Turn-Off	tdHL(HO)-tdHL(LO)	—	0	30	ns
tinon	Input Filter Time (ON)	CONVEX PULSE	60	80	100	ns
		CONCAVE PULSE	110	150	190	ns
tinoff	Input Filter Time (OFF)	CONVEX PULSE	60	80	100	ns
		CONCAVE PULSE	110	150	190	ns
ΔPWIO	I/O Pulse Width Difference	PW(IN)-PW(OUT)	—	—	100	ns

* Typ. is not specified.

** It is recommended not to input short pulse continuously.

PRELIMINARY
 Notice: This is not a final specification.
 Some parametric limits are subject to change.

TIMING REQUIREMENT

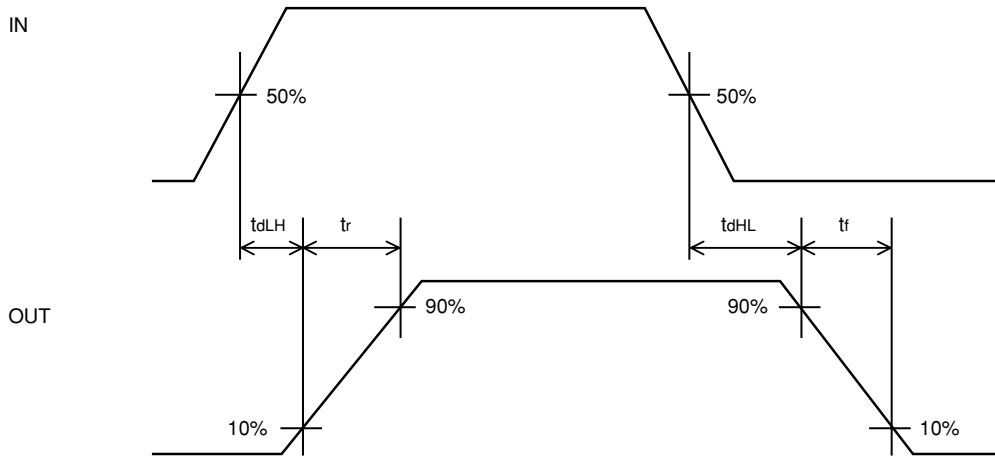

FUNCTION TABLE (X: H or L)

HIN	LIN	V _{BS} UV	V _{CC} UV	HO	LO	Behavioral state
L	L	H	H	L	L	LO = HO = Low
L	H	H	H	L	H	LO = High
H	L	H	H	H	L	HO = High
H	H	H	H	H	H	LO = HO = High
X	L	L	H	L	L	HO = Low, V _{BS} UV tripped
X	H	L	H	L	H	LO = High, V _{BS} UV tripped
L	X	H	L	L	L	LO = Low, V _{CC} UV tripped
H	X	H	L	L	L	HO = LO = Low, V _{CC} UV tripped

Note : "L" state of V_{BS} UV, V_{CC} UV means that UV trip voltage.

TIMING DIAGRAM

1. Input/Output Timing Diagram

HIGH ACTIVE (When input signal (HIN or LIN) is "H", then output signal (HO or LO) is "H".)

Because there is not interlock circuit, in the case of both input signals (HIN and LIN) are "H", output signals (HO and LO) become "H".

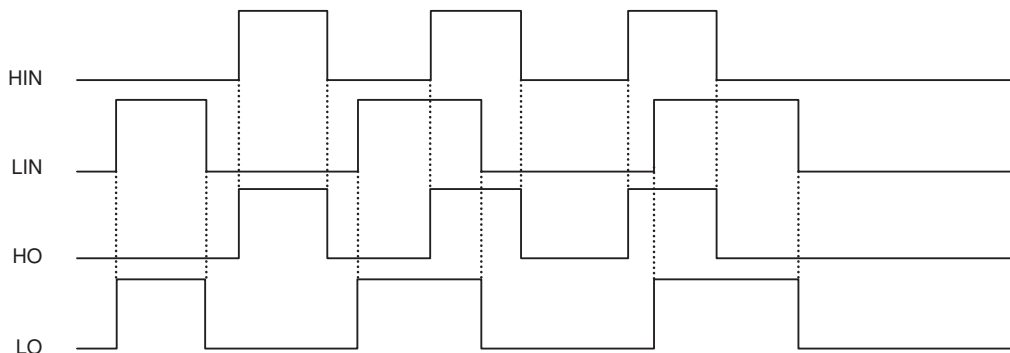

PRELIMINARY
 Notice: This is not a final specification.
 Some parametric limits are subject to change.

2.Vcc (Vbs) Supply Under Voltage Lockout Timing Diagram

When Vcc Supply Voltage keeps lower UV Trip Voltage ($V_{CC\text{uvt}} = V_{CC\text{uvr}} - V_{CC\text{uvh}}$) for Vcc Supply UV Filter Time, output signal becomes "L". And then, when Vcc Supply Voltage is higher than UV Reset Voltage, output signal LO becomes "H".

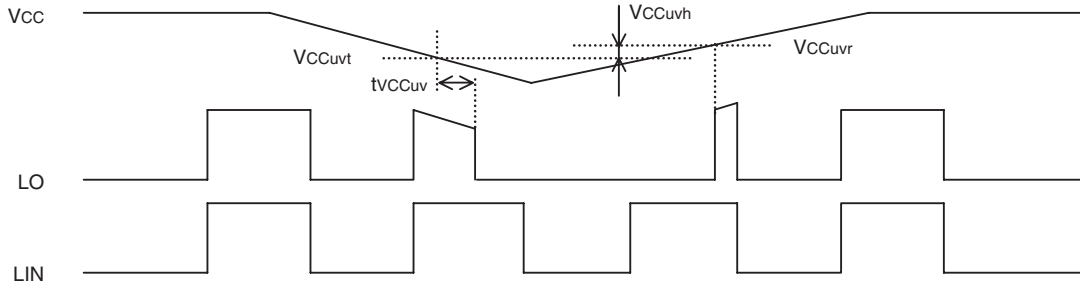

When Vcc Supply Voltage keeps lower UV Trip Voltage ($V_{CC\text{uvt}} = V_{CC\text{uvr}} - V_{CC\text{uvh}}$) for Vcc Supply UV Filter Time, output signal becomes "L". And then, when Vcc Supply Voltage is higher than UV Reset Voltage, input signal (LIN) is L; output signal HO becomes "H".

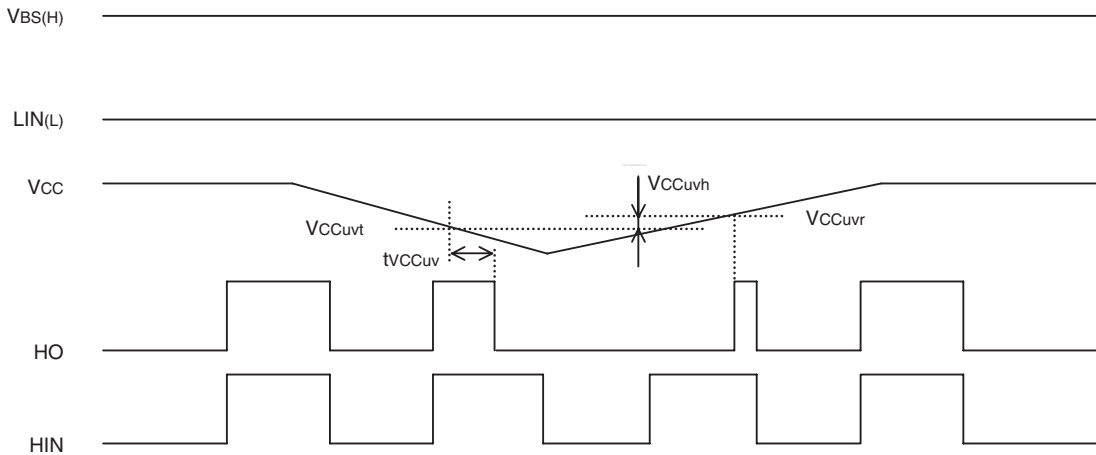

When Vbs Supply Voltage keeps lower UV Trip Voltage ($V_{BS\text{uvt}} = V_{BS\text{uvr}} - V_{BS\text{uvh}}$) for Vbs Supply UV Filter Time, output signal becomes "L". And then, Vbs Supply Voltage is higher than UV Reset Voltage, output signal HO keeps "L" until next input signal HIN is "H".

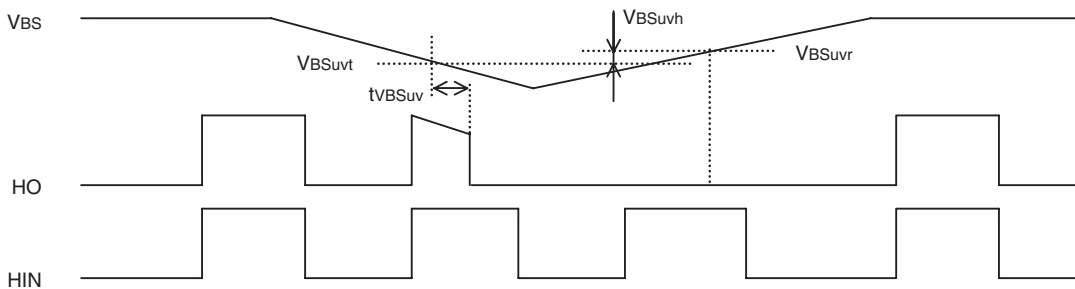

PRELIMINARY
 Notice: This is not a final specification.
 Some parametric limits are subject to change.

3. Allowable Supply Voltage Transient

It is recommended that supplying VCC firstly and supplying VBS secondly. In the case of shutting off supply voltage, shutting off VBS firstly and shutting off VCC secondly. At the time of starting VCC and VBS, power supply should be increased slowly. If it is increased rapidly, output signal (HO or LO) may be "H".

Consideration

As for this product, the terminal of low voltage part and high-voltage part is very clear (The Fifth: LO, The Sixth: Vs). Therefore, pin insulation space distance should be taken enough.

PACKAGE OUTLINE

