



# M8257 PROGRAMMABLE DMA CONTROLLER

*Military*

- Military Temperature Range:**  
-55°C to +125°C (T<sub>CASE</sub>)
- Terminal Count and Modulo 128 Outputs**
- 4-Channel DMA Controller**
- Single TTL Clock**
- Priority DMA Request Logic**
- Single +5V Supply**
- Channel Inhibit Logic**
- Auto Load Mode**

The Intel M8257 is a 4-channel direct memory access (DMA) controller. It is specifically designed to simplify the transfer of data at high speeds for the Intel microcomputer systems. Its primary function is to generate, upon a peripheral request, a sequential memory address which will allow the peripheral to read or write data directly to or from memory. Acquisition of the system bus is accomplished via the CPU's hold function. The M8257 has priority logic that resolves the peripherals requests and issues a composite hold request to the CPU. It maintains the DMA cycle count for each channel and outputs a control signal to notify the peripheral that the programmed number of DMA cycles is complete. Other output control signals simplify sectorized data transfers. The M8257 represents a significant savings in component count for DMA-based microcomputer systems and greatly simplifies the transfer of data at high speed between peripherals and memories.

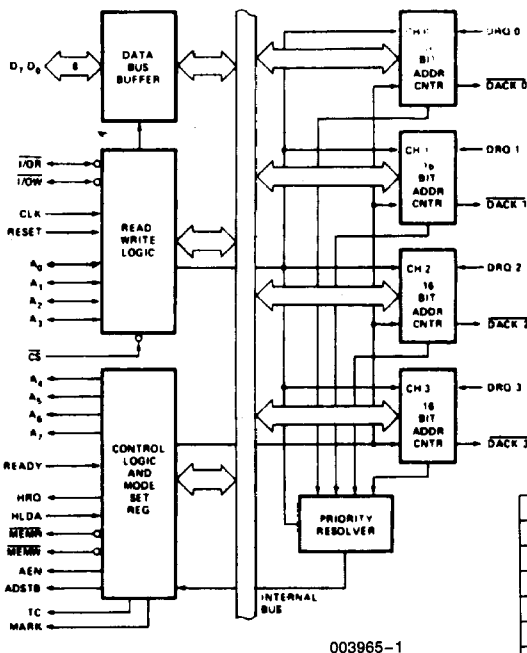
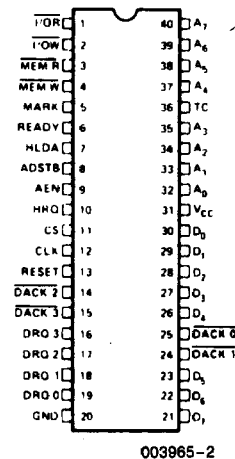

Figure 1. Block Diagram



D7-D0	Data Bus
A7-A0	Address Bus
I/O	I/O Read
I/O	I/O Write
MEMR	Memory Read
MEMW	Memory Write
CLK	Clock Input
RESET	Reset Input
READY	Ready
HRQ	Hold Request (To M8080A)
HLDA	Hold Acknowledge (From M8080A)

AEN	Address Enable
ADSTB	Address Strobe
TC	Terminal Count
MARK	Modulo 128 Mark
DRQ3-DRQ0	DMA Request Input
DACK3-DACK0	DMA Acknowledge Out
CS	Chip Select
VCC	+5 Volts
GND	Ground

Figure 2. Pin Configuration

17

**ABSOLUTE MAXIMUM RATINGS\***

Case Temperature	
Under Bias <sup>(1)</sup> .....	-55°C to +125°C
Storage Temperature .....	-65°C to +150°C
Voltage on Any Pin	
With Respect to Ground .....	-0.5 to +7V
Power Dissipation .....	1.0W

NOTICE: This is a production data sheet. The specifications are subject to change without notice.

*\*WARNING: Stressing the device beyond the "Absolute Maximum Ratings" may cause permanent damage. These are stress ratings only. Operation beyond the "Operating Conditions" is not recommended and extended exposure beyond the "Operating Conditions" may affect device reliability.*

www.datasheet4u.com

**OPERATING CONDITIONS**

Symbol	Parameter	Min	Max	Units
T <sub>C</sub>	Case Temperature (Instant On)	-55	+125	°C
V <sub>CC</sub>	Digital Supply Voltage	4.50	5.50	V

**D.C. CHARACTERISTICS** (Over Specified Operating Conditions)

Symbol	Parameter	Min	Max	Unit	Comments
V <sub>IL</sub>	Input Low Voltage	-0.5	0.8	V	
V <sub>IH</sub>	Input High Voltage	2.2	V <sub>CC</sub> + 0.5	V	
V <sub>OL</sub>	Output Low Voltage		0.45	V	I <sub>OL</sub> = 1.6 mA
V <sub>OH</sub>	Output High Voltage	2.4	V <sub>CC</sub>	V	I <sub>OH</sub> = -150 μA for AB, DB and AEN I <sub>OH</sub> = -80 μA for Others
V <sub>HH</sub>	HRQ Output High Voltage	3.3	V <sub>CC</sub>	V	I <sub>OH</sub> = -80 μA
I <sub>CC</sub>	V <sub>CC</sub> Current Drain		150	mA	
I <sub>IL</sub>	Input Leakage		±10	μA	V <sub>SS</sub> ≤ V <sub>IN</sub> ≤ V <sub>CC</sub>
I <sub>OFL</sub>	Output Leakage During Float		±10	μA	V <sub>SS</sub> + 0.45 ≤ V <sub>OUT</sub> ≤ V <sub>CC</sub>

**CAPACITANCE** T<sub>C</sub> = 25°C, V<sub>CC</sub> = GND = 0V

Symbol	Parameter	Min	Typ	Max	Unit	Comments
C <sub>IN</sub>	Input Capacitance			10	pF	f <sub>c</sub> = 1 MHz
C <sub>I/O</sub>	I/O Capacitance			20	pF	Unmeasured Pins Returned to GND

**A.C. CHARACTERISTICS—DMA (MASTER) MODE**

(Over Specified Operating Conditions)

**TIMING REQUIREMENTS**

Symbol	Parameter	Min	Max	Unit
T <sub>CY</sub>	Cycle Time (Period)	0.320	4	μs
T <sub>θ</sub>	Clock Active (High)	120	0.8 T <sub>CY</sub>	ns
T <sub>QS</sub>	DRQ ↑ Setup to θ ↓ (S1, S4)	120		ns
T <sub>QH</sub>	DRQ ↓ Hold from HLDA ↑ (4)	0		ns
T <sub>HS</sub>	HLDA ↑ or ↓ Setup to θ ↓ (S1, S4)	100		ns
T <sub>RS</sub>	READY Setup Time to θ ↑ (S3, Sw)	30		ns
T <sub>RH</sub>	READY Hold Time from θ ↑ (S3, Sw)	30		ns

**A.C. CHARACTERISTICS—DMA (MASTER) MODE**

(Over Specified Operating Conditions)

**TIMING RESPONSES**

Symbol	Parameter	Min	Max	Unit
$T_{DQ}$	HRQ $\uparrow$ or $\downarrow$ Delay from $\theta \uparrow$ (S1, S4) (Measured at 2.0V) <sup>(1)</sup>		180	ns
$T_{DQ1}$	HRQ $\uparrow$ or $\downarrow$ Delay from $\theta \uparrow$ (S1, S4) (Measured at 3.3V) <sup>(3)</sup>		270	ns
$T_{AEL}$	AEN $\uparrow$ Delay from $\theta \downarrow$ (S1) <sup>(1)</sup>		300	ns
$T_{AET}$	AEN $\downarrow$ Delay from $\theta \uparrow$ (S1) <sup>(1)</sup>		200	ns
$T_{AEA}$	Adr(AB)(Active) Delay from AEN $\uparrow$ (S1) <sup>(4)</sup>	20		ns
$T_{FAAB}$	Adr(AB)(Active) Delay from $\theta \uparrow$ (S1) <sup>(2)</sup>		270	ns
$T_{AFAB}$	Adr(AB)(Float) Delay from $\theta \uparrow$ (S1) <sup>(2)</sup>		200	ns
$T_{ASM}$	Adr(AB)(Stable) Delay from $\theta \uparrow$ (S1) <sup>(2)</sup>		250	ns
$T_{AH}$	Adr(AB)(Stable) Hold from $\theta \uparrow$ (S1) <sup>(2)</sup>	$T_{ASM} - 50$		ns
$T_{AHR}$	Adr(AB)(Valid) Hold from $\overline{Rd} \uparrow$ (S1, S1) <sup>(4)</sup>	60		ns
$T_{AHW}$	Adr(AB)(Valid) Hold from $\overline{Wr} \uparrow$ (S1, S1) <sup>(4)</sup>	300		ns
$T_{FADB}$	Adr(DB)(Active) Delay from $\theta \uparrow$ (S1) <sup>(2)</sup>		300	ns
$T_{AFDB}$	Adr(DB)(Float) Delay from $\theta \uparrow$ (S2) <sup>(2)</sup>	$T_{STT} + 20$	250	ns
$T_{ASS}$	Adr(DB) Setup to AdrStb $\downarrow$ (S1–S2) <sup>(4)</sup>	100		ns
$T_{AHS}$	Adr(DB)(Valid) Hold from AdrStb $\downarrow$ (S2) <sup>(4)</sup>	50		ns
$T_{STL}$	AdrStb $\uparrow$ Delay from $\theta \uparrow$ (S1) <sup>(1)</sup>		200	ns
$T_{STT}$	AdrStb $\downarrow$ Delay from $\theta \uparrow$ (S2) <sup>(1)</sup>		160	ns
$T_{SW}$	AdrStb Width (S1–S2) <sup>(4)</sup>	$T_{CY} - 100$		ns
$T_{ASC}$	$\overline{Rd} \downarrow$ or $\overline{Wr}(\text{Ext}) \downarrow$ Delay from AdrStb $\downarrow$ (S2) <sup>(4)</sup>	70		ns
$T_{DBC}$	$\overline{Rd} \downarrow$ or $\overline{Wr}(\text{Ext}) \downarrow$ Delay from Adr(DB) (Float)(S2) <sup>(4)</sup>	20		ns
$T_{AK}$	DACK $\uparrow$ or $\downarrow$ Delay from $\theta \downarrow$ (S2, S1) and TC/Mark $\uparrow$ Delay from $\theta \uparrow$ (S3) and TC/Mark $\downarrow$ Delay from $\theta \uparrow$ (S4) <sup>(1)(5)</sup>		270	ns
$T_{DCL}$	$\overline{Rd} \downarrow$ or $\overline{Wr}(\text{Ext}) \downarrow$ Delay from $\theta \uparrow$ (S2) and $\overline{Wr} \downarrow$ Delay from $\theta \uparrow$ (S3) <sup>(2)(6)</sup>		250	ns
$T_{DCT}$	$\overline{Rd} \uparrow$ Delay from $\theta \downarrow$ (S1, S1) and $\overline{Wr} \uparrow$ Delay from $\theta \uparrow$ (S4) <sup>(2)(7)</sup>		200	ns
$T_{FAC}$	$\overline{Rd}$ or $\overline{Wr}(\text{Active})$ from $\theta \uparrow$ (S1) <sup>(2)</sup>		300	ns
$T_{AFC}$	$\overline{Rd}$ or $\overline{Wr}(\text{Float})$ from $\theta \uparrow$ (S1) <sup>(2)</sup>		170	ns
$T_{RWM}$	$\overline{Rd}$ Width (S2–S1 or S1) <sup>(4)</sup>	$2T_{CY} + T_{\theta} - 50$		ns
$T_{WWM}$	$\overline{Wr}$ Width (S3–S4) <sup>(4)</sup>	$T_{CY} - 50$		ns
$T_{WVME}$	$\overline{Wr}(\text{Ext})$ Width (S2–S4) <sup>(4)</sup>	$2T_{CY} - 50$		ns

**NOTES:**

1. Load = 1 TTL.
2. Load = 1 TTL + 50 pF.
3. Load = 1 TTL + ( $R_L = 3.3K$ ),  $V_{OH} = 3.3V$ .
4. Tracking Parameter.

5.  $\Delta T_{AK} < 50$  ns.
6.  $\Delta T_{DCL} < 50$  ns.
7.  $\Delta T_{DCT} < 50$  ns.

**A.C. CHARACTERISTICS—PERIPHERAL (SLAVE) MODE**

(Over Specified Operating Conditions)

**M8080A BUS PARAMETERS**
**READ CYCLE**

Symbol	Parameter	Min	Max	Unit	Comments
$T_{AR}$	Adr or $\overline{CS}$ ↓ Setup to $\overline{RD}$ ↓	0		ns	
$T_{RA}$	Adr or $\overline{CS}$ ↑ Hold from $\overline{RD}$ ↑	0		ns	
$T_{RD}$	Data Access from $\overline{RD}$ ↓	0	300	ns	(Note 2)
$T_{DF}$	DB → Float Delay from $\overline{RD}$ ↑	20	150	ns	
$T_{RR}$	$\overline{RD}$ Width	250		ns	

**WRITE CYCLE**

Symbol	Parameter	Min	Max	Unit	Comments
$T_{AW}$	Adr Setup to $\overline{WR}$ ↓	20		ns	
$T_{WA}$	Adr Hold from $\overline{WR}$ ↑	35		ns	
$T_{DW}$	Data Setup to $\overline{WR}$ ↑	200		ns	
$T_{WD}$	Data Hold from $\overline{WR}$ ↑	10		ns	
$T_{WW}$	$\overline{WR}$ Width	175		ns	

**OTHER TIMING**

Symbol	Parameter	Min	Max	Unit	Comments
$T_{RSTW}$	Reset Pulse Width	300		ns	
$T_{RSTD}$	Power Supply ↑ ( $V_{CC}$ ) Setup to Reset ↓	500		μs	
$T_r$	Signal Rise Time		20	ns	
$T_f$	Signal Fall Time		20	ns	
$T_{RSTS}$	Reset to First I/O $\overline{WR}$	2		t <sub>cy</sub>	

**NOTES:**

1. All timing measurements are made at the following reference voltages unless specified otherwise:

Input "1" at 2.0V, "0" at 0.8V.

Output "1" at 2.0V, "0" at 0.8V.

 2. M8257:  $C_L = 100$  pF.

**TRACKING PARAMETERS**

Signals labeled as Tracking Parameters (footnotes 4–7 under A.C. Specifications) are signals that follow similar paths through the silicon die. The propagation speed of these signals varies in the manufacturing process but the relationship between all these parameters is constant. The variation is less than or equal to 50 ns.

Suppose the following timing equation is being evaluated,

$$T_{A(MIN)} + T_{B(MAX)} \leq 150 \text{ ns}$$

and only minimum specifications exist for  $T_A$  and  $T_B$ . If  $T_{A(MIN)}$  is used, and if  $T_A$  and  $T_B$  are tracking parameters,  $T_{B(MAX)}$  can be taken as  $T_{B(MIN)} + 50$  ns.

$$T_{A(MIN)} + (T_{B(MIN)} + 50 \text{ ns}) \leq 150 \text{ ns}$$

\*If  $T_A$  and  $T_B$  are tracking parameters.

**A.C. TESTING INPUT, OUTPUT WAVEFORM**

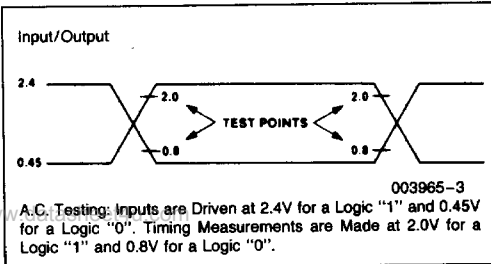

**A.C. TESTING LOAD CIRCUIT**

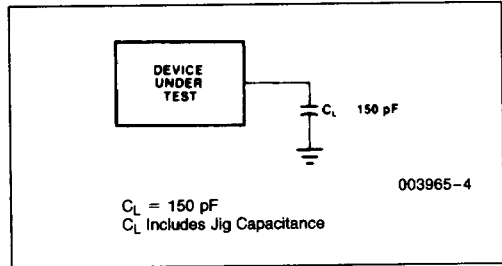

**WAVEFORMS**

**NOT READY SEQUENCE**

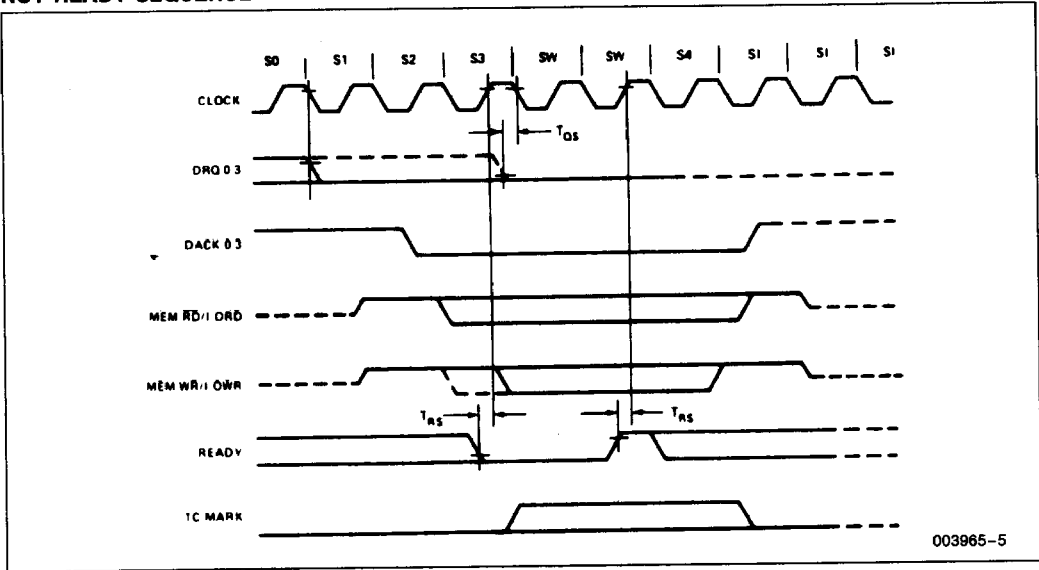

**CONTROL OVERRIDE**

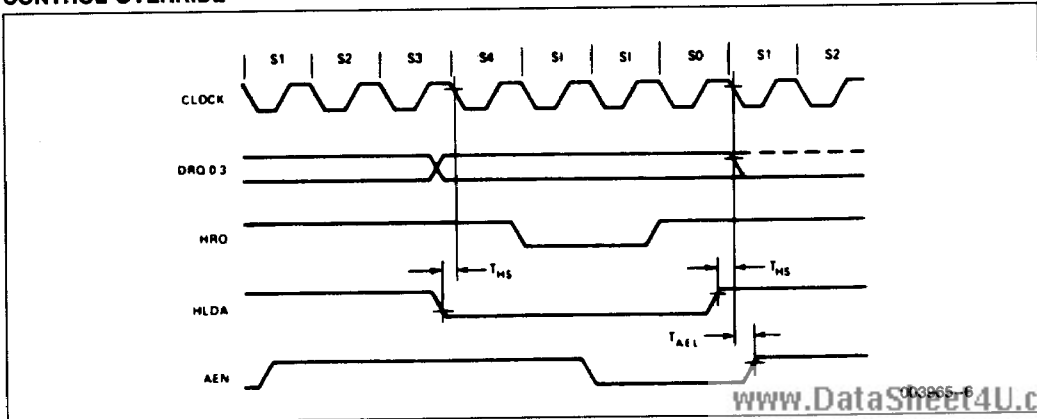



WAVEFORMS—PERIPHERAL MODE

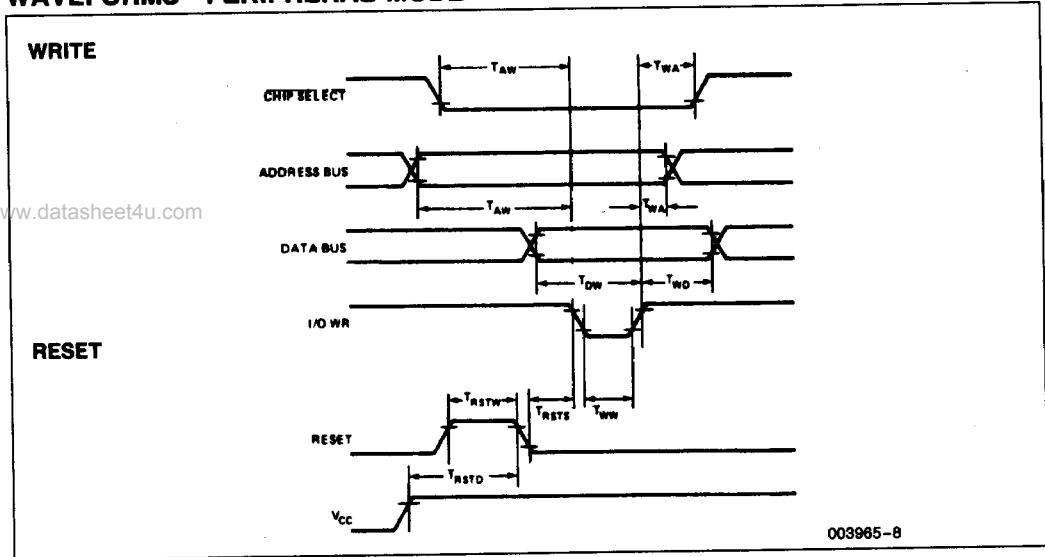

**READ**

