

UART-to- USB Bridge Controller

Features

- Operating voltage from 4.35V to 5.5V
- Universal Asynchronous Serial Receiver/Transmitter (UART) to Universal Serial Bus (USB) Bridge
- High efficient data transfer rate and low cost solution for UART-to-USB bridge, which has to connect 1200bps ~ 57.6Kbps UART device.
- Integrated USB transceiver for Low speed USB 1.5Mbps Specification, Version 1.1
- Embedded 3.3 V voltage regulator for USB data signals
- Built-in power-on-reset
- Supports suspend/normal mode for the power management
- 6 MHz external crystal or external ceramic resonator
- Support optional external serial EEPROM for USB VID, PID, product related string and external setting
- LEDs indicate the activity between USB and UART
- USB PC driver is available for Microsoft Windows 98 SE/Me/2000/XP
- Package:
 - Die form: MA100H
 - 28-SSOP: MA100L

General Description

The MA100 is a USB interface to a UART bridge controller, which allows high efficient data transfer rate between a UART device and a USB host. The MA100 is usually used in some existing devices with UART only, and work through it to provide easy connectivity between USB host and UART device.

The MA100 will be connected up to 57.6k bps UART, and the USB PC software driver is also supported for the Microsoft Windows 98 SE/Me/2000/XP environment. MA100 will be very suitable for hand-held game, data bank, I-toy, and other products that need to download/upload data through the PC system.

Pin Description

PIN Name	I/O	Description
TX	O	UART Transmit with an open-drain
RX	I	UART Receive with an open drain
BS0~2	I	Test pin
LBRS	I	Low baud rate select pin
USB_LED	O	LED for USB indication
TX_LED	O	LED for transmit indication
RX_LED	O	LED for receive indication
P0	O	Output pin
-RST	I	Reset pin, low active
TO0~1	I	Time-out between RX and USB
EE_A0	O	External EEPROM A0 address pin
EE_A1	O	External EEPROM A1 address pin
EE_SCL	O	External EEPROM serial clock input pin
EE_SDA	I/O	External EEPROM serial data pin
XTAL1	I	6MHz crystal or resonator in
XTAL2	I	6MHz crystal or resonator out
D+	I/O	USB data +
D-	I/O	USB data -
V _{CC}	I	Voltage supply
V _{SS}	I	Ground
V3.3	O	3.3V regulated output, a capacitor should be added on this pin

Pin Configuration

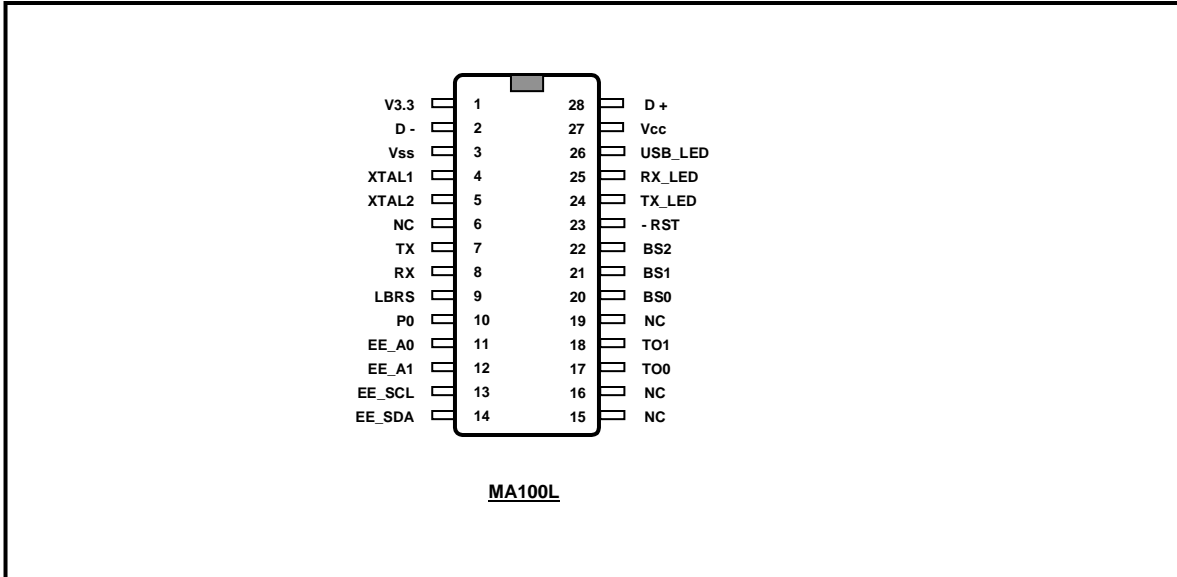

Application Notice

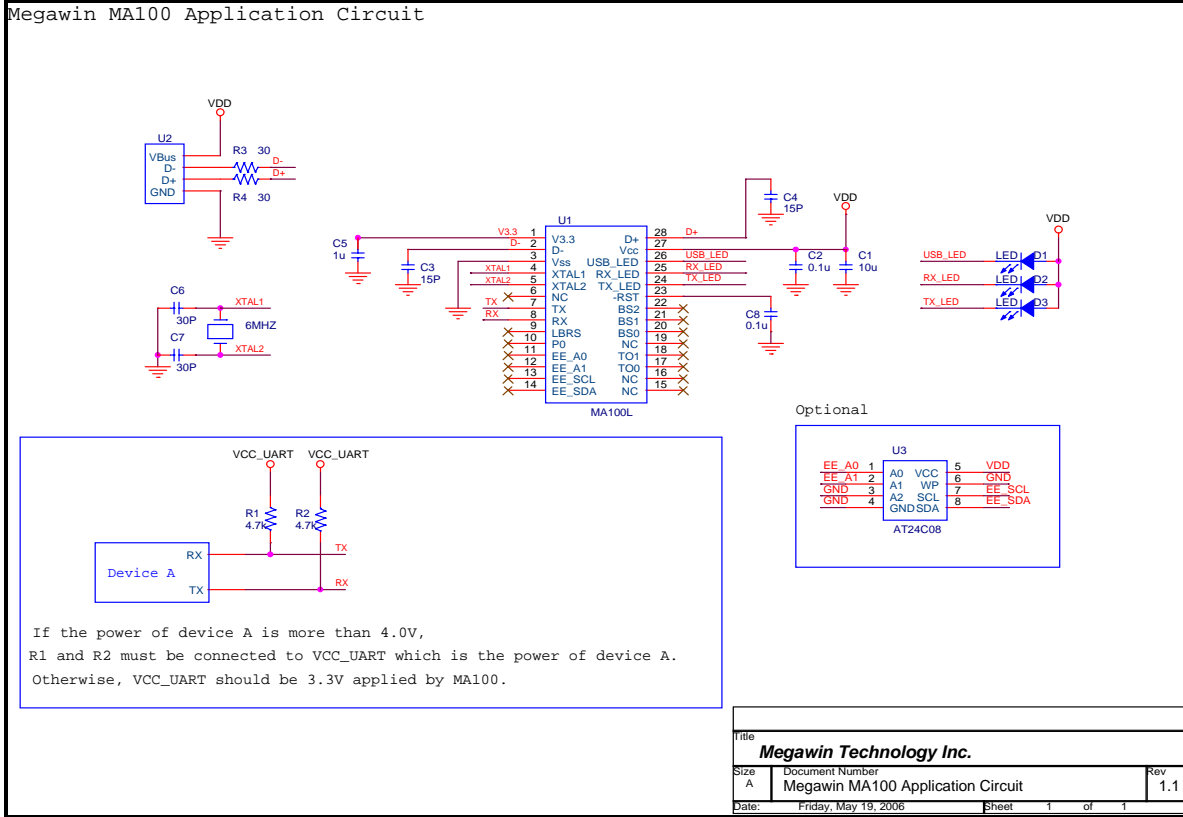

1. Time-out between RX and USB:

Time-out = $1/\text{baud rate} \times 2^n$, where $n=0$ for $TO1=1$ and $TO0=1$, $n=1$ for $TO1=1$ and $TO0=0$;
 $n=2$ for $TO1=0$ and $TO0=1$, $n=3$ for $TO1=0$ and $TO0=0$.

2. TX/RX-pin is an open-drain pin:

The TX/RX is an open-drain circuit, So, It decide that how much the suspend current, That is, If the power of device A is more than 4.0V, The VCC_UART's power must be connect to the power of device A, Otherwise, The VCC_UART's power should be connect to V3.3 pin of the MA100

3. UART's TX data delay

There is a time gap between the bytes transmitted via MA100's TX-pin. When the frequency of oscillator is 6 MHz, the minimum time gap is 10 microseconds. Users need to make sure the UART receiver device could move the data from the receiving buffer during the time gap, 10 us, to avoid it being overwritten by the following byte of data. The signal timing is shown in the following.

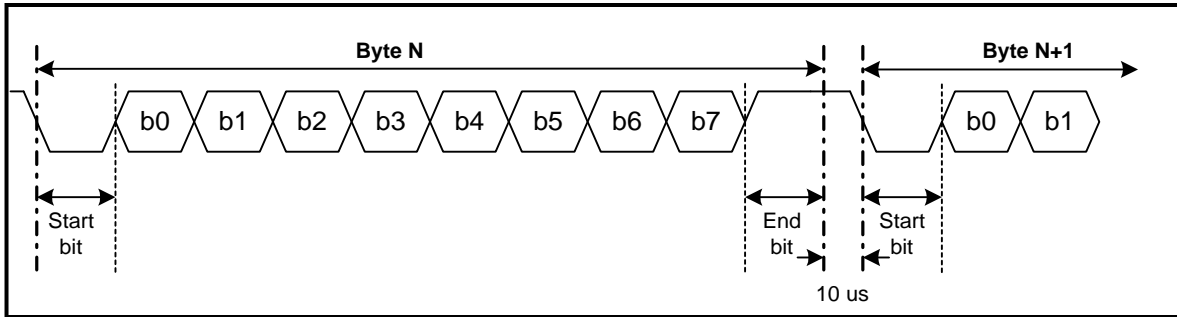

Fig 1. The signal timing of TX-pin

Absolute Maximum Rating

PARAMETER	RATING	UNIT
Supply Voltage to Ground Potential	-0.5 to +6.0	V
Maximum current per pin excluding V_{DD} and V_{SS}	25	mA
Maximum current out of GND	100	Ma
Maximum current out of VCC	100	Ma
Ambient Operating Temperature	0 to +70	°C
Storage Temperature	-40 to +125	°C

Note: Exposure to conditions beyond those listed under Absolute Maximum Ratings may adversely affect the life and reliability of the device.

DC Characteristics

($V_{DD}-V_{SS} = 5.0$ V, $F_{osc} = 6$ MHz, $T_a = 25^\circ$ C; unless otherwise specified)

PARAMETER	SYM.	CONDITIONS	MIN.	TYP.	MAX.	UNIT
Op. Voltage	V_{DD}	-	4.35	-	5.5	V
Op. Current	I_{OP}	No load (Ext.-V) In normal operation	-	-	20	Ma
Suspend Current	I_{SUS}	No load (Ext.-V)	-	300	450	μ A
Input High Voltage	V_{IH}	-	2	-	V_{DD}	V
Input Low Voltage	V_{IL}	-	0	-	0.8	V
USB function						
Static output high	V_{OH}	$R_L = 15$ Kohm to V_{SS}	2.8	-	3.6	V
Static output low	V_{OL}	No load	-	-	0.3	V
Differential input sensitivity	V_{DI}	$ (D+) - (D-) $	0.2	-	-	V
Differential common mode range	V_{CM}	Include V_{DI} range	0.8	-	2.5	V
Single ended receiver threshold	V_{SE}	-	0.8	-	2.0	V
Regulator supply voltage	$V_{3.3}$	$I_L = 4$ Ma	3.0	-	3.6	V
UART function						
Tx sink current	I_{OL}	$V_{OL} = 0.4$ V, $V_{DD} = 5.0$ V	-	4.0	-	Ma

AC Characteristics

(V_{DD}-V_{SS} = 5.0 V, F_{osc} = 6MHz, T_a = 25° C; unless otherwise specified)

PARAMETER	SYM.	CONDITIONS	MIN.	TYP.	MAX.	UNIT
USB function						
Internal operating frequency	f _{OP}		1.5	-	1.5	MHz
Transition time						
Rise time	t _R		75	-	300	Ns
Fall time	t _F		75	-	300	Ns
Rise/Fall time matching	t _{RFM}	t _R / t _F	80	-	125	%
Output signal crossover voltage	V _{CRS}		1.3	-	2.0	V
Low speed data rate	t _{DRAT}		1.4775	-	1.5225	Mbps
Source differential driver jitter						
To next transition	t _{UDJ1}	CL=350Pf measured at crossover point	-25	-	25	Ns
For paired transition	t _{UDJ2}		-14	-	14	Ns
Receiver data jitter tolerance						
To next transition	t _{DJR1}	CL=350Pf measured at crossover point	-75	-	75	Ns
For paired transition	t _{DJR2}		-45	-	45	Ns
Source EOP width	t _{EOPT}	Measured at crossover point	1.25	-	1.50	Us
Differential to EOP transition skew	t _{DEOP}	Measured at crossover point	-40	-	100	Ns
Receiver EOP width						
Must reject as EOP	t _{EOPR1}	Measured at crossover point	333	-	-	Ns
Must accept	t _{EOPR2}		667	-	-	Ns
UART function						
Duration from End-bit to Next Start-bit on Transmission	t _{TD}		10	-	-	Us
Duration from End-bit to Next Start-bit on Receiving	t _{RD}		0	-	-	Us

Package Dimensions

28-pin SSOP

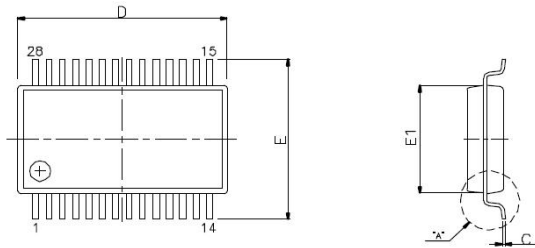

SYMBOLS	MIN.	NOM.	MAX.
A	—	—	2.0
A1	0.05	—	—
A2	1.62	1.75	1.85
b	0.22	—	0.38
c	0.09	—	0.25
D	9.90	10.20	10.50
E	7.40	7.80	8.20
E1	5.00	5.30	5.60
e	0.65 BSC		
L	0.55	0.75	0.95
R	0.09	—	—
α°	0°	4°	8°

UNIT : MM

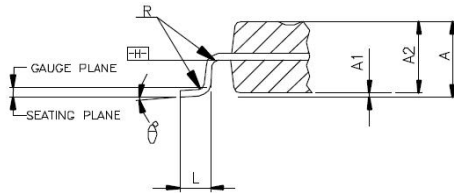
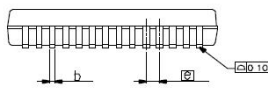

DETAIL : A

NOTES :

1. JEDEC OUTLINE : MO-15D AH

2. "D" AND "E1" DIMENSIONS DO NOT INCLUDE MOLD FLASH OR PROTRUSIONS, BUT DOES INCLUDE MOLD MISMATCH AND ARE MEASURED AT DATUM PLANE. MOLD PARTING LINE, MOLD FLASH OR PROTRUSION SHALL NOT EXCEED 0.20 mm PER SIDE.

3. DIMENSION b DOES NOT INCLUDE DAMBAR PROTRUSION/INTRUSION. ALLOWABLE DAMBAR PROTRUSION SHALL BE 0.13mm TOTAL IN EXCESS OF b DIMENSION AT MAXIMUM MATERIAL CONDITION. DAMBAR INTRUSION SHALL NOT REDUCE DIMENSION b BY MORE THAN 0.07mm AT LEAST MATERIAL CONDITION.

圖名: SHRINK SMALL OUTLINE PACKAGE S.3mm (206-m1)	比例: 1:1	材質: 銅	製程: 02
TITLE: BODY WIDTH, 0.65mm PITCH, 1.25mm LEAD LENGTH	圖號: J1-0228N-001	日期: 02	數量: 1
圖號: J1-0228N-001-02	日期: 02	數量: 1	

Pad Assignment

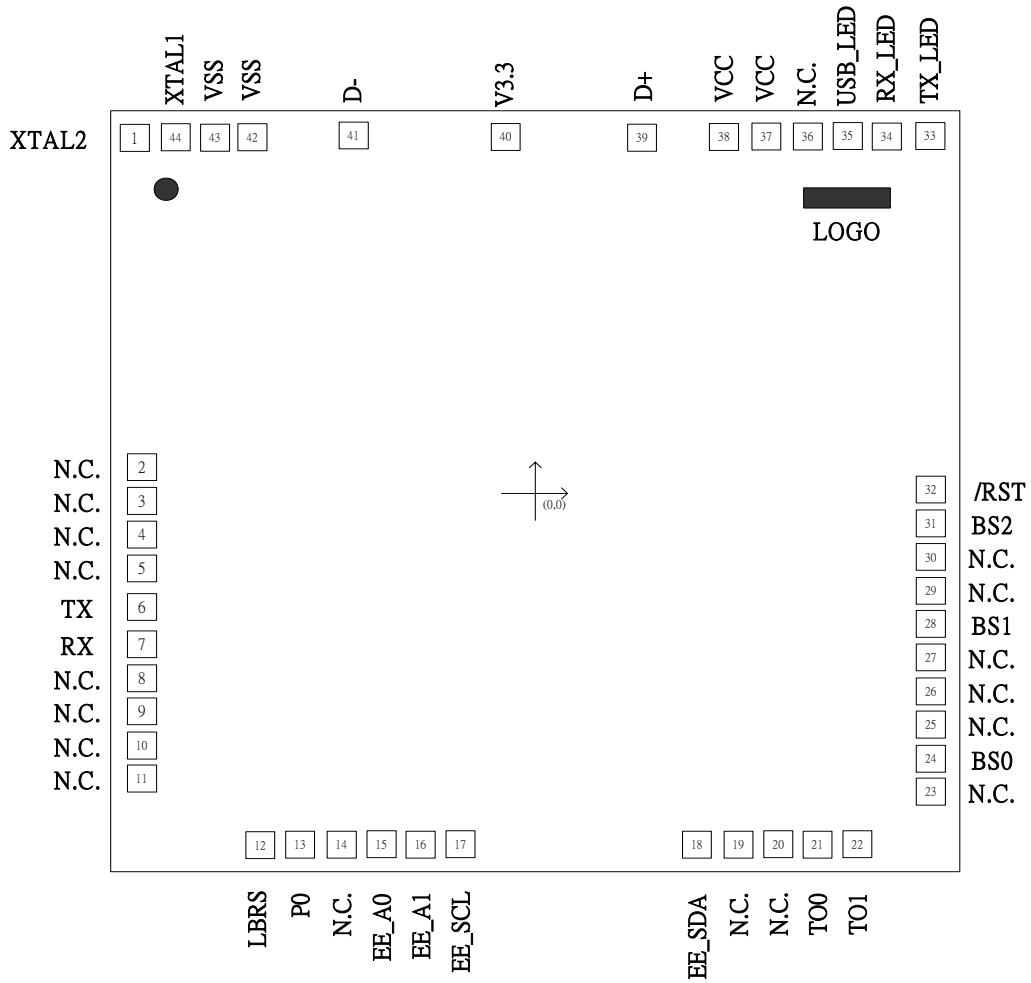

Revision History

Version	Date	Page	Description
A1	2006/05		Initial document
A2	2008/06		Update document
A3	2008/12		Formatting