

# MA1030

## OUTLINE DIMENSIONS

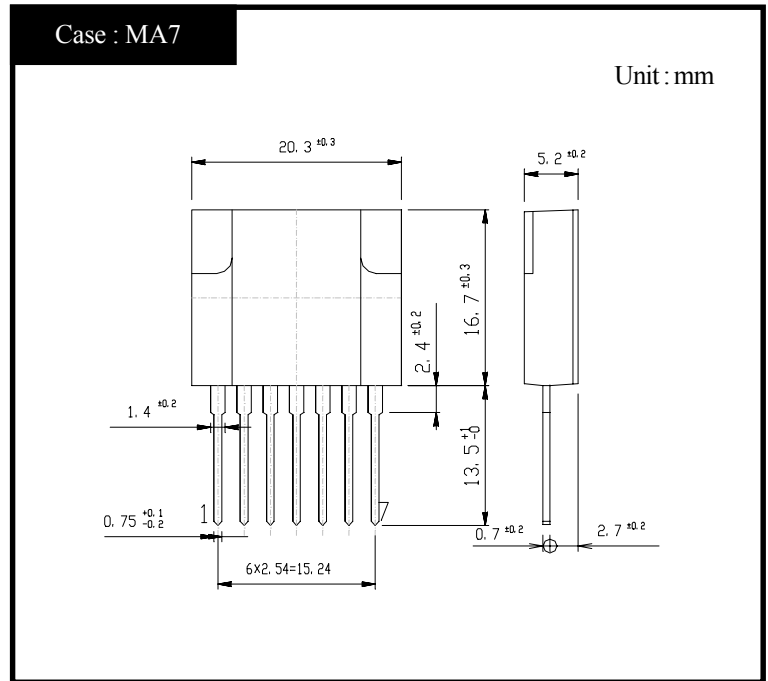

## RATINGS

### Absolute Maximum Ratings

Item	Symbol	Conditions	Ratings		Unit
			P Class	N Class	
Storage Temperature	T <sub>stg</sub>		-30~125	-30~125	°C
Operating Temperature	T <sub>op</sub>	Case Temperature	-20~125	-20~125	°C
Junction Temperature	T <sub>j</sub>		150	150	°C
Peak Input Voltage	V <sub>in</sub>	②+,④-,Fig.1 is Measurement Circuit of Peak Input Voltage V <sub>in</sub> and Collector Cutoff Current I <sub>CEX</sub> .	500	500	V
Input Current	I <sub>in</sub>	Pulse Pulse Width 150 μs MAX, Duty 1/2, Sawtooth Wave, Peak Value, ②+,④-	8	8	A
Maximum Operating Frequency	f(max)		200	200	kHz
Maximum Power Dissipation	P <sub>D</sub>	Ta=25°C	3	3	W
		Heatsink Tc=100°C	14	14	W
Dielectric Strength	V <sub>dis</sub>	Terminals To Case AC 1 min	2	2	kV
Insulation Resistance		Terminals To Case 500VDC	100	100	MΩ
Fold Back Control Voltage	V <sub>CONT(max)</sub>	Fold Control Resistance=0Ω Duty 1/2, ④,⑦	±8	±8	V
Fold Back Control Current	I <sub>CONT(max)</sub>	④-,⑥+	100	100	mA

### Electrical Characteristics (Tc=25°C)

Item	Symbol	Conditions	Ratings		Unit
			P Class	N Class	
Q1	Collector Cutoff Current	I <sub>CEX</sub>	V <sub>CE</sub> =500V, Fig.1 is Measurement Circuit of Peak Input Voltage V <sub>in</sub> and Collector Cutoff Current I <sub>CEX</sub> , ②+,④-		mA
	DC Current Gain	h <sub>FE</sub>	V <sub>CE</sub> = 5V, I <sub>C</sub> = 2.5A, ②+,④-,⑤I <sub>B</sub>		
	Collector to Emitter Saturation Voltage	V <sub>CE(sat)</sub>	I <sub>C</sub> =2.5A, I <sub>B</sub> =0.5A, ②+,④-,⑤I <sub>B</sub>		V
D1	Thermal Resistance	θ <sub>jc</sub>	Junction to Case		°C/W
	Reverse Current	I <sub>R</sub>	V <sub>R</sub> =450V,①+,②-		μA
Driving Saturation Voltage	V <sub>b(sat)</sub>	I <sub>C</sub> =1.5A, I <sub>B</sub> =0.3A, ⑤+,④-	Forward Voltage		V
			MIN 1.7		MIN 1.7
			MAX 2.3		MAX 2.3

● Standard Operating Condition • Design Standard For Application Circuit

Item	Conditions	Ratings		Unit
		P Class	N Class	
Input Rated Voltage		AC90~132	AC90~132	V
Output Nominal Wattage		50	50	W
Output Nominal Voltage		12	12	V
Output Nominal Current		4	4	A

● Standard Operating Condition • Standard Operating Characteristics (Ta=25°C)

Item	Conditions	Ratings		Unit		
		P Class	N Class			
Minimum Input Full Load Output Voltage	Vin=90V, I <sub>O</sub> =4A	12.0±0.6	12.0±0.6	V	Fig 2, ① Refer	
Maximum Input Light Load Output Voltage	Vin=132V, I <sub>O</sub> =0.4A	12.0±0.6	12.0±0.6	V	Fig 2, ② Refer	
AC Input Voltage	I <sub>O</sub> =4A	MAX 85	MAX 85	V		
Over Current Protection	Foldback Current	Vin=132V, V <sub>O</sub> =10V	MAX 6	MAX 6	A	Fig 2, ③ Refer
	Short Circuit	Vin=132V, R <sub>O</sub> =0.5Ω	Nodamage To Any Device, Automatic Recovery.		-	Fig 2, ④ Refer
Output Ripple Noise	Vin=90~132V, I <sub>O</sub> =0.4~4A	MAX 150	MAX 150	mV P-P		

Figure in ○=Terminal Sign

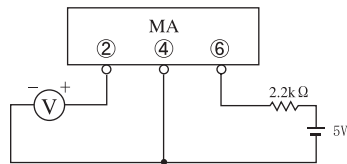

Fig1. Measurement Circuit

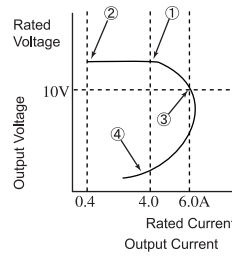
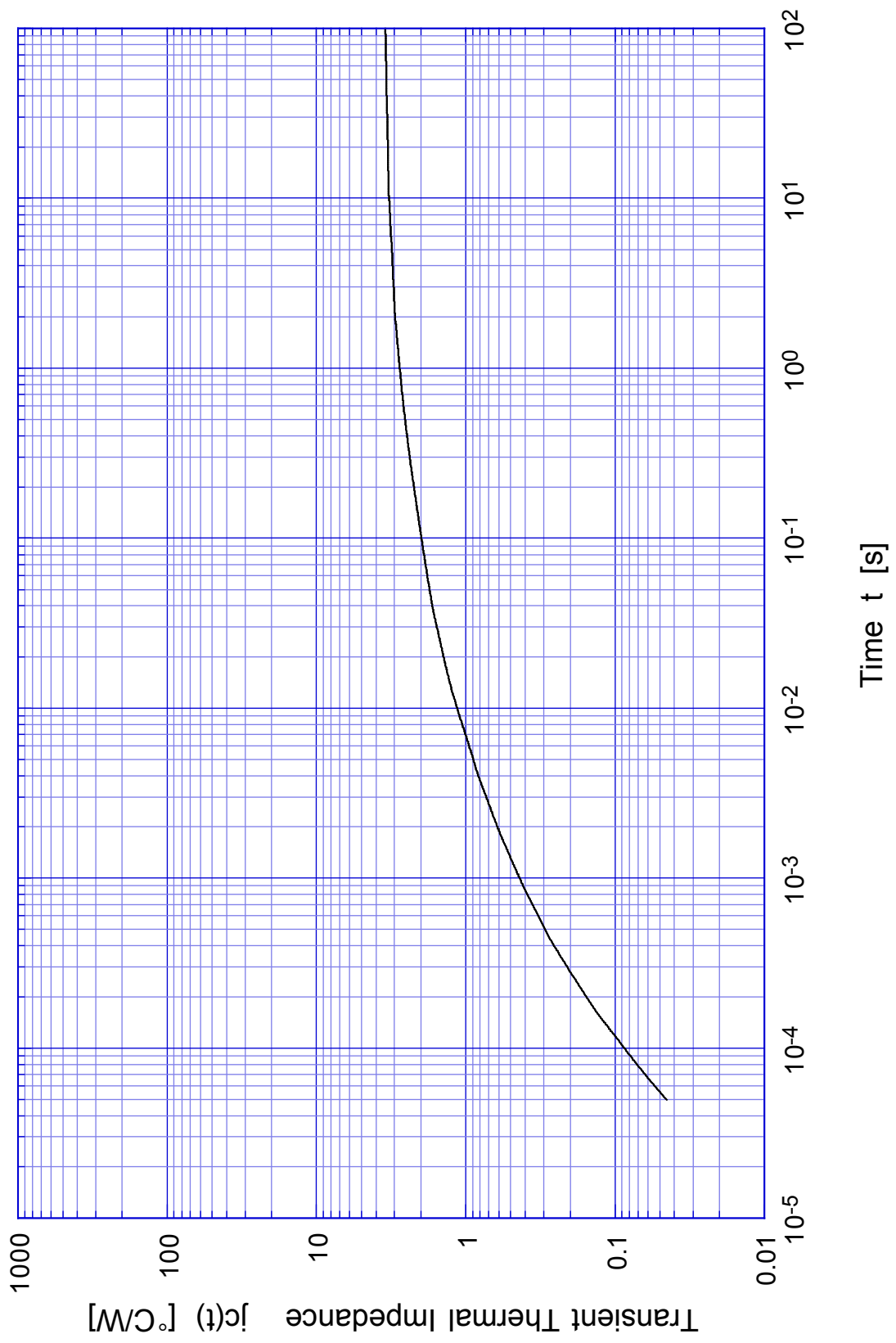

Fig2. Output Voltage/Current

# MA1030 Transient Thermal Impedance



MA1030

Forward Bias SOA

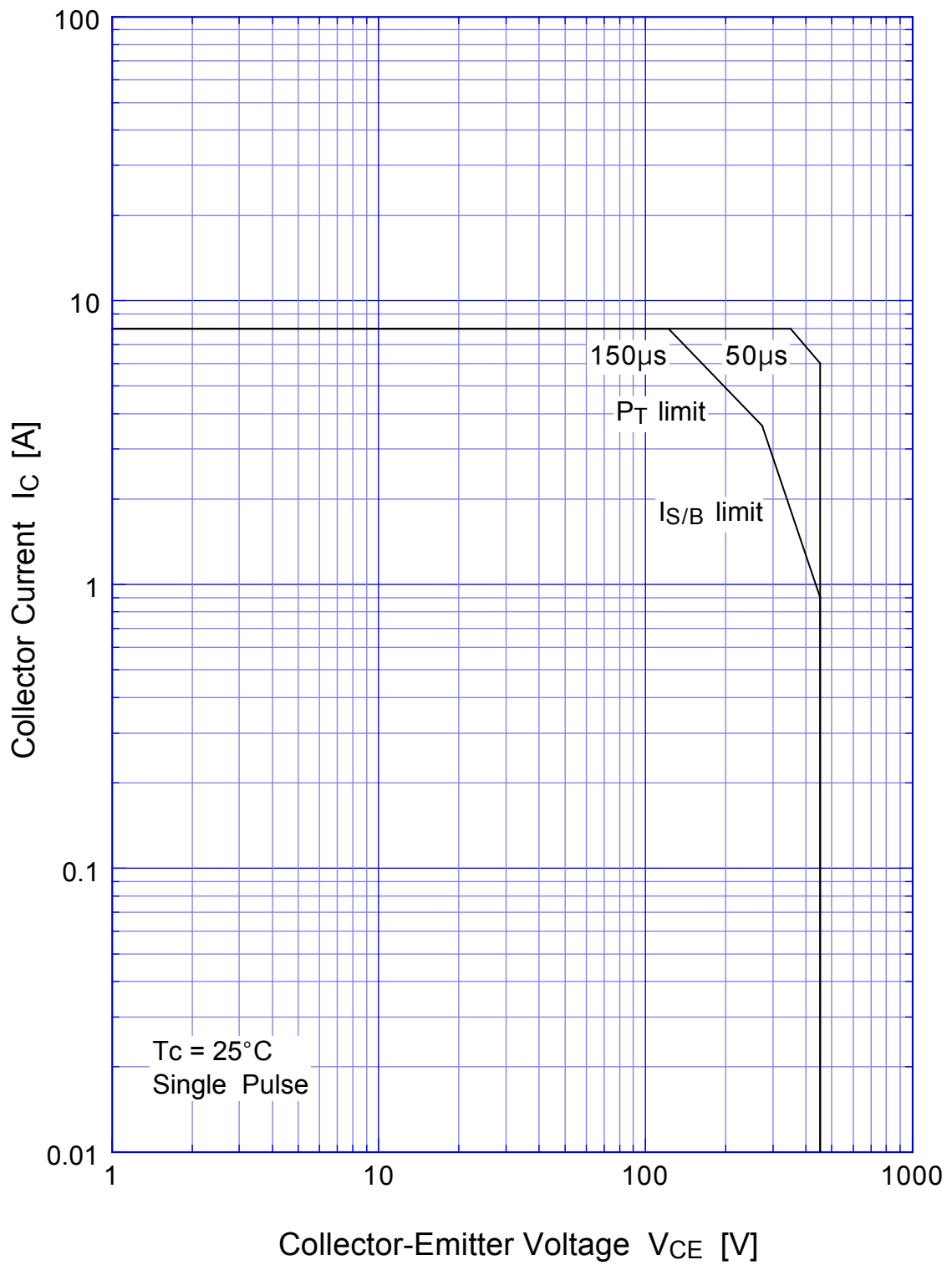

MA1030

Collector Current Derating

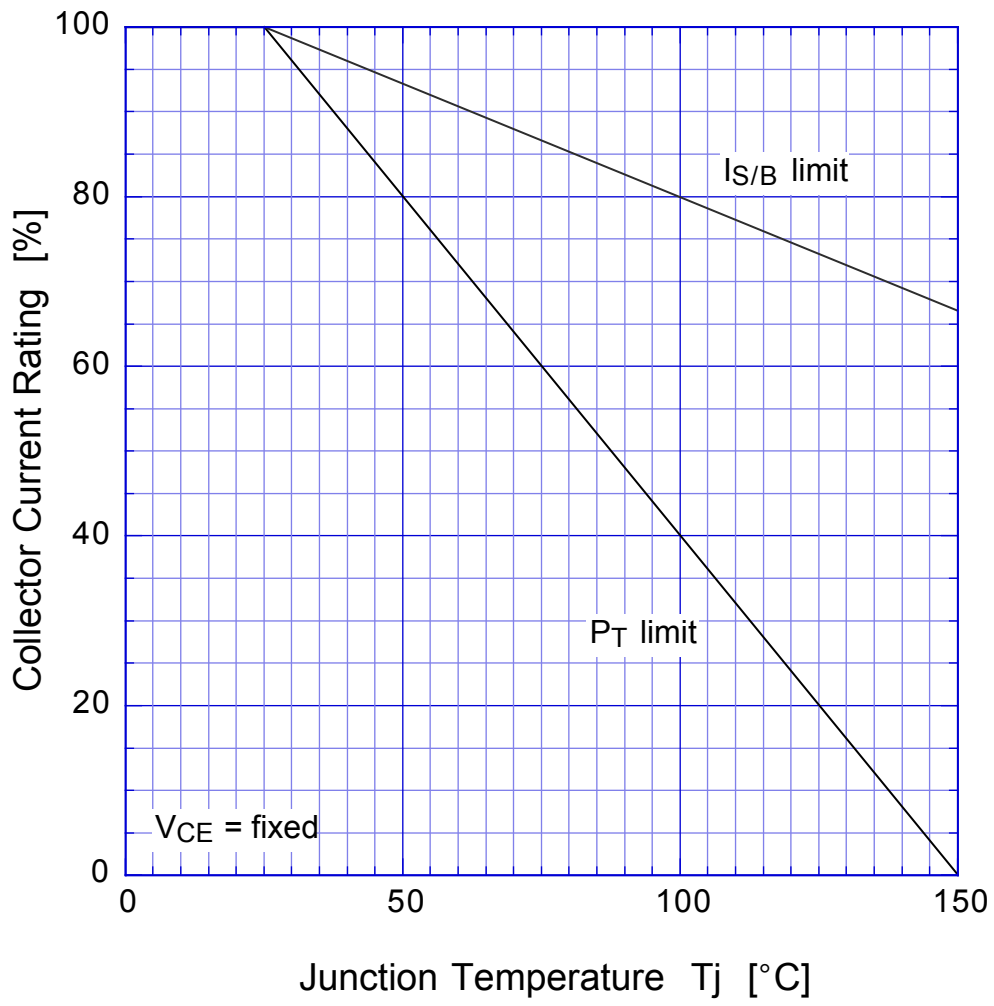

MA1030

Reverse Bias SOA

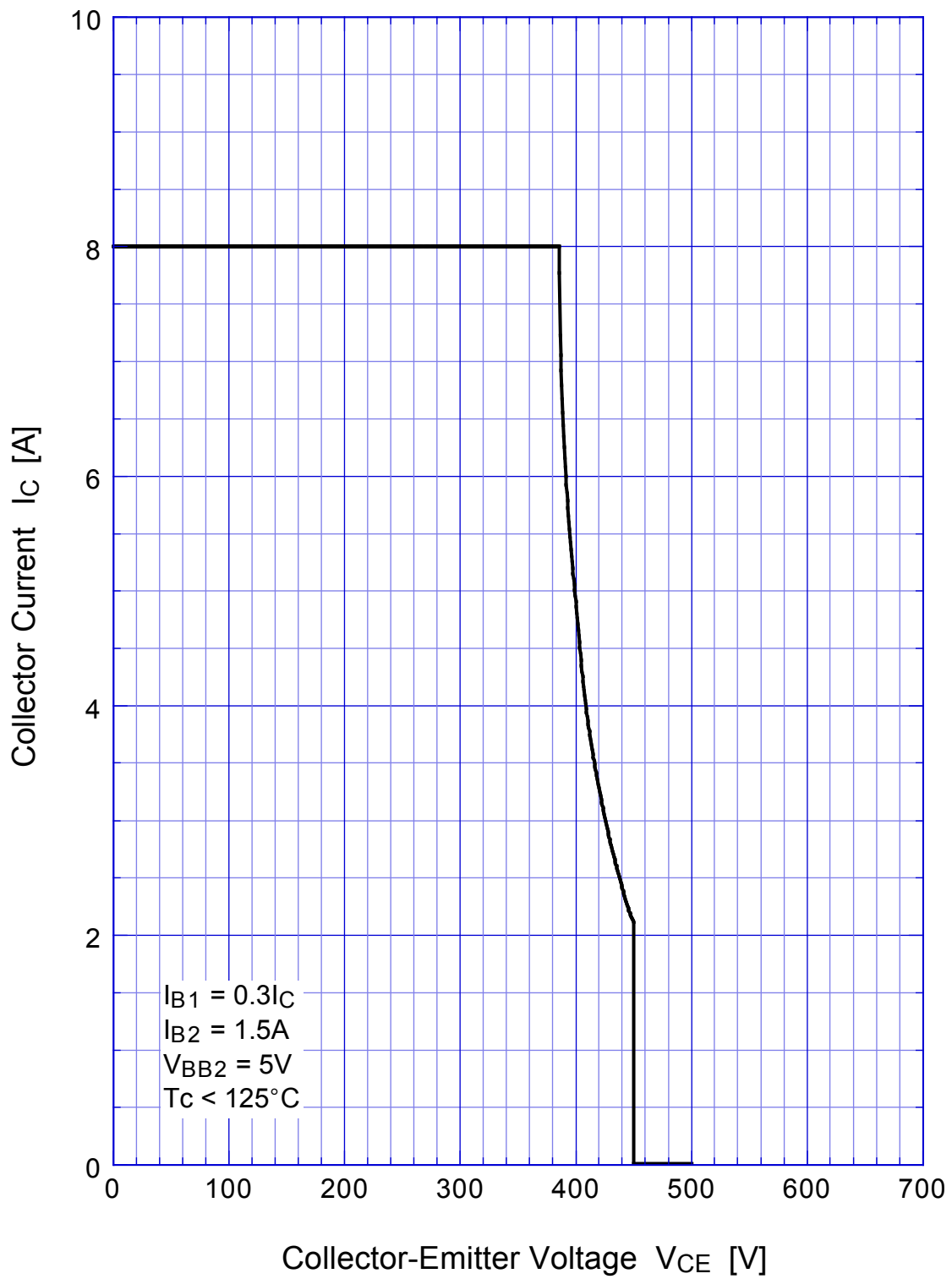

# MA1030

$h_{FE} - I_C$

