

MA2J113

Silicon epitaxial planar type

For switching circuits

■ Features

- Small S-mini type package, allowing high-density mounting
- Ensuring the average forward current capacity $I_{F(AV)} = 200$ mA
- High breakdown voltage ($V_R = 80$ V)

■ Absolute Maximum Ratings $T_a = 25^\circ\text{C}$

Parameter	Symbol	Rating	Unit
Reverse voltage (DC)	V_R	80	V
Peak reverse voltage	V_{RM}	80	V
Forward current (DC)	I_F	200	mA
Peak forward current	I_{FM}	600	mA
Non-repetitive peak forward surge current*	I_{FSM}	1	A
Junction temperature	T_j	150	$^\circ\text{C}$
Storage temperature	T_{stg}	-55 to +150	$^\circ\text{C}$

Noe) * : $t = 1$ s

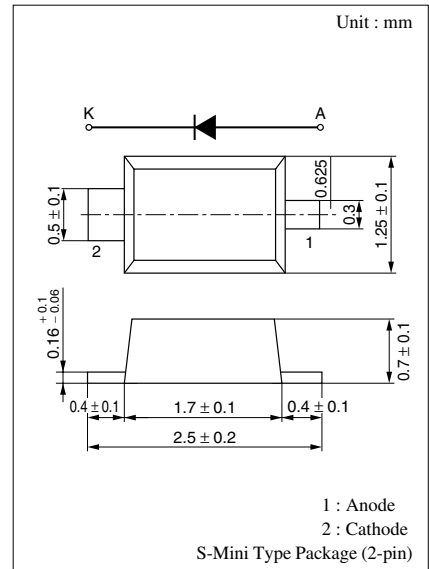

Marking Symbol: 1D

■ Electrical Characteristics $T_a = 25^\circ\text{C}$

Parameter	Symbol	Conditions	Min	Typ	Max	Unit
Reverse current (DC)	I_{R1}	$V_R = 15$ V			50	nA
	I_{R2}	$V_R = 75$ V			500	nA
	I_{R3}	$V_R = 75$ V, $T_a = 100^\circ\text{C}$			100	μA
Forward voltage (DC)	V_F	$I_F = 200$ mA			1.1	V
Terminal capacitance	C_t	$V_R = 0$ V, $f = 1$ MHz			4	pF
Reverse recovery time*	t_{rr}	$I_F = 10$ mA, $V_R = 6$ V $I_{tr} = 0.1 \cdot I_R$, $R_L = 100 \Omega$			10	ns

Note) 1. Rated input/output frequency: 100 MHz

2. * : t_{rr} measuring circuit

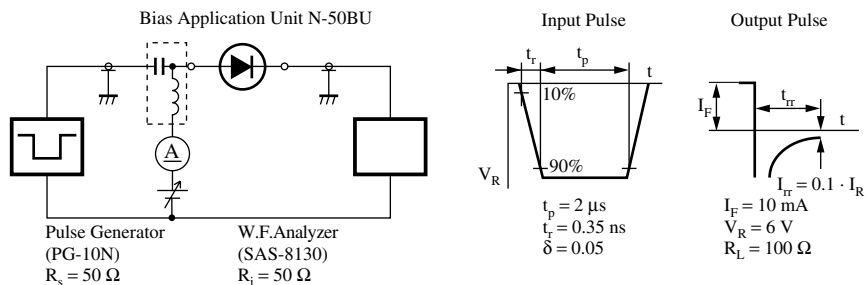

$I_F - V_F$

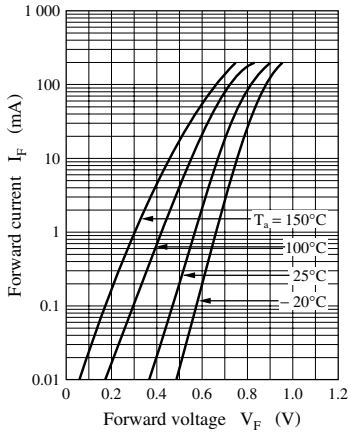

$I_R - V_R$

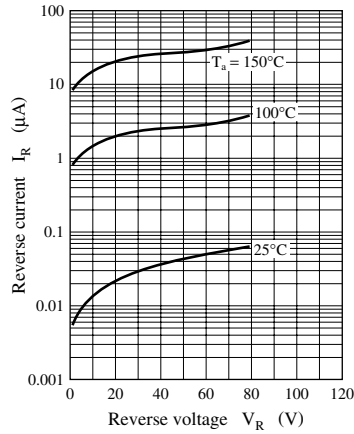

$V_F - T_a$

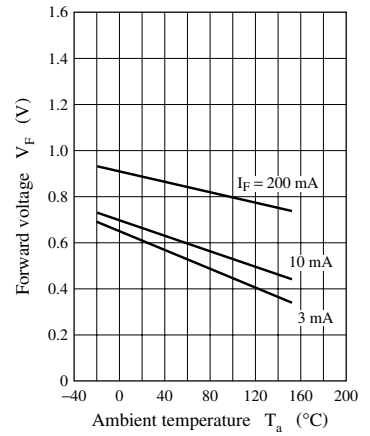

$I_R - T_a$

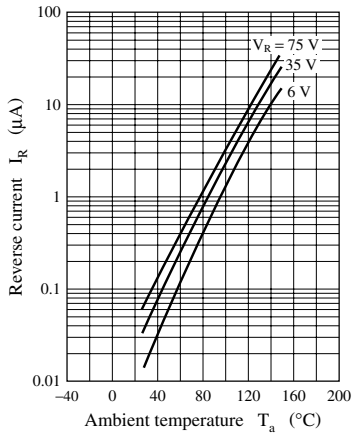

$C_t - V_R$

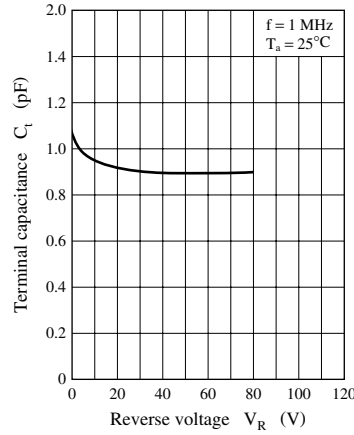

$I_{F(\text{surge})} - t_w$

