

MA2X334

Silicon epitaxial planar type

For UHF and VHF electronic tuners

■ Features

- Large capacitance ratio
- Small series resistance r_D
- Mini type package, allowing downsizing of equipment and automatic insertion through the taping package

■ Absolute Maximum Ratings $T_a = 25^\circ\text{C}$

Parameter	Symbol	Rating	Unit
Reverse voltage (DC)	V_R	30	V
Peak reverse voltage	V_{RM}	34	V
Forward voltage (DC)	I_F	20	mA
Junction temperature	T_J	150	$^\circ\text{C}$
Storage temperature	T_{stg}	-55 to +150	$^\circ\text{C}$

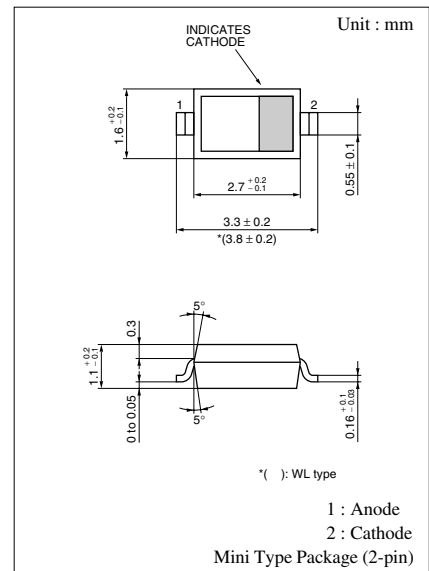

Marking Symbol: 6D

■ Electrical Characteristics $T_a = 25^\circ\text{C}$

Parameter	Symbol	Conditions	Min	Typ	Max	Unit
Reverse current (DC)	I_R	$V_R = 30\text{ V}$			10	nA
Diode capacitance	$C_{D(3V)}$	$V_R = 3\text{ V}, f = 1\text{ MHz}$	11.233		12.781	pF
	$C_{D(25V)}$	$V_R = 25\text{ V}, f = 1\text{ MHz}$	2.020		2.367	pF
	$C_{D(10V)}$	$V_R = 10\text{ V}, f = 1\text{ MHz}$	4.358		5.422	pF
	$C_{D(17V)}$	$V_R = 17\text{ V}, f = 1\text{ MHz}$	2.567		3.100	pF
Capacitance ratio	$C_{D(3V)}/C_{D(25V)}$		4.60		6.15	—
Capacitance difference	$C_{D(17V)}/C_{D(25V)}$		0.37			pF
Diode capacitance deviation	ΔC	$C_{D(3V)(10V)(17V)(25V)}$			2	%
Series resistance*	r_D	$C_D = 9\text{ pF}, f = 470\text{ MHz}$	0.38		0.72	Ω

Note) 1. Rated input/output frequency: 470 MHz

2. *: r_f measuring instrument: YHP MODEL 4191A RF IMPEDANCE ANALYZER

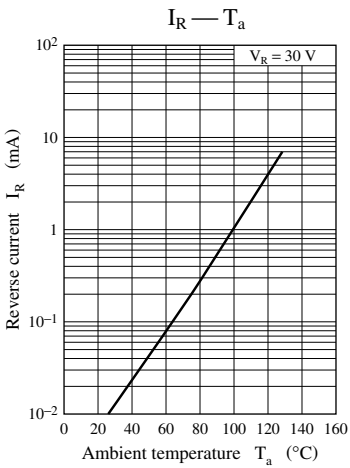
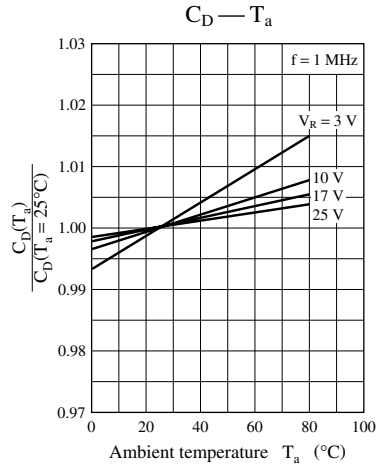
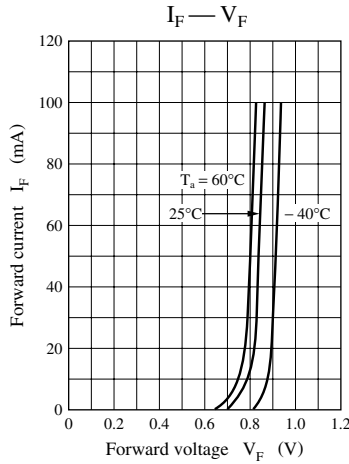
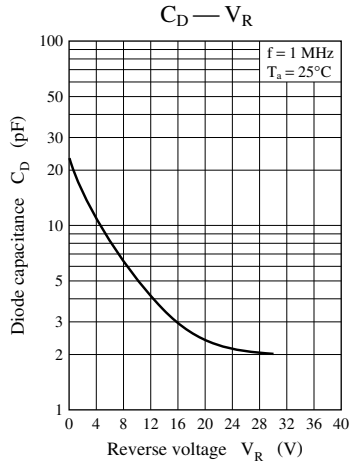

CD rank classification

•MA2X334B

Primary rank classification

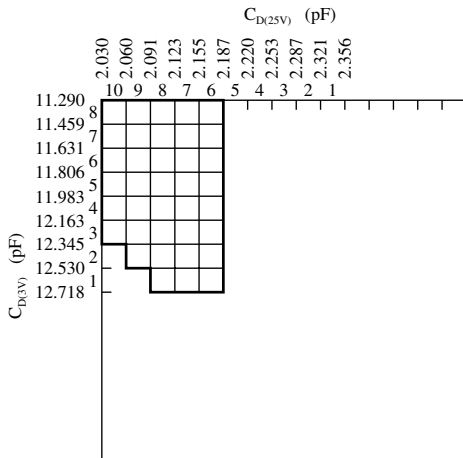

Secondary rank classification

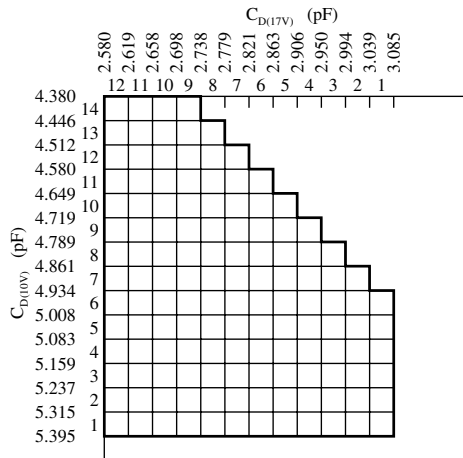

•MA2X3340G

Primary rank classification

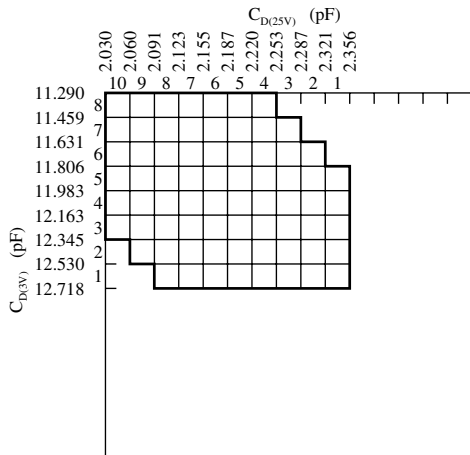

Secondary rank classification

