

Silicon Step Recovery Diodes

MA43000, MA44600 Series

V4

Features

- Low Transition Times
- Tight Capacitance Ranges
- High Voltage and Low Thermal Resistance for Higher Input Power
- Lead-Free (RoHs Compliant)

Description and Applications

The MA44600 series of Step Recovery diodes is designed for use in low and moderate power multipliers with output frequencies of up to 20 GHz. These Step Recovery diodes generate harmonics by storing a charge as the diode is driven to forward conduction by the positive voltage of the input signal. When the signal reverses polarity, this charge is extracted. The Step Recovery diode will appear as a low impedance current source until all the charge is extracted, then it will “snap” to a higher impedance. This causes a voltage pulse to form in the impulse circuit of the multiplier. Step Recovery diodes make excellent high order multipliers such as comb generators. They are also useful as efficient moderate power X2- X4 multipliers.

- High Order Narrow Band Moderate Power Multipliers (MA44600 series)
- Comb Generators (MA43592, MA43543)
- High Power Circuit Tested Multiplier (MA43000 Series)

Environmental Performance

The MA44600 and MA43000 series of diodes in ceramic packages are capable of meeting the tests dictated by the methods and procedures of the latest revisions of MIL-S-9500, MIL-STD-202 and MIL-STD-750 which specify mechanical, electrical, thermal and other environmental tests common to military semiconductor products.

Environmental Ratings PER MIL-STD-750

	Method	Level
Storage Temperature	1031	See maximum ratings
Temperature Cycle	1051	10 cycles, -65°C to +175°C
Shock	2016	500 g's
Vibration	2056	15 g's
Constant Acceleration	2006	20,000 g's
Humidity	1021	10 days

Specifications Subject to Change Without Notice.

Absolute Maximum Ratings @ T_A=+25 °C
(Unless Otherwise Noted)¹

Parameter	Absolute Maximum
Operating Range	-65°C to +175°C
Storage Range	-65°C to +200°C

1. Operation of this device above any one of these parameters may cause permanent damage.

Typical Case Styles

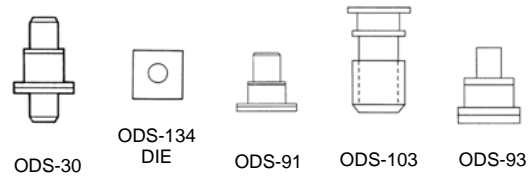

Maximum and Suggested Values of Snaptime (T_s) vs. Multiplier Output Frequency

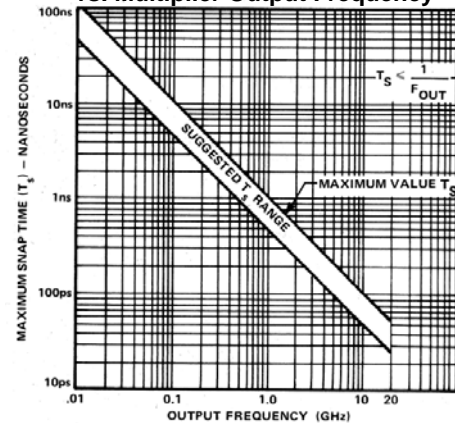

Suggested Junction Capacitance vs. Multiplier Output Frequency

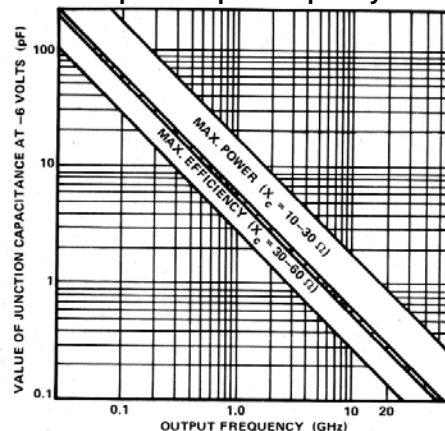

Silicon Step Recovery Diodes

MA43000, MA44600 Series

V4

Electrical Specifications @ T_A = +25 °C

Snap Varactors

Part Number ¹	Minimum Reverse Voltage ² (V _R)	Junction Capacitance(C _j) ³ Min./Max.	Minimum Lifetime (T _L)	Transition Time (T _s) ⁴	
		V _r =6V	I _f =10mA/ I _r =6mA	(pS)	(pS)
	(V)	(pF)	(nS)	Nominal	Max
MA44621A	20	0.200-0.300	7	50	100
MA44631A	30	0.300-0.500	8	70	100
MA44631C	30	0.700-0.900	8	70	100
MA44641A	40	0.400-0.600	12	90	150

High Power Circuit Tested Step Recovery Diodes

Part Number ¹	Minimum Reverse Voltage ² (V _R) Min./Max	Junction Capacitance (C _j) ³ Min./Max.	Lifetime (T _L) Min./Max.	Maximum Snap Time (T _s) ⁴	Maximum Thermal Resistance (θ _{jc})
		V _r =6V	I _f =10mA/ I _r =6mA		
	(V)	(pF)	(nS)	(pS)	(°C/W)
MA43000	85-105	3.00-4.50	250-500	100	12
MA43002	45-70	1.60-2.40	75-225	100	25
MA43004	30-45	0.45-0.85	20-50	100	45
Part Number ¹	Case Style	Minimum Output Power	Input Frequency	Output Frequency	Maximum Input Power
		(Watts)	(GHz)	(GHz)	(Watts)
MA43000	103	4.0	0.333	2.000	15
MA43002	91	1.5	2.000	6.000	5
MA43004	91	0.3	3.300	13.000	2

Notes:

- When ordering, specify the desired case style by adding the case designation as a suffix to the model number. Case styles for the MA44600 series are -30,-91 and -93. To order chip form, add the suffix "-134" to the model number. The nominal chip size for the MA44600 series is 15 mils.
- Reverse voltage (V_R) is measured at a reverse bias current of 10µA.
- Junction capacitance is measured at a reverse voltage of 6V and a frequency of 1MHz.
- Transition time is measured between 20% and 80% points on the voltage recovery trace. Test conditions are +10mA and -10 volts.

Specifications Subject to Change Without Notice.

2

M/A-COM Inc. and its affiliates reserve the right to make changes to the product(s) or information contained herein without notice. M/A-COM makes no warranty, representation or guarantee regarding the suitability of its products for any particular purpose, nor does M/A-COM assume any liability whatsoever arising out of the use or application of any product(s) or information.

- **North America** Tel: 800.366.2266 / Fax: 978.366.2266
- **Europe** Tel: 44.1908.574.200 / Fax: 44.1908.574.300
- **Asia/Pacific** Tel: 81.44.844.8296 / Fax: 81.44.844.8298

Visit www.macom.com for additional data sheets and product information.

Silicon Step Recovery Diodes

MA43000, MA44600 Series

V4

Electrical Specifications @ $T_A = +25^\circ\text{C}$

High Order Step Recovery Diode Varactors for Use in Comb Generation

Part Number ¹	Minimum Reverse Voltage ³ (V_R) Min./Max	Junction Capacitance (C_j) ⁴ Min./Max.	Lifetime (T_L) Min./Max.	Maximum Snap Time (T_s) ⁵	Maximum Thermal Resistance (θ_{jc})	Output Frequency ²	Maximum Input Power ²	Case Style ¹
		$V_r=6V$	$I_f=10mA/I_r=6mA$					
	(V)	(pF)	(pS)	(pS)	($^\circ\text{C}/W$)	(GHz)	(Watts)	
MA43592	25-40	0.20-0.30	9-27	90	70	1.00-12.00	1.0	30
MA43543	20-50	0.20-0.55	10-25	60	125	2.00-20.00	1.5	93

Notes:

- The standard case styles are indicated for each model number. For other available case styles, consult factory.
- This is an operable output frequency range and does not imply instantaneous bandwidth.
- Reverse voltage (V_R) is measured at a reverse bias current of $10\mu A$.
- Junction capacitance is measured at a reverse voltage of 6V and a frequency of 1MHz.
- Transition time is measured between 20% and 80% points on the voltage recovery trace. Test conditions are +10mA and -10 volts.

Suggested Design Considerations

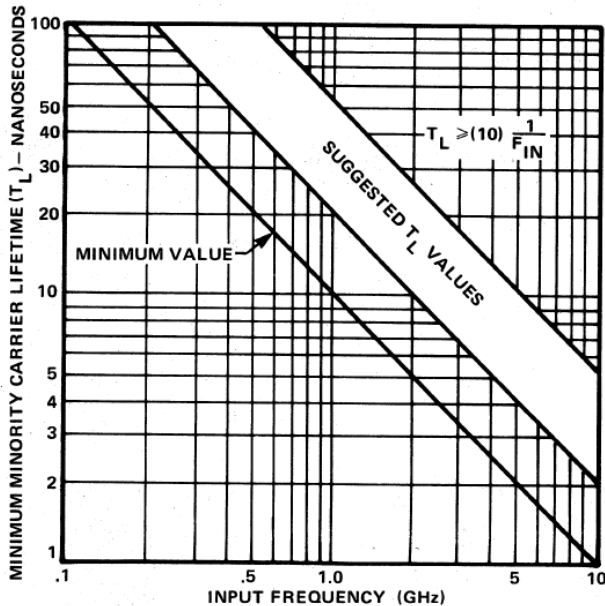

Minimum and Suggested Values of Minority Lifetime (TL) for SRD vs. Multiplier Input Frequency

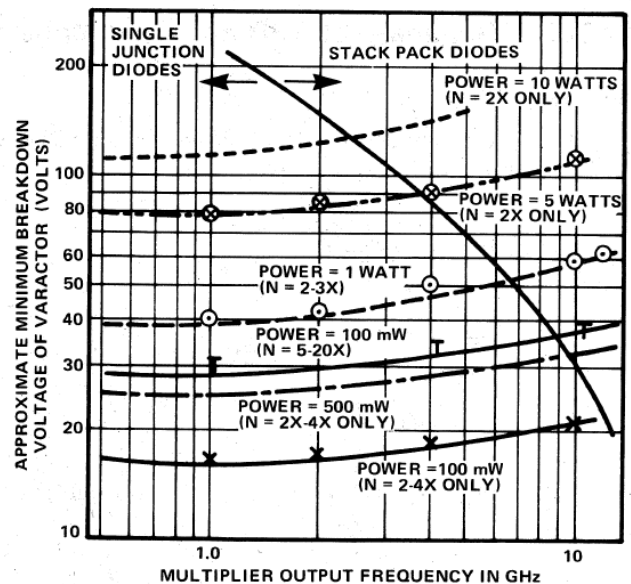

Approximate Minimum Breakdown Voltage Required for SRD at Various Output Power Levels vs. Output Frequency

Specifications Subject to Change Without Notice.

3

M/A-COM Inc. and its affiliates reserve the right to make changes to the product(s) or information contained herein without notice. M/A-COM makes no warranty, representation or guarantee regarding the suitability of its products for any particular purpose, nor does M/A-COM assume any liability whatsoever arising out of the use or application of any product(s) or information.

- North America Tel: 800.366.2266 / Fax: 978.366.2266
- Europe Tel: 44.1908.574.200 / Fax: 44.1908.574.300
- Asia/Pacific Tel: 81.44.844.8296 / Fax: 81.44.844.8298

Visit www.macom.com for additional data sheets and product information.

Case Styles

91

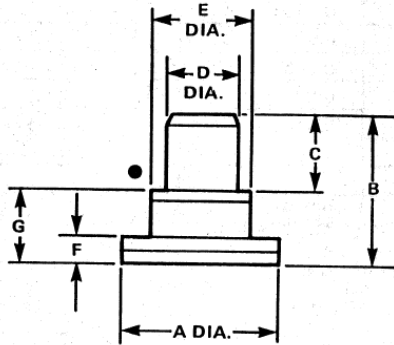

DIM.	INCHES		MILLIMETERS	
	MIN.	MAX.	MIN.	MAX.
A	0.119	0.127	3,02	3,23
B	0.115	0.129	2,92	3,28
C	0.060	0.064	1,52	1,63
D	0.060	0.062	1,52	1,57
E	0.077	0.083	1,96	2,11
F	0.016	0.024	0,41	0,61
G	0.055	0.065	1,40	1,65

C_P = 0.30 pF Typical
L_S = 0.40 nH Typical

93

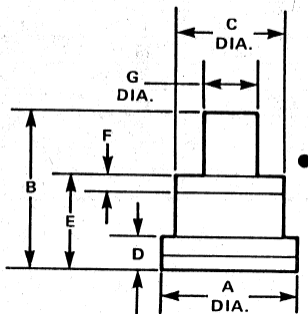

DIM.	INCHES		MILLIMETERS	
	MIN.	MAX.	MIN.	MAX.
A	0.059	0.069	1,50	1,75
B	0.070	0.080	1,78	2,03
C	0.047	0.053	1,19	1,35
D	—	0.015	—	0,38
E	0.040	0.050	1,02	1,27
F	0.004	0.010	0,10	0,25
G	0.024	0.026	0,61	0,66

C_P = 0.15 pF Typical
L_S = 0.17 nH Typical

103

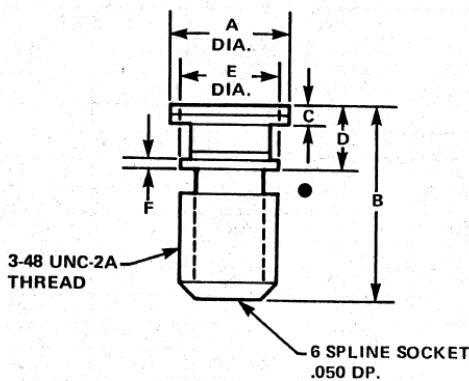

DIM.	INCHES		MILLIMETERS	
	MIN.	MAX.	MIN.	MAX.
A	0.119	0.127	3,02	3,23
B	0.188	0.208	4,78	5,28
C	0.016	0.024	0,41	0,61
D	0.058	0.071	1,47	1,80
E	0.098	0.102	2,49	2,59
F	0.009	0.011	0,23	0,28

Case Styles

30

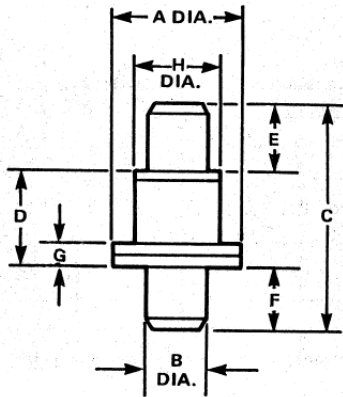

DIM.	INCHES		MILLIMETERS	
	MIN.	MAX.	MIN.	MAX.
A	0.119	0.127	3,02	3,22
B	0.060	0.064	1,52	1,63
C	0.205	0.225	5,21	5,72
D	0.085	0.097	2,16	2,46
E	0.060	0.064	1,52	1,63
F	0.060	0.064	1,52	1,63
G	0.016	0.024	0,41	0,61
H	0.079	0.083	2,01	2,11

$C_P = 0.18$ pF Typical
 $L_S = 0.40$ nH Typical

134

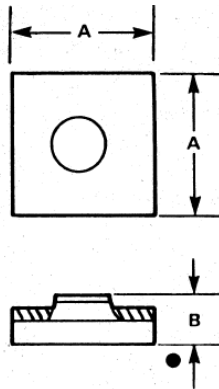

DIM.	INCHES		MILLIMETERS	
	MIN.	MAX.	MIN.	MAX.
A	0.0135	0.0165	0,34	0,42
B	0.0035	0.0065	0,09	0,17