

# Surface Mount GaAs Tuning Varactors

## MA46 Series

V3.00

### Features

- Low Cost
- Surface Mount Packages
- Very High Quality Factor
- Constant Gamma Abrupt Junction: 0.5  
Hyperabrupt Junctions: 0.75, 1.25 and 1.5
- Capacitance Ratio to 10:1
- Case Style 1056 is Hermetic and may be  
Screened to JANTX levels
- Tape and Reel Packaging Available

### Description

M/A-COM offers four families of low cost surface mount gallium arsenide tuning varactors. All families have silicon nitride protected junctions for low leakage current and high reliability.

The **MA46H500 through MA46H504** family has hyperabrupt junctions with constant gamma of 1.5 from 2 to 12 volts and high quality factor.

The **MA46H200 through MA46H206** family has hyperabrupt junctions with constant gamma of 1.25 from 2 to 20 volts and higher quality factor.

The **MA46H070 through MA46H073** family has hyperabrupt junctions with constant gamma of 0.75 from 0 to 20 volts and very high quality factor.

The **MA46504 through MA46506** family has abrupt junctions with constant gamma of 0.5 from 0 to 30 volts and the highest quality factor.

### Applications

The **MA46H500 through MA46H504 (gamma 1.5)** family of constant gamma hyperabrupt GaAs tuning varactors is designed for wide bandwidth VCOs and voltage tuned filters where limited bias voltage is available. These varactors have greatest capacitance change versus voltage at the cost of slightly lower quality factor than the other families of GaAs varactors.

### Case Styles

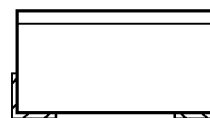

1056

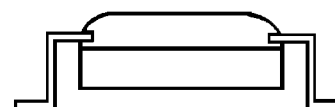

1088

The **MA46H200 through MA46H206 (gamma 1.25)** family of constant gamma hyperabrupt GaAs tuning varactors has the largest capacitance ratio of the families of GaAs varactors and high quality factor. These diodes are very well suited for wide bandwidth VCOs and VTFs where the optimum combination of very wide tuning range and high quality factor is required.

The **MA46H070 through MA46H073 (gamma 0.75)** family of constant gamma hyperabrupt GaAs tuning varactors has quality factor approaching that of abrupt junction varactors, but higher capacitance change versus tuning voltage. These diodes are very well suited for narrower bandwidth VCOs and VTFs where wide tuning range and very high quality factor are required.

The **MA46504 through MA46506 (gamma 0.5)** family of constant gamma abrupt GaAs tuning varactors has the highest quality factor. These diodes are very well suited for narrower bandwidth VCOs and VTFs where highest quality factor is of paramount concern.

Specifications Subject to Change Without Notice.

M/A-COM, Inc.

North America: Tel. (800) 366-2266  
Fax (800) 618-8883

■ Asia/Pacific: Tel. +81 3 3263 8761  
Fax +81 3 3263 8769

■ Europe: Tel. +44 (1344) 869 595  
Fax +44 (1344) 300 020

**Absolute Maximum Ratings @ 25°C**

Parameter	Case 1056	Case 1088
Operating Temperature	-65°C to +150°C	-65°C to +125°C
Storage Temperature	-65°C to +200°C	-65°C to +125°C
Reverse Voltage	Breakdown Voltage	
Forward Current	50 mA @ 25°C	
Power Dissipation	50 mW @ +25°C, derate linearly to 0 mW at maximum operating temperature	

**Electrical Specifications @ 25°C**

**Gamma 0.5 Abrupt Tuning Varactors**

Breakdown Voltage @ 10 μA = 30 V minimum  
 Reverse Current @ 24 V = 100 nA maximum  
 Gamma = 0.48 - 0.50, V<sub>R</sub> = 0 to 30 V

Model Number	Total Capacitance (pF)	Nominal Total Capacitance Ratio (C <sub>T0</sub> /C <sub>T30</sub> )	Typical Q
	f=1 MHz V <sub>R</sub> =4 Volts	f=1 MHz V <sub>R</sub> =0/V <sub>R</sub> =30	f=50 MHz V <sub>R</sub> =4 Volts
MA46504	0.5 - 0.7	2.1	6000
MA46505	0.9 - 1.1	2.8	5700
MA46506	2.7 - 3.3	3.4	4500

**Typical Performance Curves**

CAPACITANCE vs REVERSE VOLTAGE

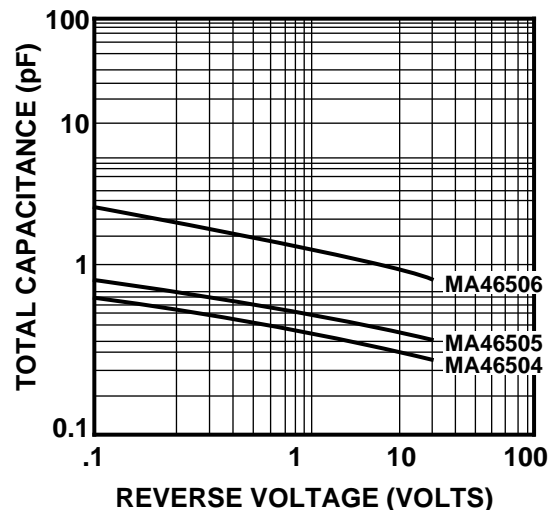

**Electrical Specifications @ 25°C**

**Gamma 0.75 Hyperabrupt Tuning Varactors**

Breakdown Voltage @ 10 μA = 20 V minimum  
 Reverse Current @ 16 V = 100 nA maximum  
 Gamma = 0.68 - 0.83, V<sub>R</sub> = 0 to 20 V

Model Number	Total Capacitance (pF)	Nominal Total Capacitance Ratio (C <sub>T0</sub> /C <sub>T20</sub> )	Typical Q
	f = 1 MHz V <sub>R</sub> = 4 Volts	f = 1 MHz V <sub>R</sub> = 0/V <sub>R</sub> =20	f = 50 MHz V <sub>R</sub> = 4 Volts
MA46H070	0.5 - 0.7	5.5	4500
MA46H071	0.9 - 1.1	6.4	4500
MA46H072	2.7 - 3.3	7.5	3000
MA46H073	4.5 - 5.5	7.5	2200

CAPACITANCE vs REVERSE VOLTAGE

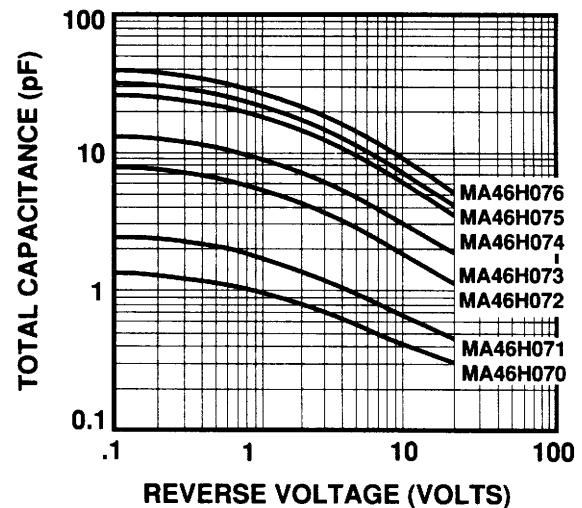

Specifications Subject to Change Without Notice.

**Electrical Specifications @ 25°C**

**Gamma 1.25 Hyperabrupt Tuning Varactors**

Breakdown Voltage @ 10  $\mu$ A = 22 V minimum  
 Reverse Current @ 16 V = 100 nA maximum  
 Gamma = 1.13 - 1.38,  $V_R$  = 2 to 20 V

Model Number	Total Capacitance (pF)	Nominal Total Capacitance Ratio ( $C_{T2}/C_{T20}$ )	Typical Q
	f = 1 MHz $V_R$ = 4 Volts	f = 1 MHz $V_R$ = 2/ $V_R$ =20	f=50 MHz $V_R$ = 4 Volts
MA46H200	0.5 - 0.7	3.0	3000
MA46H201	0.9 - 1.1	4.1	3000
MA46H202	2.7 - 3.3	5.6	2000
MA46H203	4.5 - 5.5	10.0	1500
MA46H204	9.0 - 11.0	10.0	1500
MA46H205	10.8 - 13.2	10.0	1500
MA46H206	13.5 - 16.5	10.0	1500

**Electrical Specifications @ 25°C**

**Gamma 1.5 Hyperabrupt Tuning Varactors**

Breakdown Voltage @ 10 $\mu$ A = 18 V minimum  
 Reverse Current @ 14 V = 100 nA maximum  
 Gamma = 1.4 - 1.6,  $V_R$  = 2 to 12 V

Model Number	Total Capacitance (pF)	Nominal Total Capacitance Ratio ( $C_{T2}/C_{T12}$ )	Typical Q
	f = 1 MHz $V_R$ = 4 Volts	f = 1 MHz $V_R$ = 2/ $V_R$ = 12	f = 50 MHz $V_R$ = 4 Volts
MA46H500	0.5 - 0.7	2.8	2500
MA46H501	0.9 - 1.1	3.9	2500
MA46H502	2.7 - 3.3	5.0	1800
MA46H503	4.5 - 5.5	8.1	1200
MA46H504	9.0 - 11.0	8.1	1200

**Typical Performance Curves**  
**Capacitance vs Reverse Voltage**

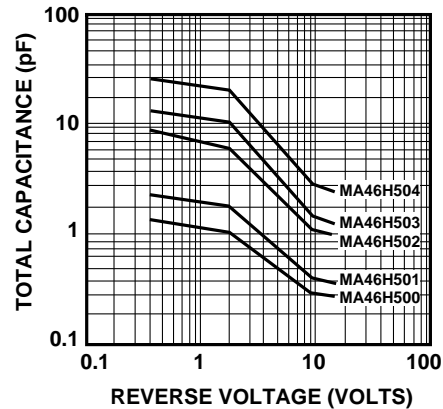
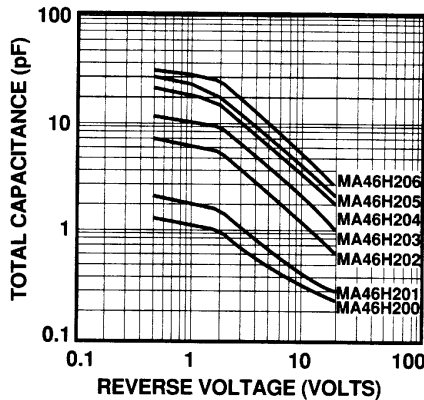

**Temperature Coefficient of Capacitance vs Reverse Voltage**

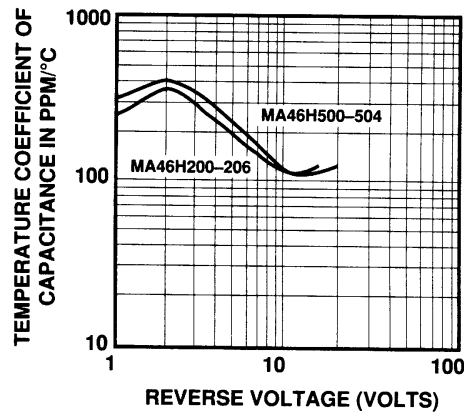
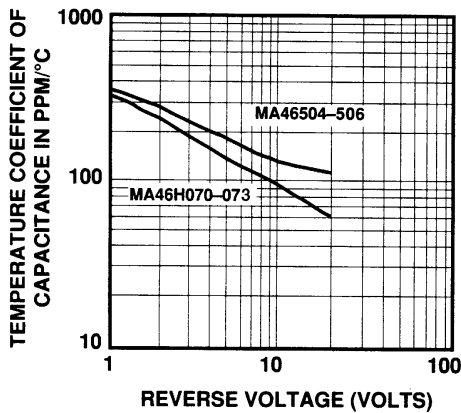

Specifications Subject to Change Without Notice.

**Ordering Information**

These GaAs tuning varactors are available in either case style as shown. When ordering, specify the desired case style by adding the case designation as a suffix to the model number. For example, a MA46H200-1088 specifies a 1.25 gamma hyperabrupt tuning diode in case style 1088.

**Case Styles**

**1056**

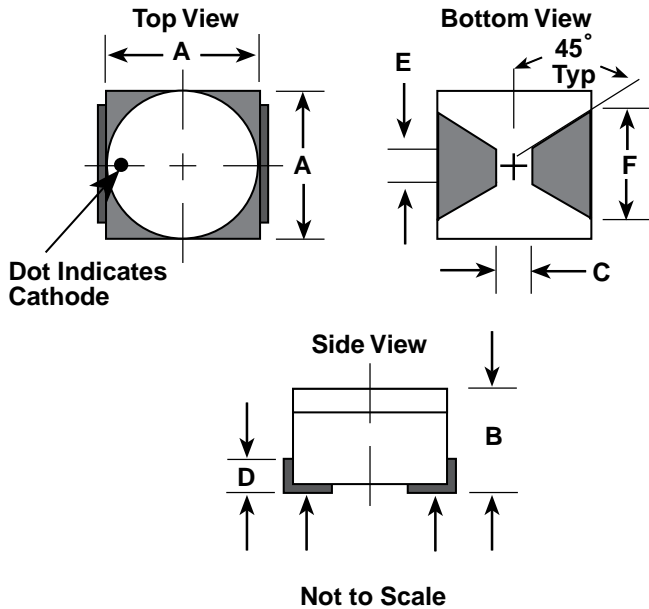

DIM.	INCHES		MILLIMETERS	
	MIN.	MAX.	MIN.	MAX.
A	0.065	0.075	1.72	1.90
B	0.034	0.041	0.86	1.04
C	0.030	0.036	0.76	0.91
D	0.013	0.017	0.33	0.44
E	0.010	0.014	0.25	0.36
F	0.043	0.053	1.09	1.35

Package Capacitance: 0.15 pF Typical  
 Package Inductance: 0.45 nH Typical

**1088**

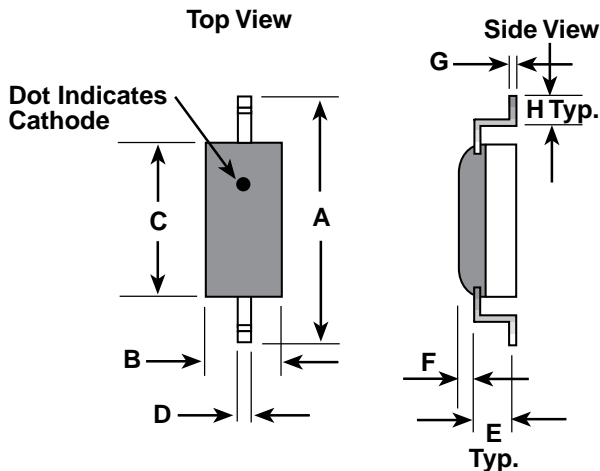

DIM.	INCHES		MILLIMETERS	
	MIN.	MAX.	MIN.	MAX.
A	0.175	0.195	4.44	4.95
B	0.040	0.050	1.02	1.27
C	0.085	0.095	2.16	2.41
D	0.015	0.025	0.38	0.64
E	0.010	0.015	0.25	0.38
F	0.015	0.020	0.38	0.51
G	0.004	0.006	0.10	0.15
H	0.020	0.030	0.51	0.76
J	0.013	0.033	0.33	0.84
K	0.003	0.005	0.08	0.13

Package Capacitance: 0.13 pF Typical  
 Package Inductance: 0.50 nH Typical

Specifications Subject to Change Without Notice.