

# Silicon Double Balanced HMIC™ Mixer, 1300 - 1900 MHz

MA4EX180M-1225

## Features

- Low Cost Miniature Plastic Package
- 5.5 dB Typical Conversion Loss at 1550 MHz
- 6.0 dB Typical Conversion Loss at 1800 MHz
- +7 to +13 dBm LO Drive
- HMIC™ Patented Process
- Silicon Medium Barrier Schottky Diodes
- DC - 500 MHz IF Bandwidth

## Description

M/A-COM's MA4EX180M-1225 is a silicon monolithic 1300-1900 MHz, medium barrier, double balanced mixer in a low cost miniature surface mount SOT-25 package. The die uses M/A-COM's unique HMIC™ silicon/glass process to achieve low loss passive elements while retaining the advantages of medium barrier silicon Schottky diodes.

## Applications

These mixers are well suited for high volume wireless and cellular applications where small size and repeatability are required. Typical applications include frequency conversion, modulation, and demodulation for receivers and transmitters in both portable cellular and base station applications.

## Absolute Maximum Ratings<sup>1</sup>

Parameter	Absolute Maximum
Operating Temperature	-40 °C to +85 °C
Storage Temperature	-65 °C to +150 °C
Incident LO Power	+20 dBm
Incident RF Power	+20 dBm

1. Exceeding these limits may cause permanent damage.

## Package Outline

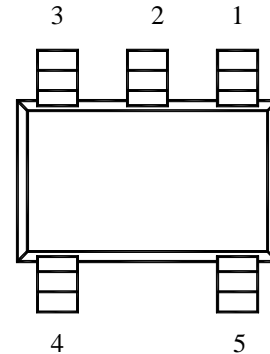

## PIN Configuration

PIN	Function	PIN	Function
1	GND	4	LO
2	GND	5	RF
3	IF		

## Schematic

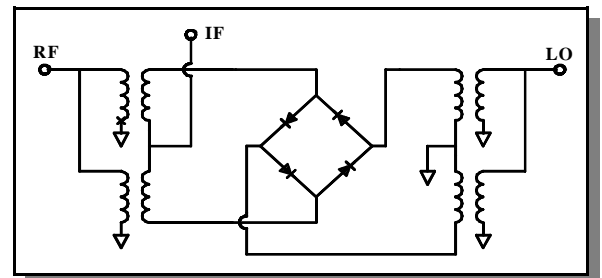

## Electrical Specifications @ + 25 °C

Parameter	Frequency Range	Test Conditions	Units	Min.	Typ.	Max.
Conversion Loss	1550 MHz	LO Drive = +10 dBm	dB		5.5	6.0
	1300-1900 MHz	RF = -10 dBm, IF = 60 MHz	dB		6.0	7.5
L - R Isolation	1550 MHz	LO Drive = +10 dBm	dB		17.0	
	1300-1900 MHz	RF Level = -10 dBm	dB		17.0	
L - I Isolation	1550 MHz	LO Drive = +10 dBm	dB		21.0	
	1300-1900 MHz	RF Level = -10 dBm	dB		22.0	
R - I Isolation	1550 MHz	LO Drive = +10 dBm	dB		16.5	
	1300-1900 MHz	RF Level = -10 dBm	dB		17.0	
LO VSWR	1550 MHz	LO Drive = +10 dBm			1.7:1	
	1300-1900 MHz	RF Level = -10 dBm			2.0:1	
RF VSWR	1550 MHz	LO Drive = +10 dBm			1.3:1	
	1300-1900 MHz	RF Level = -10 dBm			1.6:1	
IF VSWR	DC - 500 MHz	LO Drive = +10 dBm RF Level = -10 dBm			1.5:1	
Input IP3	1550 MHz	LO Drive = +10 dBm	dBm	12.5	15.0	
	1300-1900 MHz	IF = 60 MHz	dBm	12.0	17.0	
Input 1 dB Compression	1550 MHz	LO Drive = +10 dBm	dBm		5.0	
	1300-1900 MHz	IF = 60 MHz	dBm		6.0	
IF 1 dB Bandwidth			MHz	0		500

M/A-COM Inc. and its affiliates reserve the right to make changes to the product(s) or information contained herein without notice. MA-COM makes no warranty, representation or guarantee regarding the suitability of its products for any particular purpose, nor does M/A-COM assume any liability whatsoever arising out of the use or application of any product(s) or information.

Visit [www.macom.com](http://www.macom.com) for additional data sheets and product information.

- North America: Tel. (800) 366-2266
- Asia/Pacific: Tel. +81-44-844-8296, Fax +81-44-844-8298
- Europe: Tel. +44 (1344) 869 595, Fax +44 (1344) 300 020

Typical Performance Curves (LO Drive = +10 dBm, RF = -10 dBm, IF = 60 MHz)

Conversion Loss

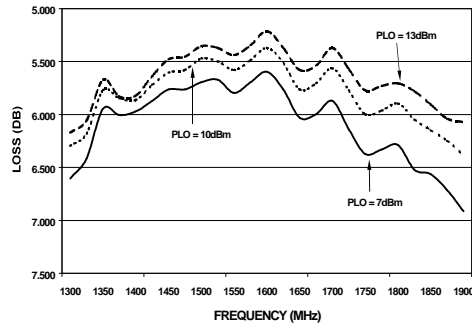

Isolation

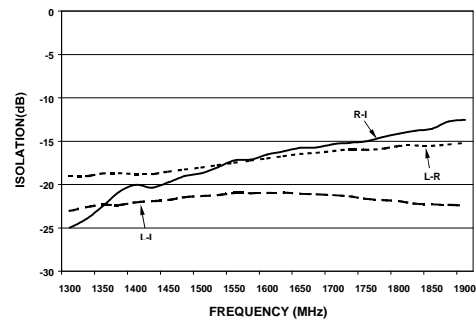

IF VSWR

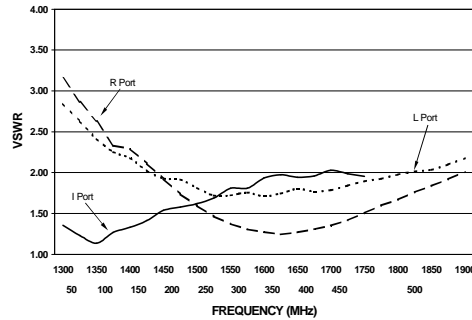

Input IP3 & 1 dB Compression Point

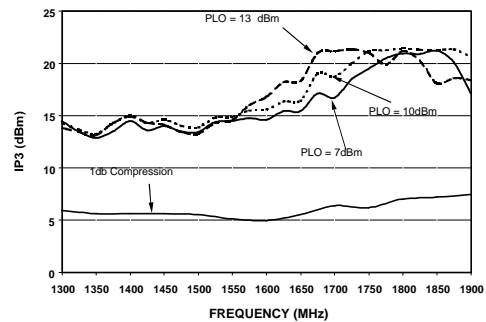

M/A-COM Inc. and its affiliates reserve the right to make changes to the product(s) or information contained herein without notice. MA-COM makes no warranty, representation or guarantee regarding the suitability of its products for any particular purpose, nor does M/A-COM assume any liability whatsoever arising out of the use or application of any product(s) or information.

Visit [www.macom.com](http://www.macom.com) for additional data sheets and product information.

- North America: Tel. (800) 366-2266
- Asia/Pacific: Tel.+81-44-844-8296, Fax +81-44-844-8298
- Europe: Tel. +44 (1344) 869 595, Fax+44 (1344) 300 020

Case Style—SOT-25

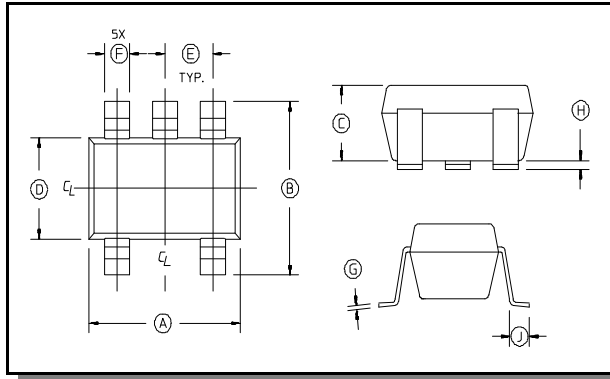

SOT-25 Dimensions

Dim	Inches		Millimeters	
	Min.	Max.	Min.	Max.
A	.106	.122	2.70	3.10
B	.100	.118	2.54	3.00
C	—	.051	—	1.30
D	.063 REF.		1.60 REF.	
E	.032	.043	.80	1.10
F	.014	.020	.35	.50
G	.003	—	.08	—
H	.000	.006	.00	.15
J	.018 REF.		.45 REF.	

Notes: 1. Leads Coplanarity should be 0.003 (0.08) max.

Ordering Information

Part Number	Package
MA4EX180M-1225	Tube
MA4EX180M-1225T	Tape and Reel

M/A-COM Inc. and its affiliates reserve the right to make changes to the product(s) or information contained herein without notice. MA-COM makes no warranty, representation or guarantee regarding the suitability of its products for any particular purpose, nor does M/A-COM assume any liability whatsoever arising out of the use or application of any product(s) or information.

Visit [www.macom.com](http://www.macom.com) for additional data sheets and product information.

- North America: Tel. (800) 366-2266
- Asia/Pacific: Tel.+81-44-844-8296, Fax +81-44-844-8298
- Europe: Tel. +44 (1344) 869 595, Fax+44 (1344) 300 020