

Silicon Double Balanced HMIC™ Mixer, 1700 - 2500 MHz

MA4EX240H-1225

Features

- Low Cost Miniature Plastic Package
- 6.5 dB Typical Conversion Loss at 2100 MHz
- 6.0 dB Typical Conversion Loss at 2400 MHz
- +13 to +17 dBm LO Drive
- HMIC™ Patented Process
- Silicon Low Barrier Schottky Diodes
- DC - 500 MHz IF Bandwidth

Description

M/A-COM's MA4EX240H-1225 is a silicon monolithic 1700-2500 MHz double balanced mixer in a low cost miniature surface mount SOT-25 package. The die uses M/A-COM's unique HMIC™ silicon/glass process to achieve low loss passive elements while retaining the advantages of high barrier silicon Schottky diodes.

Applications

These mixers are well suited for high volume WLAN and cellular applications where small size and repeatability are required. Typical applications include frequency conversion, modulation, and demodulation for receivers and transmitters in both portable cellular and base station applications.

Absolute Maximum Ratings¹

Parameter	Maximum Ratings
Operating Temperature	-40 °C to +85 °C
Storage Temperature	-65 °C to +150 °C
Incident LO Power	+20 dBm
Incident RF Power	+20 dBm

1. Exceeding these limits may cause permanent damage.

Package Outline

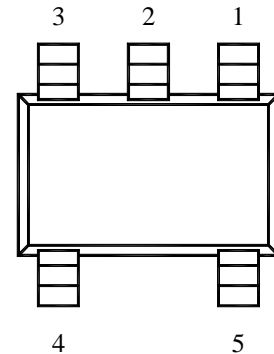

PIN Configuration

PIN	Function	PIN	Function
1	IF	4	LO
2	GND	5	RF
3	GND		

Functional Schematic

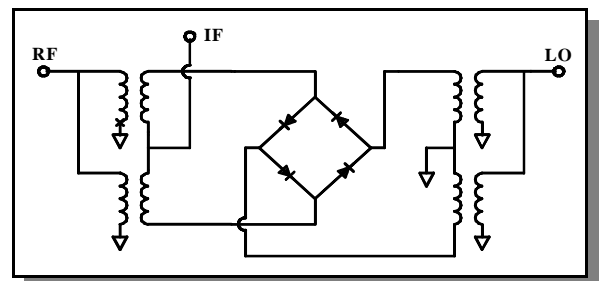

Electrical Specifications: @ + 25 °C

Parameter	Frequency Range	Test Conditions	Units	Min.	Typ.	Max.
Conversion Loss	2100 MHz 1700-2500 MHz	LO Drive = +5 dBm RF = -10 dBm, IF = 60 MHz	dB dB		5.4 6.0	6.0 7.0
L - R Isolation	2100 MHz 1700-2500 MHz	LO Drive = +5 dBm RF Level = -10 dBm	dB dB		17.0 16.0	
L - I Isolation	2100 MHz 1700-2500 MHz	LO Drive = +5 dBm RF Level = -10 dBm	dB dB		21.0 21.0	
R - I Isolation	2100 MHz 1700-2500 MHz	LO Drive = +5 dBm RF Level = -10 dBm	dB dB		13.0 14.0	
RF VSWR	2100 MHz 1700-2500 MHz	LO Drive = +5 dBm RF Level = -10 dBm			1.3:1 1.9:1	
IF VSWR	DC - 400 MHz	LO Drive = +5 dBm RF Level = -10 dBm			1.8:1	
Input IP3	2100 MHz 1700-2500 MHz	LO Drive = +5 dBm IF = 60 MHz	dBm dBm	13.8 13.8	+18.1 +21.0	
Input 1 dB Compression	2100 MHz 1700-2500 MHz	LO Drive = +5 dBm IF = 60 MHz	dBm dBm		+8.5 +8.7	
IF 1 dB Bandwidth			MHz	0		500.0

M/A-COM Inc. and its affiliates reserve the right to make changes to the product(s) or information contained herein without notice. MA-COM makes no warranty, representation or guarantee regarding the suitability of its products for any particular purpose, nor does M/A-COM assume any liability whatsoever arising out of the use or application of any product(s) or information.

Visit www.macom.com for additional data sheets and product information.

- North America: Tel. (800) 366-2266
- Asia/Pacific: Tel.+81-44-844-8296, Fax +81-44-844-8298
- Europe: Tel. +44 (1344) 869 595, Fax+44 (1344) 300 020

tyco / Electronics

M/A-COM

Typical Performance Curves (LO Drive = +15 dBm, RF = -10 dBm, IF = 60 MHz)

Conversion Loss

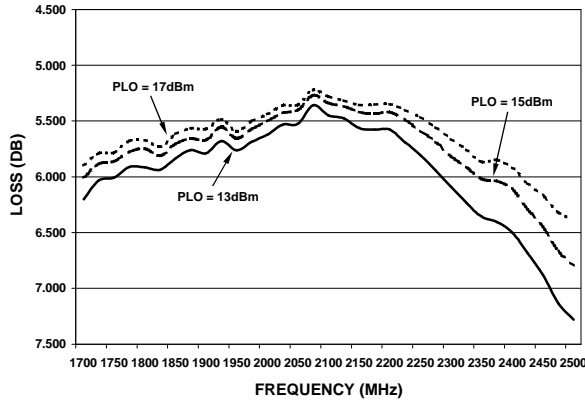

Isolation

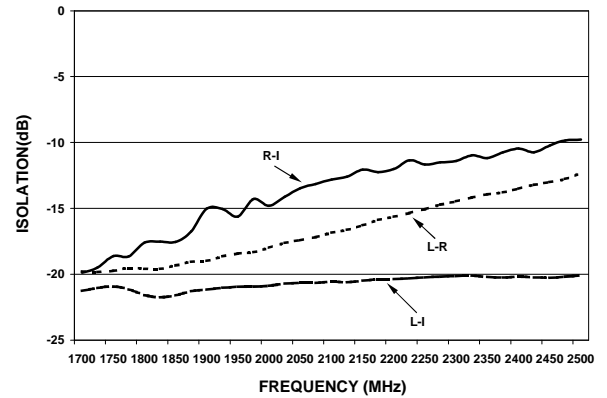

VSWR

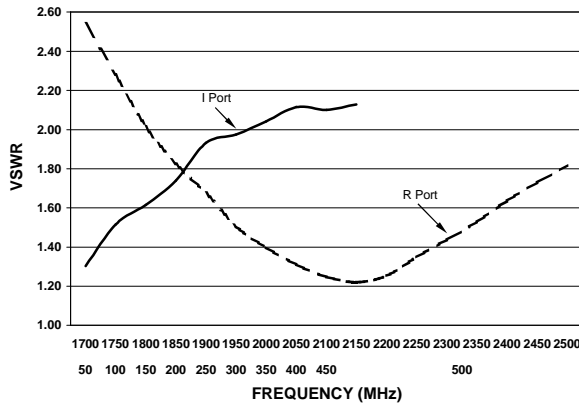

Input IP3 & 1 dB Compression Point

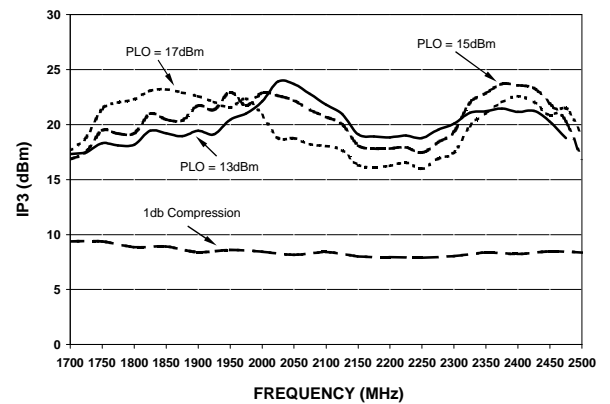

M/A-COM Inc. and its affiliates reserve the right to make changes to the product(s) or information contained herein without notice. MA-COM makes no warranty, representation or guarantee regarding the suitability of its products for any particular purpose, nor does M/A-COM assume any liability whatsoever arising out of the use or application of any product(s) or information.

Visit www.macom.com for additional data sheets and product information.

- North America: Tel. (800) 366-2266
- Asia/Pacific: Tel. +81-44-844-8296, Fax +81-44-844-8298
- Europe: Tel. +44 (1344) 869 595, Fax+44 (1344) 300 020

Case Style - SOT-25

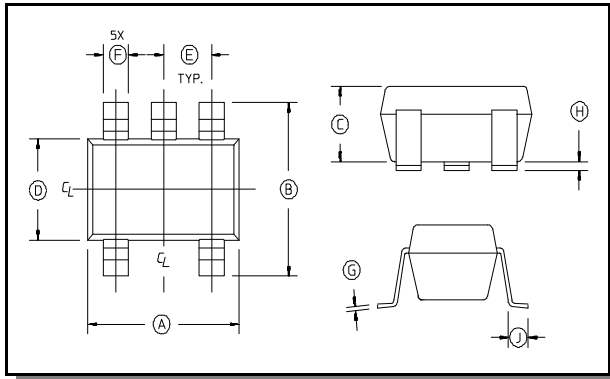

SOT-25 Dimensions

Dim	Inches		Millimeters	
	Min.	Max.	Min.	Max.
A	.106	.122	2.70	3.10
B	.100	.118	2.54	3.00
C	—	.051	—	1.30
D	.063 REF.		1.60 REF.	
E	.032	.043	.80	1.10
F	.014	.020	.35	.50
G	.003	—	.08	—
H	.000	.006	.00	.15
J	.018 REF.		.45 REF.	

Notes: 1. Leads Coplanarity should be 0.003 (0.08) max.

Ordering Information

Part Number	Package
MA4EX240H-1225	Tube
MA4EX240H-1225T	Tape and Reel

M/A-COM Inc. and its affiliates reserve the right to make changes to the product(s) or information contained herein without notice. MA-COM makes no warranty, representation or guarantee regarding the suitability of its products for any particular purpose, nor does M/A-COM assume any liability whatsoever arising out of the use or application of any product(s) or information.

Visit www.macom.com for additional data sheets and product information.

- North America: Tel. (800) 366-2266
- Asia/Pacific: Tel. +81-44-844-8296, Fax +81-44-844-8298
- Europe: Tel. +44 (1344) 869 595, Fax +44 (1344) 300 020