

Silicon Double Balanced HMIC™ Mixer, 1725 - 2125 MHz

MA4EXP190H-1277

Features

- +33 dBm Typical Input IP3
- 8.3 dB Typical Conversion Loss
- +17 to +19 dBm LO Drive
- Fully Balanced Passive Mixer
- NO External Matching required
- Low Cost Miniature Plastic MLP Package

MLP 3mm Package - Circuit Side View



Description

M/A-COM's MA4EXP190H-1277 is a silicon monolithic 1725-2125 MHz, high barrier, double balanced mixer in a low cost miniature surface mount FQFP-N 3 x 3mm Square 16 lead plastic package. The die uses M/A-COM's unique HMIC silicon/glass process to realize low loss passive elements while retaining the advantages of high barrier silicon schottky barrier diodes.

Applications

These mixers are well suited for GSM, DCS, PCS, CDMA and UMTS base station applications where small size and high performance are required. Typical applications include frequency conversion, modulation, and demodulation in wireless receivers and transmitters.

PIN Configuration

PIN	Function	PIN	Function
1	N/C	9	N/C
2	N/C	10	RF
3	LO	11	N/C
4	N/C	12	N/C
5	N/C	13	N/C
6	N/C	14	IF
7	N/C	15	N/C
8	N/C	16	N/C

Ordering Information

Part Number	Package
MA4EXP190H-1277	Tube
MA4EXP190H-1277T	Tape and Reel

Absolute Maximum Ratings¹

Parameter	Maximum Ratings
Operating Temperature	-40 °C to +85 °C
Storage Temperature	-65 °C to +150 °C
Incident LO Power	+20 dBm C.W.
Incident RF Power	+20 dBm C.W.

1. Exceeding these limits may cause permanent damage.

Mixer Schematic

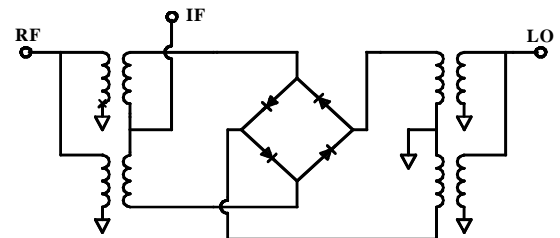

Electrical Specifications: @ + 25 °C

Parameter	Frequency Range	Test Conditions	Units	Min.	Avg.	Max.
Conversion Loss	1925 MHz 1725-2125 MHz	LO Drive = +19 dBm RF = -10 dBm, IF = 60 MHz	dB	- -	8.3 8.4	9.5 9.5
L - R Isolation	1925 MHz 1725-2125 MHz	LO Drive = +17 dBm RF Level = -10 dBm	dB	- -	48.0 48.0	- -
L - I Isolation	1925 MHz 1725-2125 MHz	LO Drive = +17 dBm RF Level = -10 dBm	dB	- -	46.0 44.0	- -
R - I Isolation	1925 MHz 1725-2125 MHz	LO Drive = +17 dBm RF Level = -10 dBm	dB	- -	25.0 25.0	- -
RF VSWR	1925 MHz 1725-2125 MHz	LO Drive = +17 dBm RF Level = -10 dBm	Ratio	- -	1.1:1 1.3:1	- -
IF VSWR	DC - 500 MHz	LO Drive = +17 dBm RF Level = -10 dBm	Ratio	- -	1.6:1	-
Input IP3	2025 MHz 1725-2125 MHz	LO Drive = +19 dBm RF = -10 dBm, IF = 60 MHz	dBm	- -	34.0 33.0	- -
Input 1 dB Compression	1925 MHz 1725-2125 MHz	LO Drive = +17 dBm IF = 60 MHz	dBm	- -	11.3 11.0	- -
IF 1 dB Bandwidth	DC - 400 MHz	LO = 1850 MHz @ +17 dBm	MHz	0	-	400

Typical Performance Curves (LO Drive = +17 dBm, RF = -10 dBm, IF = 60 MHz)

Conversion Loss

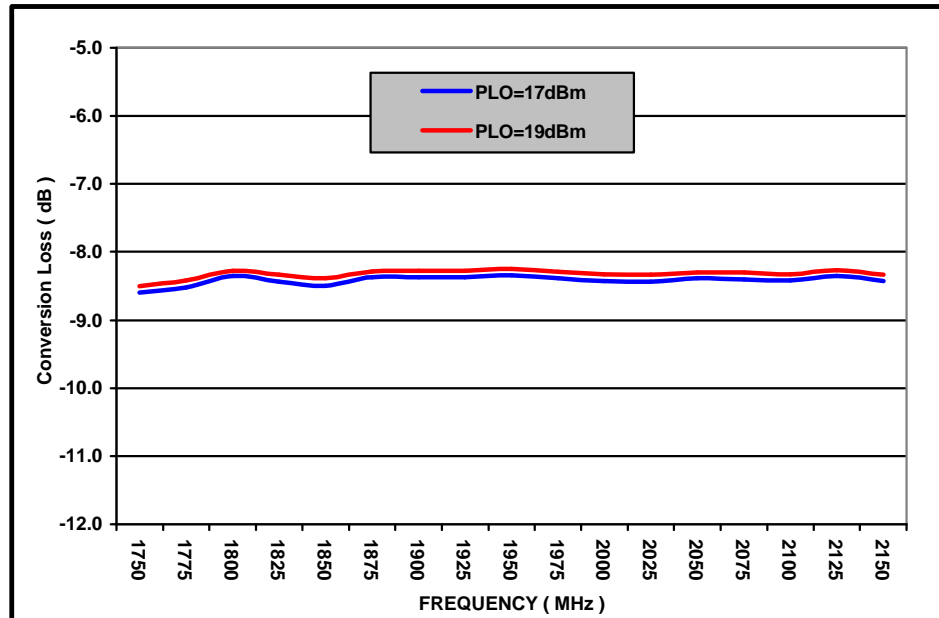

Isolation

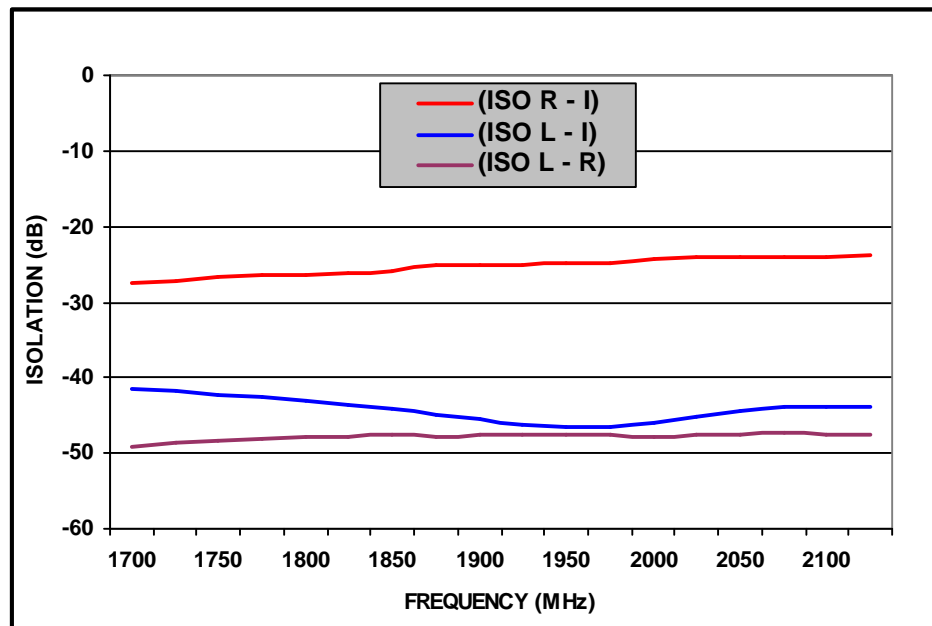

Typical Performance Curves (LO Drive = +17 dBm, RF = -10 dBm, IF = 60 MHz)

RF & IF VSWR

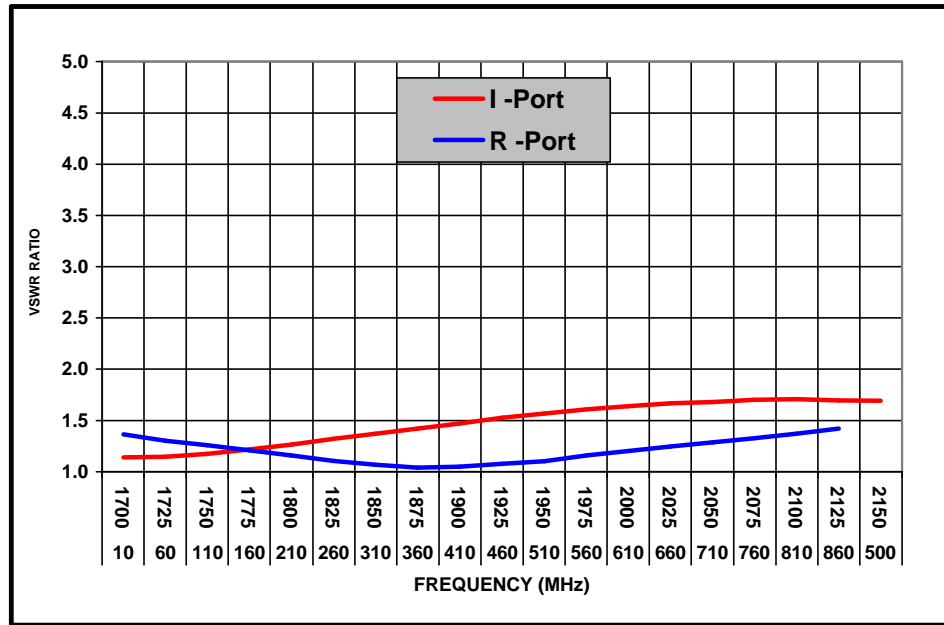

INPUT IP3 & 1 dB Compression Power

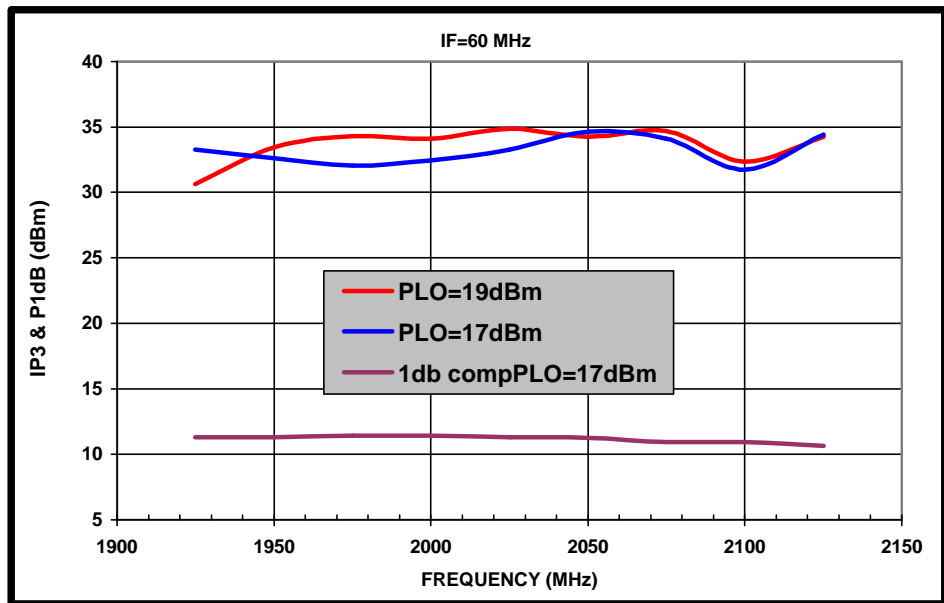

Typical Performance Curves (LO Drive = +19 dBm, RF = -10 dBm, IF = 200 MHz)

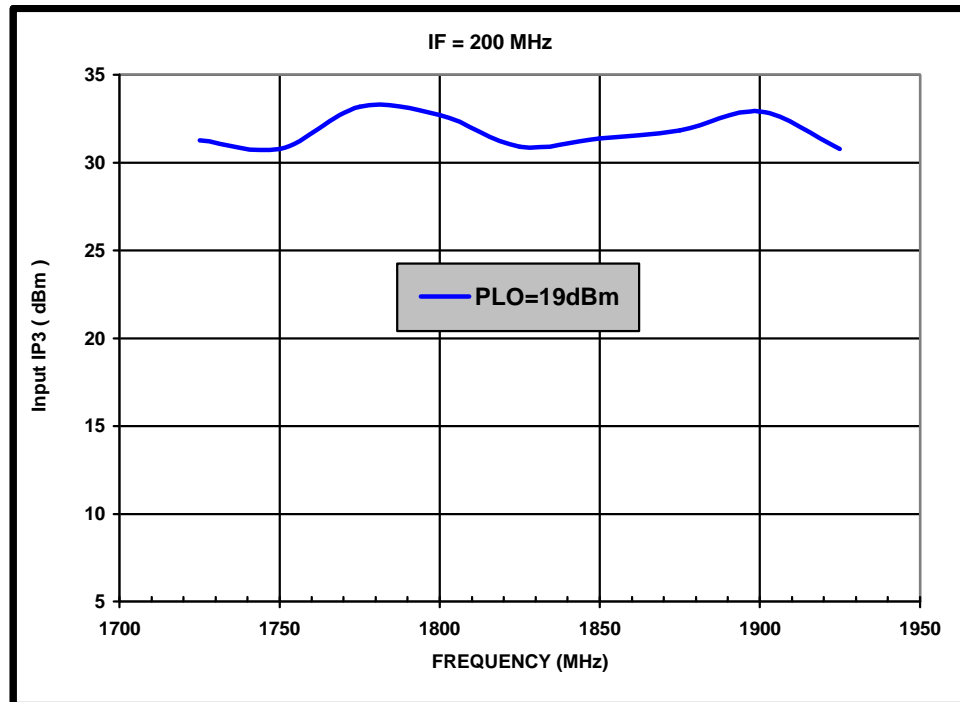
Input IP3

MA4EXP190H-1277 Outline – 3mm FQFP-N 16 Lead Saw Singulated

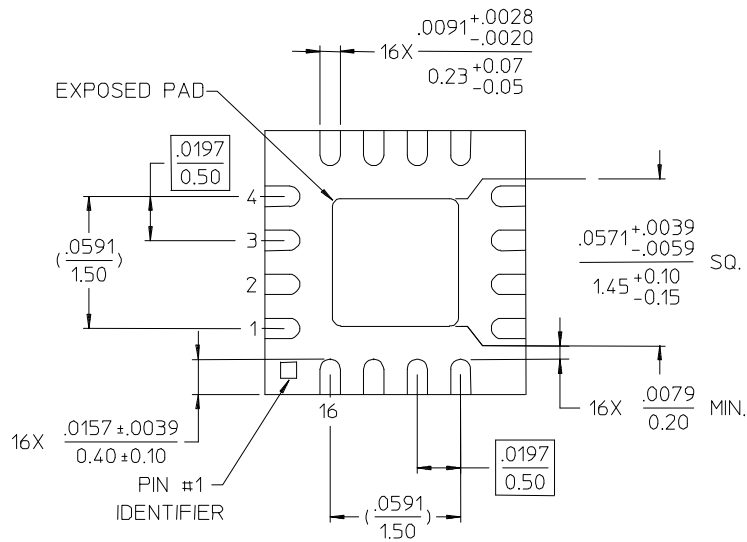
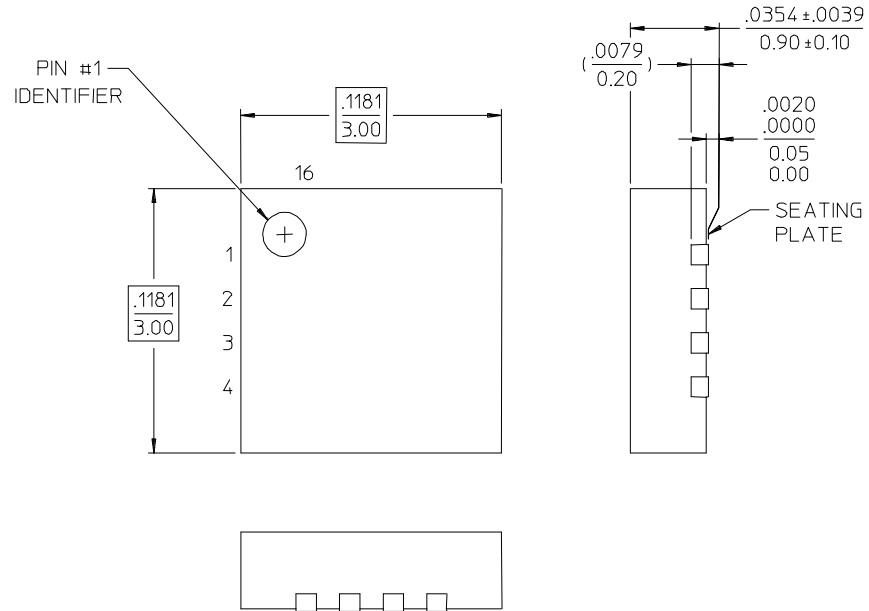

- NOTES: 1. REFER TO JEDEC MO-220, VAR. VBBD-1 FOR ADDITIONAL DIMENSIONAL AND TOLERANCE INFORMATION.
 2. REFER TO S2083 APPLICATION NOTE FOR PCB FOOTPRINT INFORMATION.
 3. ALL DIMENSIONS SHOWN AS INCHES/MM.

M/A-COM Inc. and its affiliates reserve the right to make changes to the product(s) or information contained herein without notice.

Visit www.macom.com for additional data sheets and product information.

- North America: Tel. (800) 366-2266
- Asia/Pacific: Tel. +81-44-844-8296, Fax +81-44-844-8298
- Europe: Tel. +44 (1908) 574 200, Fax +44 (1908) 574 300