

# Silicon Double Balanced HMIC™ Mixer, 850 - 1050 MHz

# MA4EXP950M-1277

## Features

- + 28 dBm Typical Input IP3
- 62dB Typical L-R Isolation
- 8. 2dB Typical Conversion Loss
- + 13 to + 17 dBm LO Drive
- NO External Matching Required
- Low Cost Miniature Plastic MLP Package

## Description

M/A-COM's MA4EXP950M-1277 is a silicon monolithic 850-1050 MHz, Medium barrier, double balanced mixer in a low cost, miniature surface mount FQFP-N 3mm Square, 16 lead plastic package. The die uses M/A-COM's unique HMIC silicon/glass process to realize low loss passive elements while retaining the advantages of medium barrier silicon schottky diodes to produce a compact device.

## Applications

These mixers are well suited for GSM and CDMA Cellular basestation applications where small size and high performance are required. Typical applications include frequency conversion, modulation, and demodulation in wireless receivers and transmitters.

## Ordering Information

Model Number	Package
MA4EXP950M-1277	Tube
MA4EXP950M-1277T	Tape and Reel

## Absolute Maximum Ratings<sup>1</sup>

Parameter	Maximum Ratings
Operating Temperature	-40 °C to +85 °C
Storage Temperature	-65 °C to +150 °C
Incident LO Power	+20 dBm C.W.
Incident RF Power	+20 dBm C.W.

1. Exceeding these limits may cause permanent damage.

## MLP 3mm Package - Circuit Side View

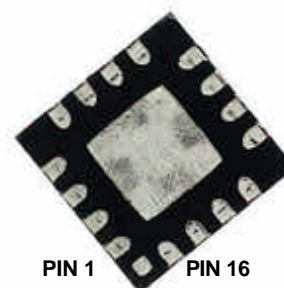

## PIN Configuration (center area is ground)

PIN	Function	PIN	Function
1	N/C	9	N/C
2	N/C	10	RF
3	LO	11	N/C
4	N/C	12	N/C
5	N/C	13	N/C
6	N/C	14	IF
7	N/C	15	N/C
8	N/C	16	N/C

## Mixer Schematic

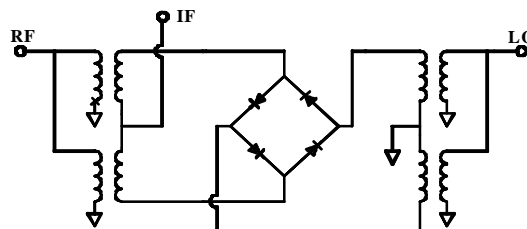

## Electrical Specifications @ + 25 °C

Parameter	Frequency Range	Test Conditions	Units	Min.	Avg.	Max.
Conversion Loss	900 MHz 850-1050 MHz	LO Drive = +15 dBm RF = -10 dBm, IF = 60 MHz	dB	- -	8.0 8.2	9.0 9.1
L - R Isolation	900 MHz 850-1050 MHz	LO Drive = +15 dBm RF Level = -10 dBm	dB	- -	65.0 62.0	- -
L - I Isolation	900 MHz 850-1050 MHz	LO Drive = +15 dBm RF Level = -10 dBm	dB	- -	54.0 50.0	- -
R - I Isolation	900 MHz 850-1050 MHz	LO Drive = +15 dBm RF Level = -10 dBm	dB	- -	30.0 30.0	- -
LO VSWR	900 MHz 850-1050 MHz	LO Drive = +15 dBm RF Level = -10 dBm	Ratio	- -	1.8:1 1.7:1	- -
RF VSWR	900 MHz 850-1050 MHz	LO Drive = +15 dBm RF Level = -10 dBm	Ratio	- -	1.2:1 1.5:1	- -
IF VSWR	DC-400 MHz	LO Drive = +15 dBm RF Level = -10 dBm	Ratio	- -	1.5:1 -	- -
Input IP3	900 MHz 850-1050 MHz	LO Drive = +15 dBm RF = -10 dBm, IF = 60 MHz	dBm	21.5 21.0	28.0 28.0	- -
Input 1 dB Compression	900 MHz 850-1050 MHz	LO Drive = +15 dBm IF = 60 MHz	dBm	- -	8.0 8.1	- -
IF 1 dB Bandwidth	DC-400 MHz	LO = 900 MHz @ +15dBm	MHz	0	-	400

Typical Performance Curves

(LO Drive = +13, +15, +17 dBm, RF = -10 dBm, IF = 60 MHz)

Conversion Loss

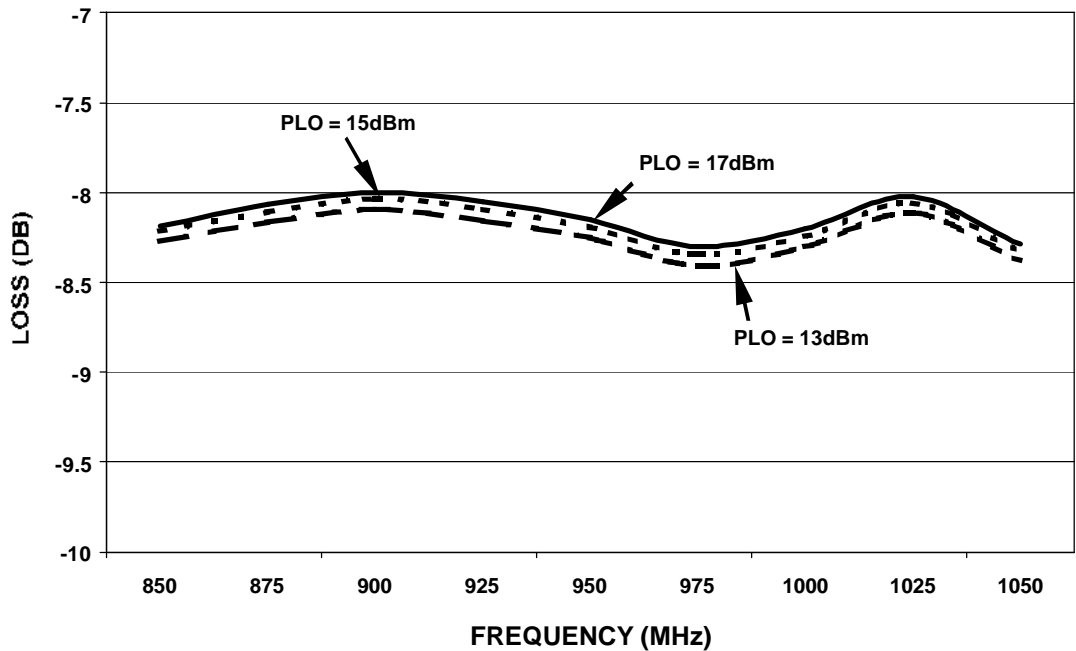

INPUT IP3

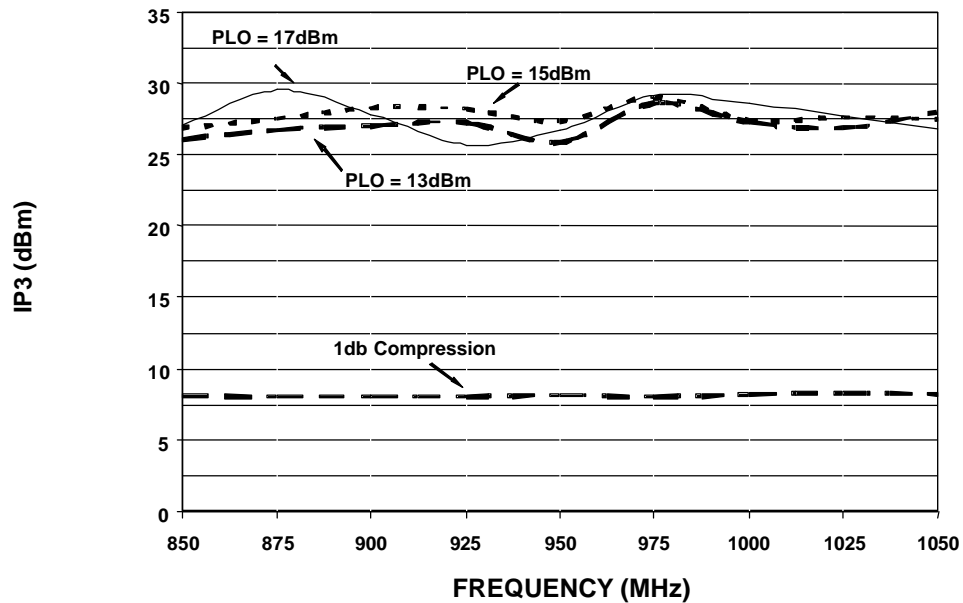

M/A-COM Inc. and its affiliates reserve the right to make changes to the product(s) or information contained herein without notice.

Visit [www.macom.com](http://www.macom.com) for additional data sheets and product information.

- North America: Tel. (800) 366-2266
- Asia/Pacific: Tel.+81-44-844-8296, Fax +81-44-844-8298
- Europe: Tel. +44 (1908) 574 200, Fax+44 (1908) 574 300



Typical Performance Curves

Isolation (LO Drive = +15dbm, RF = -10dBm)

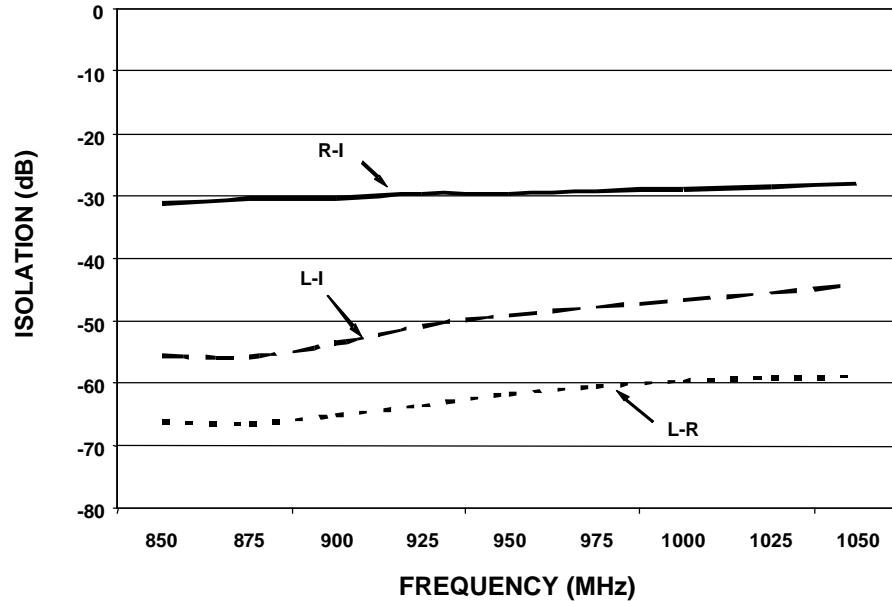

VSWR (LO Drive = +15dbm, RF = -10dBm, IF = -10dBm)

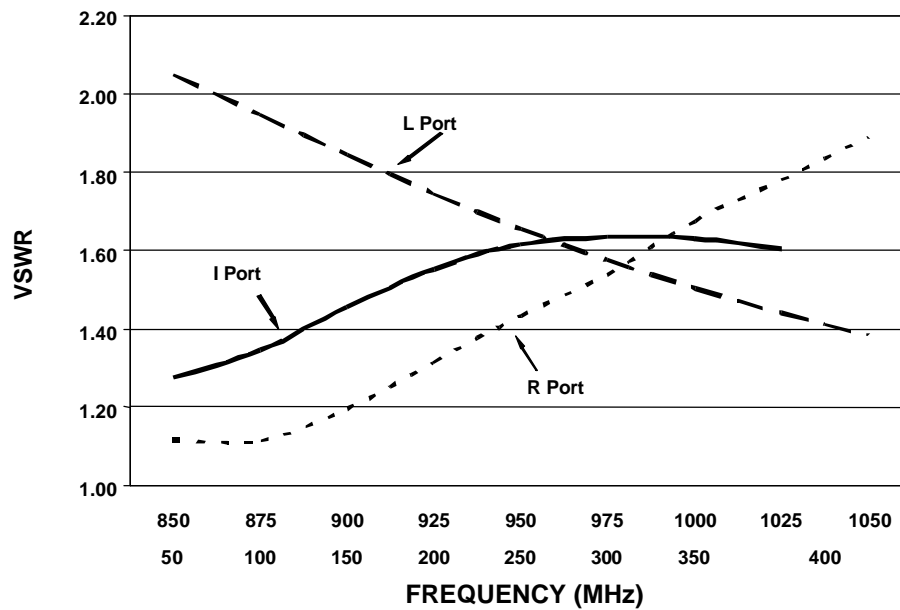

M/A-COM Inc. and its affiliates reserve the right to make changes to the product(s) or information contained herein without notice.

Visit [www.macom.com](http://www.macom.com) for additional data sheets and product information.

- North America: Tel. (800) 366-2266
- Asia/Pacific: Tel.+81-44-844-8296, Fax +81-44-844-8298
- Europe: Tel. +44 (1908) 574 200, Fax+44 (1908) 574 300



MA4EXP190M-1277 Outline - 3mm FQFP-N 16 Lead Saw Singulated

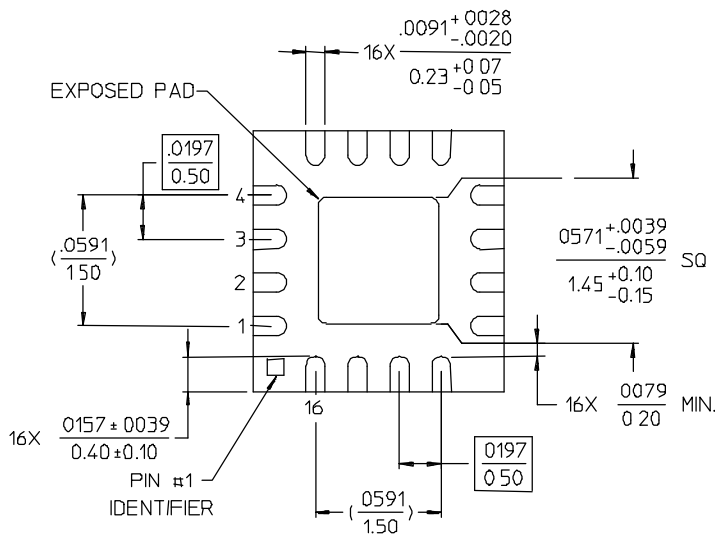
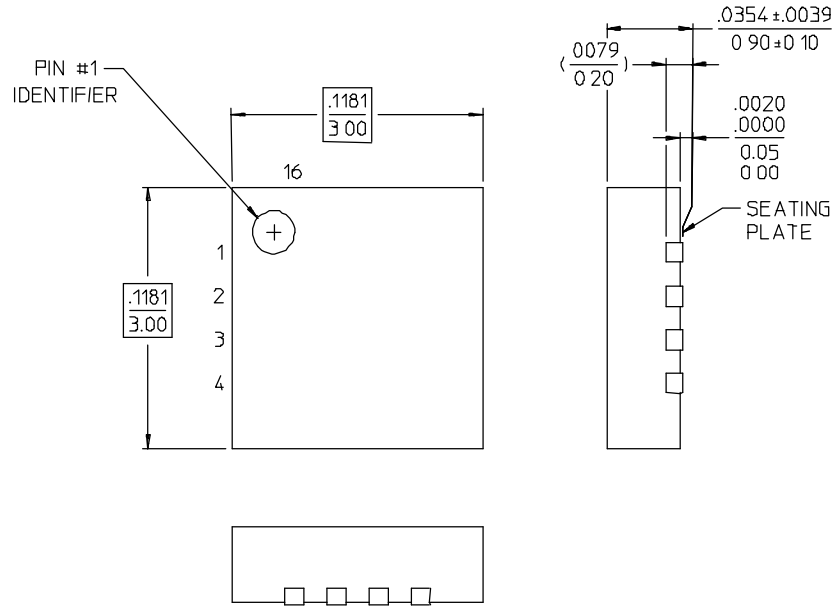

- NOTES: 1. REFERENCED JEDEC MO-220, VAR. VBBD-1 FOR ADDITIONAL DIMENSIONAL AND TOLERANCE INFORMATION.  
 2. REFERENCED S2083 APPLICATION NOTE FOR PCB FOOTPRINT INFORMATION  
 3. ALL DIMENSIONS SHOWN AS INCHES/MM

M/A-COM Inc. and its affiliates reserve the right to make changes to the product(s) or information contained herein without notice.

Visit [www.macom.com](http://www.macom.com) for additional data sheets and product information.

- North America: Tel. (800) 366-2266
- Asia/Pacific: Tel. +81-44-844-8296, Fax +81-44-844-8298
- Europe: Tel. +44 (1908) 574 200, Fax +44 (1908) 574 300