

SURMOUNT™ PIN Diodes
MA4SPS421, MA4SPS422

MA4SPS420 Series
V2

Features

- Surface Mount 100 µm I-Region Length Device
- No Wirebonds Required
- Rugged Silicon-Glass Construction
- Silicon Nitride Passivation
- Polymer Scratch Protection
- Low Parasitic Capacitance and Inductance
- Higher Average and Peak Power Handling

Description and Applications

This device is a Silicon-Glass PIN diode chip fabricated with M/A-COM's patented HMIC™ process. This device features two silicon pedestals embedded in a low loss, low dispersion glass. The diode is formed on the top of one pedestal and connections to the backside of the device are facilitated by making the pedestal sidewalls electrically conductive. Selective backside metallization is applied producing a surface mount device. This Vertical Topology provides for Exceptional Heat Transfer. The topside is fully encapsulated with silicon nitride and has an additional polymer layer for scratch and impact protection. These protective coatings prevent damage to the junction and the anode air-bridge during handling and assembly.

These packageless devices are suitable for usage in Moderate Incident Power (10 W C.W.) or Higher Incident Peak Power (500 W) Series, Shunt, or Series-Shunt Switches. Smaller Parasitic Inductance, 0.1to 0.2 nH, and Excellent RC Constant (0.45 pS), make the devices ideal for Higher Frequency Switch Elements compared to their Plastic Device Counterparts.

Dimensions

Dim	Inches		Millimeters	
	Min.	Max.	Min.	Max.
A	0.040	0.042	1.025	1.075
B	0.021	0.023	0.525	0.575
C	0.004	0.008	0.102	0.203
D	0.013	0.015	0.325	0.375
E	0.011	0.013	0.275	0.325
F	0.013	0.015	0.325	0.375
G	0.019	0.021	0.475	0.525

Absolute Maximum Ratings¹

@ TA = +25 °C (unless otherwise specified)

Parameter	Absolute Maximum
Forward Current	250 mA
Reverse Voltage	1-200 V I
Operating Temperature	-55 °C to +125 °C
Storage Temperature	-55 °C to +150 °C
Junction Temperature	+175 °C
Dissipated Power (RF & DC)	1.8 W
Mounting Temperature	+235 °C for 10 seconds

1. Operation of this device above any one of these parameters may cause permanent damage.

Case Style ODS-1294
(MA4SPS421)

Case Style ODS-1295
(MA4SPS422)

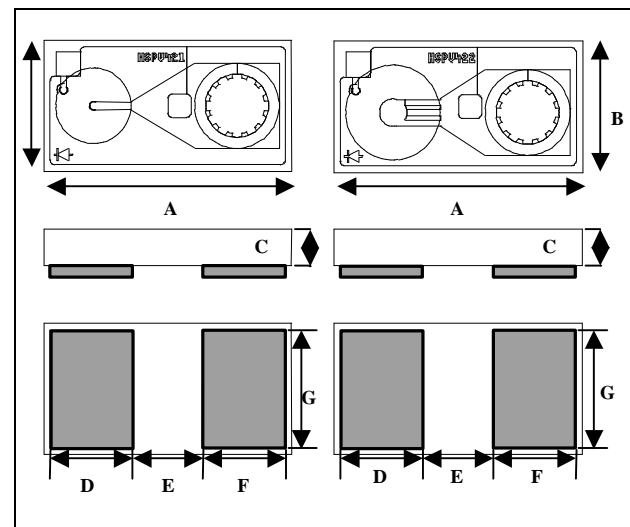

Bottom Side Contacts are Circuit Side

1. Backside metal: 0.1 microns thick.
2. Shaded Areas Indicate Backside Ohmic Gold Contacts.
3. Both Devices have Same Outline Dimensions (A to G).

**SURMOUNT™ PIN Diodes
MA4SPS421, MA4SPS422**

**MA4SPS420 Series
V2**

Electrical Specifications @ + 25 °C

Parameter	Symbol	Conditions	Units	Min.	Typ.	Max.	Min.	Typ.	Max
				MA4SPS421			MA4SPS422		
Capacitance	C _T	0 V, 1 MHz ¹	pF		0.130	0.175		0.340	0.500
Capacitance	C _T	0 V, 1 GHz ^{1,3}	pF		.08			0.14	
Capacitance	C _T	-40 Volts, 1 MHz ¹	pF		0.090	0.125		0.180	0.300
Capacitance	C _T	-40 Volts, 1 GHz ^{1,3}	pF		.07			0.13	
Resistance	R _S	+10 mA, 1 GHz ^{2,3}	Ω		6.2			3.1	
Forward Voltage	V _F	+10 mA	V		0.900	0.950		0.840	0.900
Reverse Leakage Current	I _R	I -200 V I	μA			I -10 I			I -10 I
Input Third Order Intercept Point	IIP3	F 1 = 1000 MHz F 2 = 1010 MHz Input Power = +10 dBm I bias = +10 mA	dBm		+50			+50	
C.W. Thermal Resistance	R _{θJL}	I _H = 0.5 A, I _L = 10 mA	°C/W		80			70	
Minority Carrier Lifetime	T _L	+10 mA / -6 mA (50% - 90% V)	μs		5			10	

1. Total capacitance, C_T, is equivalent to the sum of Junction Capacitance ,C_j, and Parasitic Capacitance, C_{par}.
2. Series resistance R_s is equivalent to the total diode resistance : R_s = R_j (Junction Resistance) + R_c (Ohmic Resistance)
3. R_s and C_T are measured on an HP4291A Impedance Analyzer with die mounted in an ODS-186 package with Sn 60 / Pb 40 solder.
4. Steady-state R_{θJL} measured with die mounted in an ODS-186 package with Sn 60 / Pb 40 solder.

SURMOUNT™ PIN Diodes
MA4SPS421, MA4SPS422**MA4SPS420 Series**
V2**Handling**

All semiconductor chips should be handled with care to avoid damage or contamination from perspiration and skin oils. The use of plastic tipped tweezers or vacuum pickups is strongly recommended for individual components. Bulk handling should insure that abrasion and mechanical shock are minimized.

Bonding

Attachment to a circuit board is made simple through the use of surface mount technology. Mounting pads are conveniently located on the bottom surface of these devices and are removed from the active junction locations. These devices are well suited for solder attachment onto hard and soft substrates. The use of 80 Au / 20 Sn or Sn 60 / Pb 40 solder is recommended. Conductive silver epoxy for die attachment may also be used for lower incident power (<1 W average incident power) applications.

When soldering these devices to a hard substrate, hot gas die bonding is preferred. We re-commend utilizing a vacuum tip and force of 60 to 100 grams applied normal to the top surface of the device. When soldering to soft substrates, it is recommended to use a lead-tin interface at the circuit board mounting pads. Position the die so that its mounting pads are aligned with the circuit board mounting pads and reflow the solder by heating the circuit trace near the mounting pad while applying 60 to 100 grams of force perpendicular to the top surface of the die. The solder joint must Not be made one at a time, creating un-equal heat flow and thermal stress. Solder reflow should Not be performed by causing heat to flow through the top surface of the die. Since the HMIC glass is transparent, the edges of the mounting pads closest to each other can be visually inspected through the die after attach is completed.

A typical profile for a Sn 60/ Pb 40 Soldering process is provided in [Application Note, " M538 "](#) , [" Surface Mounting Instructions "](#) on the MA-COM website www.macom.com.

**SURMOUNT™ PIN Diodes
MA4SPS421, MA4SPS422**

**MA4SPS420 Series
V2**

MA4SPS420 Typical Performance Curves @ +25 °C

Rs vs. Current (@ 100MHz & 1GHz)
MA4SPS421

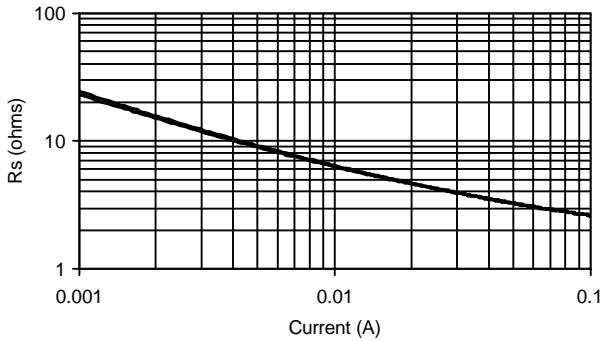

Rs vs. Current (@ 100MHz & 1GHz)
MA4SPS422

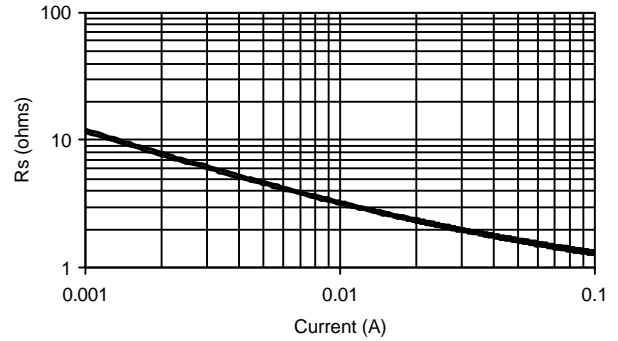

Ct vs Voltage (@ 100MHz & 1GHz)
MA4SPS421

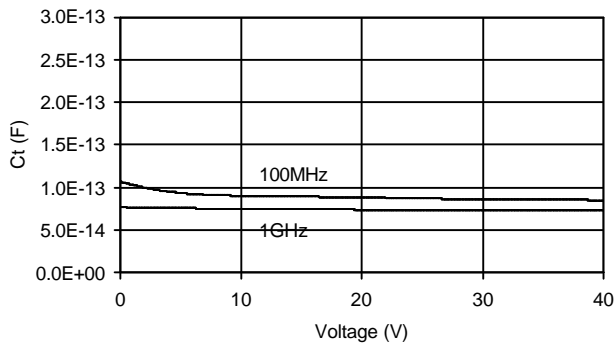

Ct vs Voltage (@ 100MHz & 1GHz)
MA4SPS422

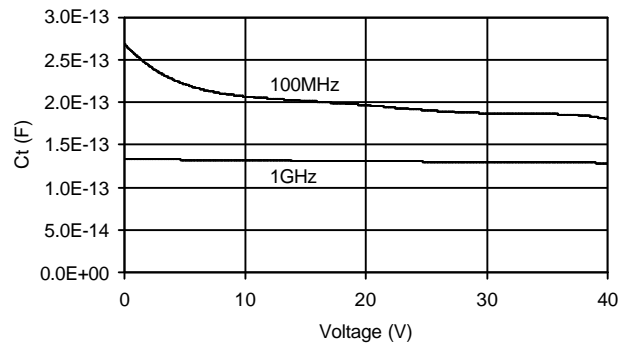

Rp vs Voltage (@ 100MHz & 1GHz)
MA4SPS421

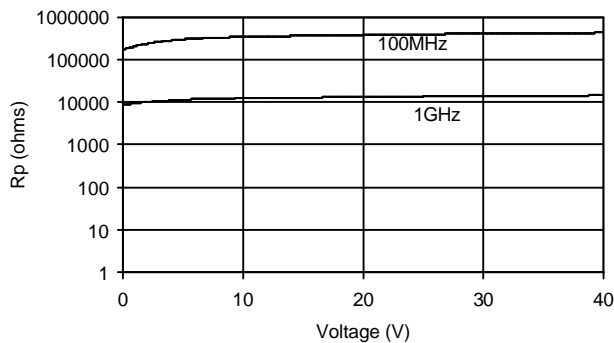

Rp vs Voltage (@ 100MHz & 1GHz)
MA4SPS422

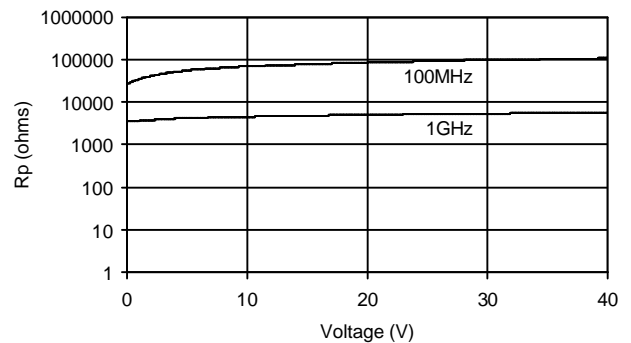

**SURMOUNT™ PIN Diodes
MA4SPS421, MA4SPS422**

**MA4SPS420 Series
V2**

MA4SPS420 Typical Performance Curves @ +25 °C

Ct vs Frequency (@ 0, 5 & 40V)
MA4SPS421

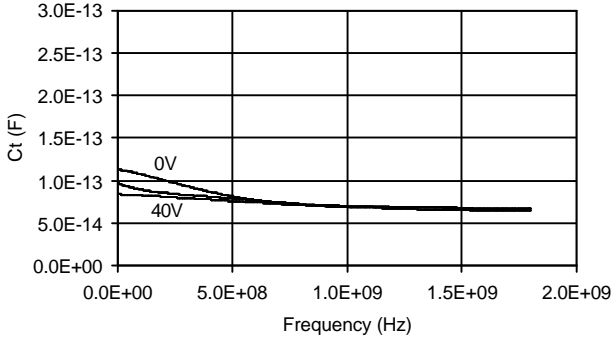

Ct vs Frequency (@ 0, 5 & 40V)
MA4SPS422

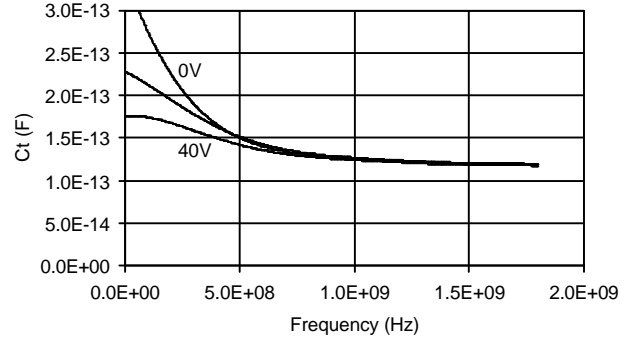

Ls vs Frequency (@ 10mA & 100mA)
MA4SPS421

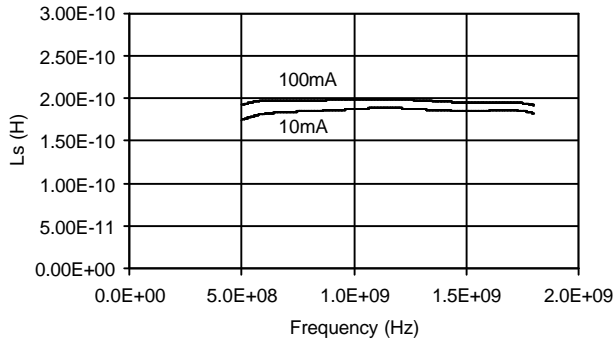

Ls vs Frequency (@ 10mA & 100mA)
MA4SPS422

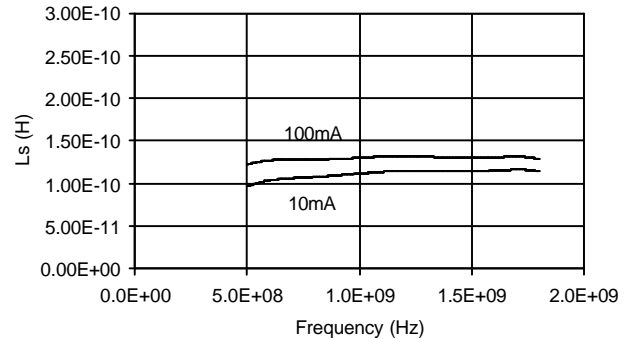

Rs vs Frequency (@ 10mA & 100mA)
MA4SPS421

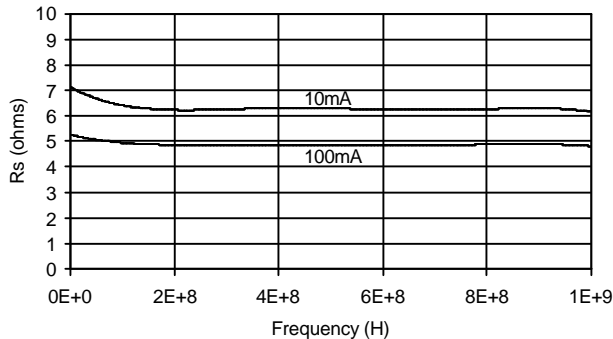

Rs vs Frequency (@ 10mA & 100mA)
MA4SPS422

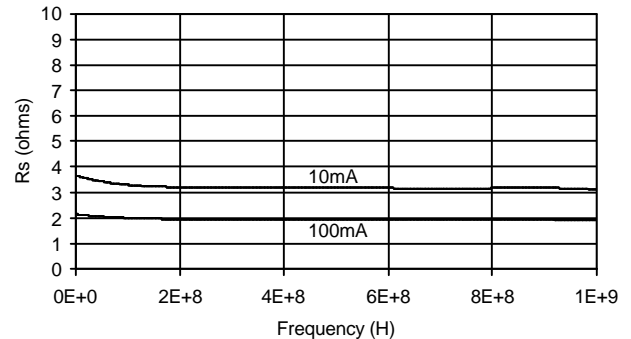

MA4SPS421 SPICE Model

PinDiodeModel	wBv=260 V
NLPINM1	wPmax=1.6 W
Is=1.0E-14 A	Ffe=1.0
Vi=0.0 V	
Un=900 cm ² /V-sec	
Wi=100 um	
Rr=11 K Ohm	
Cmin=0.06 pF	
Tau= 5 usec	
Rs=0.1 Ohm	
Cj0=0.07 pF	
Vj=0.7 V	
M=0.5	
Fc=0.5	
Imax=3.1 E+8 A/m ²	
Kf=0.0	
Af=1.0	

MA4SPS421 Schematic

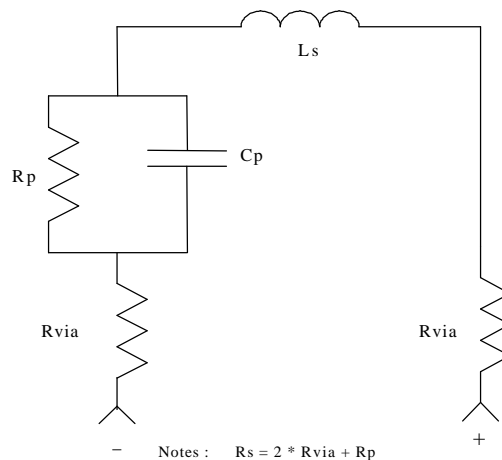

MA4SPS422 SPICE Model

PinDiodeModel wBv=340 V
 NLPINM1 wPmax=1.8 W
 Is=1.0E-14 A Ffe=1.0
 Vi=0.0 V
 Un=900 cm²/V-sec
 Wi=100 um
 Rr=9 K Ohm
 Cmin=0.12 pF
 Tau= 10 usec
 Rs=0.1 Ohm
 Cj0=0.13 pF
 Vj=0.7 V
 M=0.5
 Fc=0.5
 Imax=7.8 E+7 A/m²
 Kf=0.0
 Af=1.0

MA4SPS422 Schematic

