

Surface Mount Monolithic PIN Diode Chip

V 1.00

MA4SPS552

Features

- Surface Mount Device
- No Wirebonds Required
- Rugged Silicon-Glass Construction
- Silicon Nitride Passivation
- Polymer Scratch Protection
- Low Parasitic Capacitance and Inductance
- High Power Handling (Efficient Heatsinking)

Description

This device is a silicon-glass PIN diode chip fabricated with M/A-COM's patented HMIC process. This device features two silicon pedestals embedded in a low loss glass. The diode is formed on the top of one pedestal and connections to the backside of the device are facilitated by making the pedestal sidewalls conductive. Selective backside metalization is applied producing a surface mount device. The topside is fully encapsulated with silicon nitride and has an additional polymer layer for scratch protection. These protective coatings prevent damage to the junction and the anode air-bridge during handling and assembly.

Applications

These packageless devices are suitable for usage in moderate incident power (5 W C.W.) or higher incident peak power (200 W) series, shunt, or series-shunt switches. Small parasitic inductance, 0.7 nH, and excellent RC time constant, 0.20 pS, make the devices ideal for wireless TR switch and accessory switch circuits, where higher P_{1dB} and IP_3 values are required.

These diodes can also be used in π , T, tapered resistance, and switched-pad attenuator control circuits for 50 Ω or 75 Ω systems.

Absolute Maximum Ratings¹

@ $T_A = +25^\circ\text{C}$ (unless otherwise specified)

Parameter	Absolute Maximum
Forward Current	100 mA
Reverse Voltage	-200 V
Operating Temperature	-65 °C to +150 °C
Storage Temperature	-65 °C to +150 °C
Junction Temperature	+175 °C
Dissipated RF & DC Power	1 W
Mounting Temperature	+235 °C for 10 seconds

1. Exceeding these limits may cause permanent damage.

Case Style ODS-1281

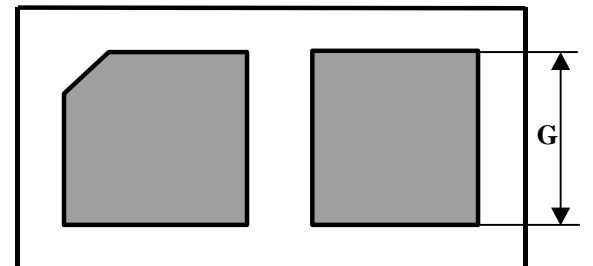
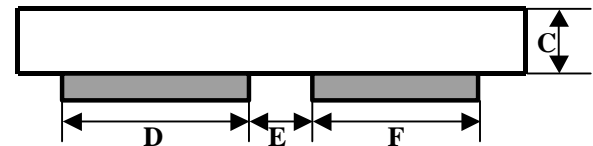
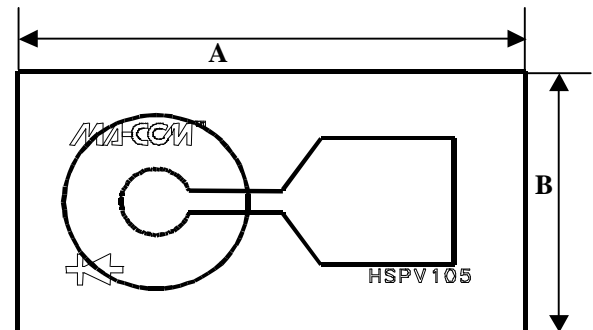

Dim	Inches		Millimeters	
	Min.	Max.	Min.	Max.
A	0.0207	0.0226	0.525	0.575
B	0.0108	0.0128	0.275	0.325
C	0.0040	0.0080	0.102	0.203
D	0.0069	0.0089	0.175	0.225
E	0.0018	0.0037	0.045	0.095
F	0.0061	0.0081	0.155	0.205
G	0.0069	0.0089	0.175	0.225

1. Backside metal: 0.1 micron thk.
2. Hatched areas indicate bond pads.

Electrical Specifications: @ +25 °C

Symbol	Parameter	Conditions	Units	Min.	Typ.	Max.
C _T	Total Capacitance	-40 V, 1 MHz	pF		0.08	0.14
C _T	Total Capacitance	-40 V, 1 GHz	pF		0.06	
R _S	Series Resistance	100 mA, 100 MHz	Ω		1.7	
R _S	Series Resistance	20 mA, 100 MHz	Ω		2.4	
V _F	Forward Voltage	100 mA	V		1.00	1.25
V _F	Forward Voltage	10 mA	V		0.86	1.00
V _R	Reverse Voltage	-10 μA	V	-200	-275	
I _R	Reverse Leakage Current	-40 V	nA		-10	
R _{θJL}	Thermal Resistance	Steady State	°C/W		30	
T _L	Minority Carrier Lifetime	(50% - 90% V) +10 mA / -6 mA	μs		2.5	

Handling Procedures

All semiconductor chips should be handled with care to avoid damage or contamination from perspiration and skin oils. The use of plastic tipped tweezers or vacuum pickups is strongly recommended for individual components. Bulk handling should insure that abrasion and mechanical shock are minimized.

Bonding Techniques

Attachment to a circuit board is made simple through the use of surface mount technology. Mounting pads are conveniently located on the bottom surface of these diodes and are removed from the active junction locations. These devices are well suited for solder attachment onto hard and soft substrates. The use of 80/20 Au/Sn and 60/40 Sn/Pb solder is recommended, with an equal temperature profile across the contacts. Conductive epoxy paste for attachment may also be used.

When soldering these devices to a hard substrate, hot gas die bonding is preferred. We recommend utilizing a vacuum tip and a force of 60 to 100 grams applied normal to the top surface of the device. When soldering to soft substrates, it is recommended to use a lead-tin interface at the circuit board mounting pads. Position the die so that its mounting pads are aligned with the circuit board's mounting pads and reflow the solder by heating the circuit trace near the mounting pad while applying 60 to 100 grams of force perpendicular to the top surface of the die.

Since the HMIC™ glass is transparent, the edges of the mounting pads closest to each other can be visually inspected through the die after attach is completed.

Capacitance vs Frequency

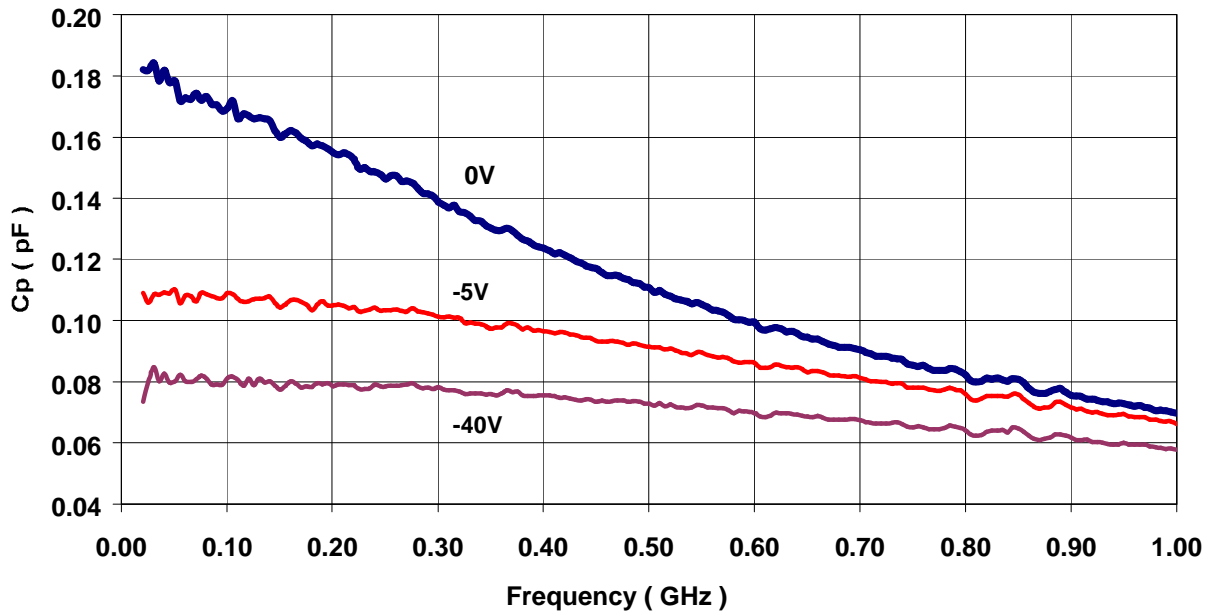

Capacitance vs Voltage

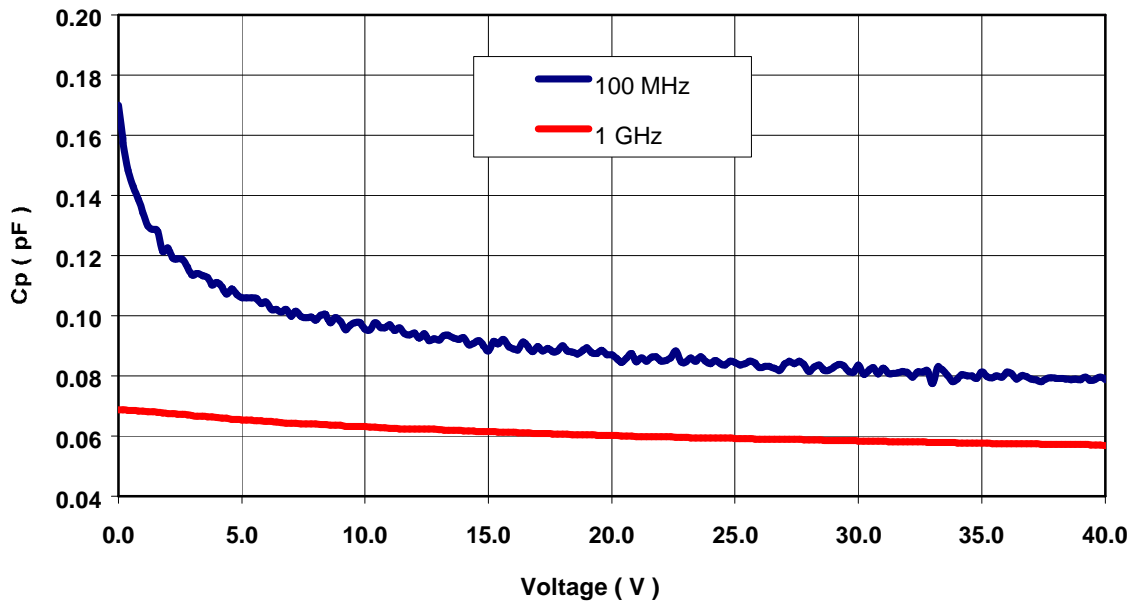

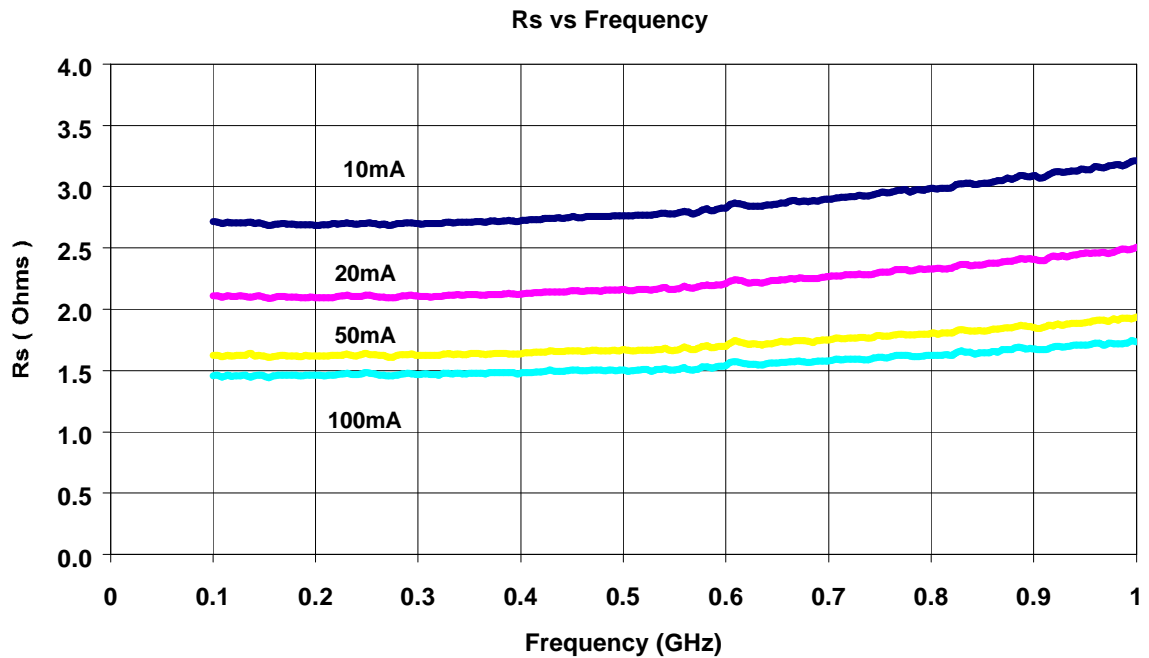
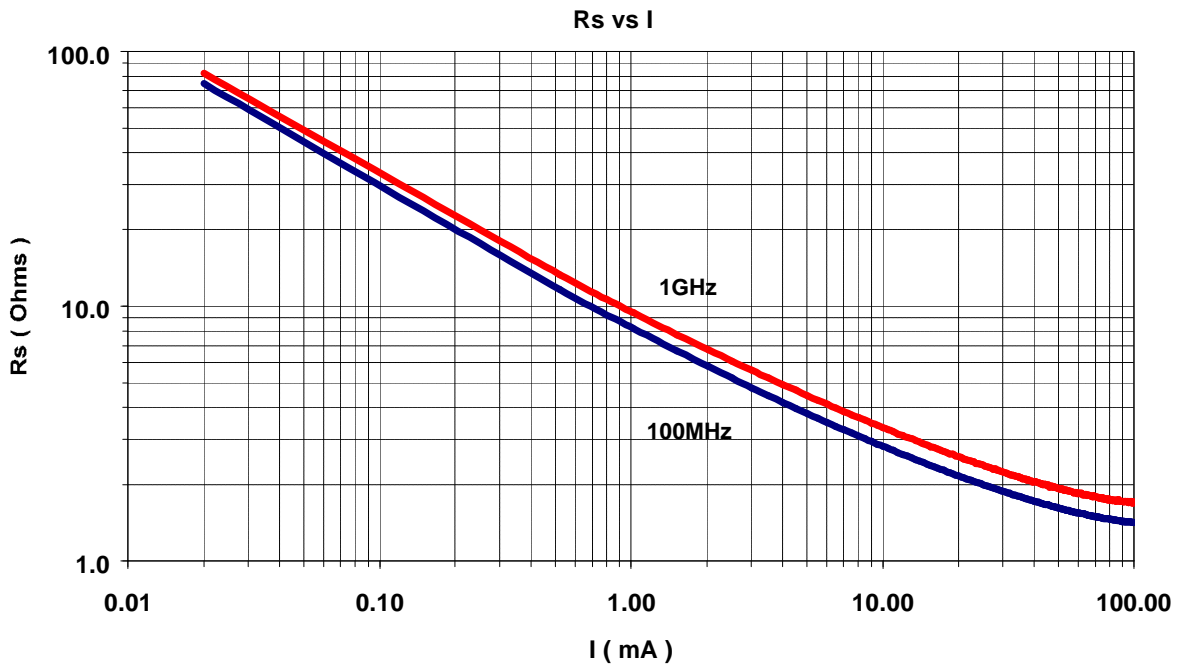

M/A-COM Inc. and its affiliates reserve the right to make changes to the product(s) or information contained herein without notice.

Visit www.macom.com for additional data sheets and product information.

- North America: Tel. (800) 366-2266
- Asia/Pacific: Tel.+81-44-844-8296, Fax +81-44-844-8298
- Europe: Tel. +44 (1908) 574 200, Fax+44 (1908) 574 300

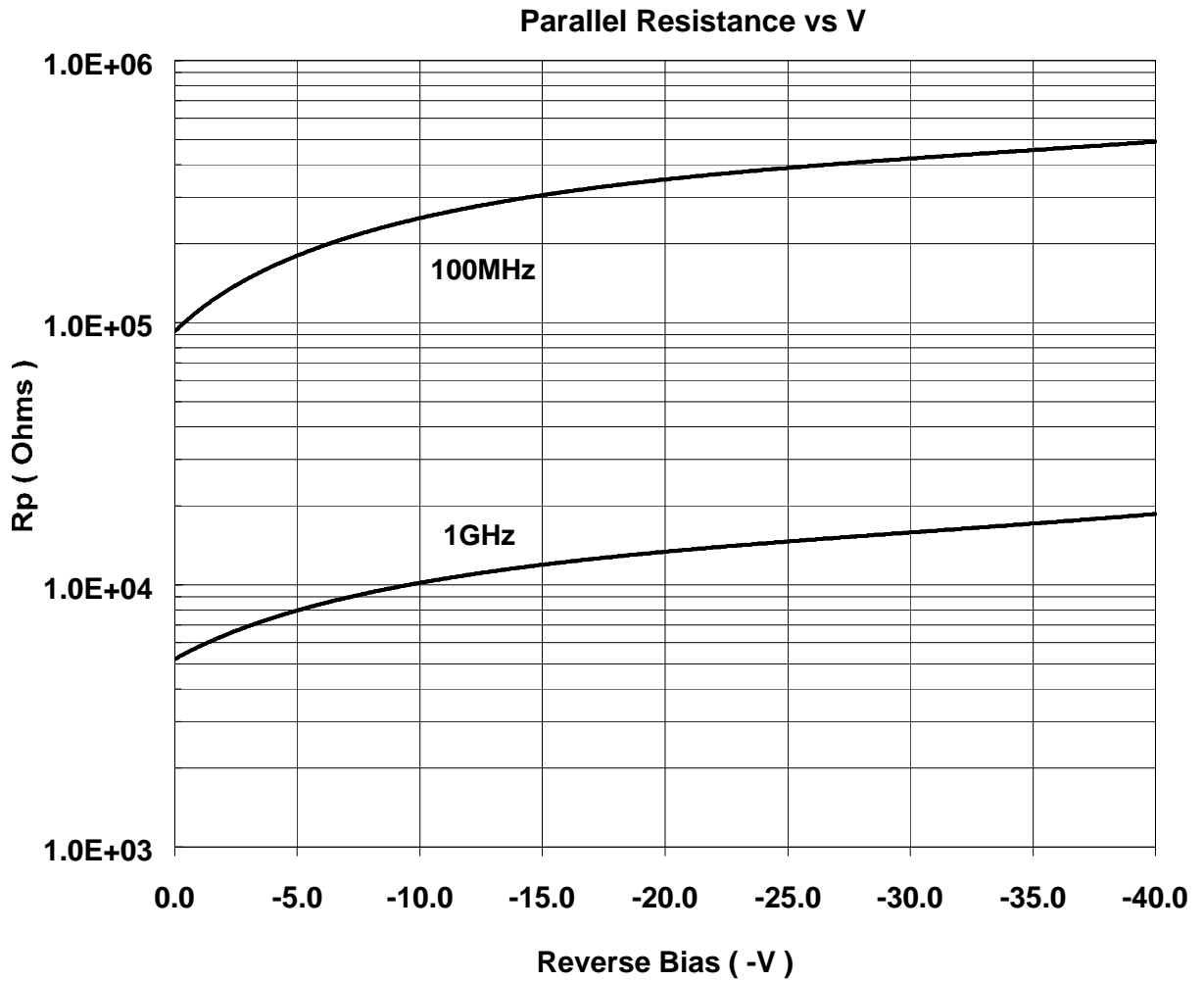

SURMOUNT PIN Diode Model

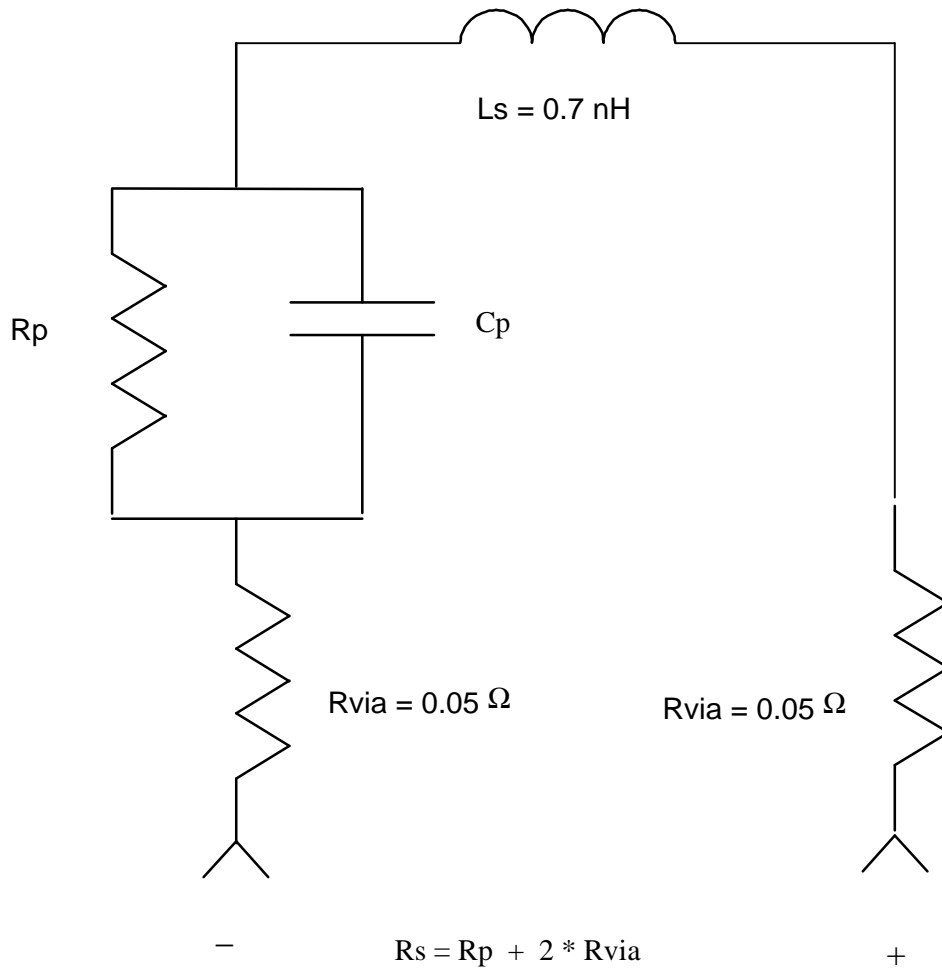

Ordering Information

Part Number	Package
MA4SPS552	Die in Carrier
MA4SPS552-T	Tape/Reel
MA4SPS552-W	Wafer on Frame