



Surface Mount Hyperabrupt Varactors



Features

- Surface Mount Packages
- High Quality Factor
- Capacitance Ratio to 9.5:1
- Tape and Reel Packaging Available
- SPC Monitored Ion Implantation for Excellent C-V Repeatability
- Singles and Common Cathode Pairs

Description

M/A-COM's MA4ST400 series are ion-implanted, hyperabrupt junction, silicon tuning varactors in the SOT-23 surface mount package. These thermal oxide passivated diodes feature high capacitance ratio and quality factor. They are well suited for octave bandwidth tuning in the HF to UHF frequency bands. The standard capacitance tolerance is $\pm 10\%$, with tighter tolerances available. Capacitance matching at one or more bias voltages is also available.

Applications

The MA4ST400 series tuning varactors are useful for octave bandwidth tuning applications in the HF through UHF ranges. Applications include VCOs and voltage tuned filters in radios, cable TV tuners and test instruments where low cost and excellent lot-to-lot repeatability are critical. Linear tuning performance is available from 3 to 8 volts.

Ordering Information

The model number indicated is for a single varactor. When ordering diodes in common cathode pairs add suffix "CK." For example, MA4ST401CK specifies model number MA4ST401 in common cathode pairs. To order parts on tape and reel add suffix "T" to the end of the part number. i.e., MA4ST401CK-T.

SOT-23

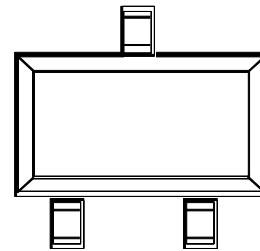

Configurations

TOP VIEW

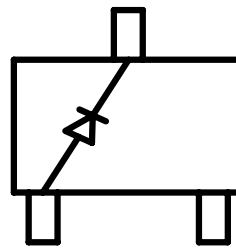

Single

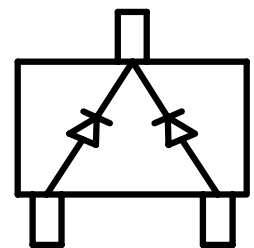

Double

Absolute Maximum Rating @ 25°C

Parameter	Absolute Maximum
Reverse Voltage	22 Volts
Forward Current	50 mA
Total Power Dissipation ¹	250 mW
Junction Operating Temp.	-55°C to +125°C
Storage Temperature	-55°C to +125°C

1. At 25°C case temperature. Derate linearly to zero at 150°C.

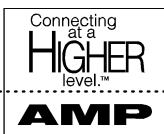

Typical Performance Curves

NOMINAL CHANGE in CAPACITANCE with TEMPERATURE

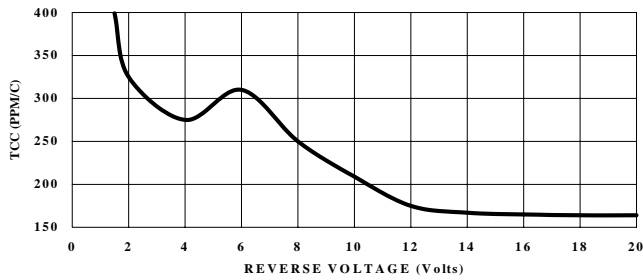

TOTAL CAPACITANCE (pF) vs REVERSE VOLTAGE

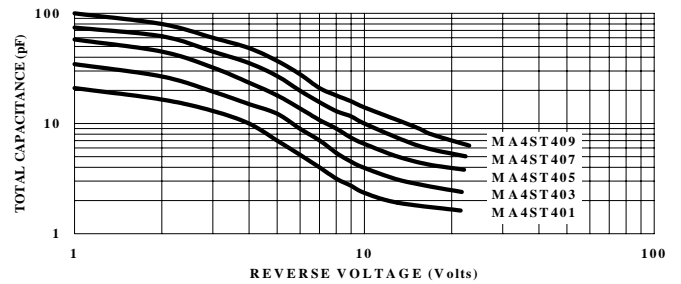

Electrical Specifications @ $T_A = +25^\circ\text{C}$

Minimum Breakdown Voltage (V_B) = 22 Volts at 10 μA ,
 Maximum Reverse (I_R) = 100 nA at 20 Volts

Model Number	Total Capacitance $C_{T4} \pm 10\%$	Minimum Capacitance Ratio C_{T2}/C_{T20}	Maximum Q
MA4ST401	10 pF	6.0	250
MA4ST402	12 pF	6.5	250
MA4ST403	15 pF	7.0	250
MA4ST404	18 pF	7.0	175
MA4ST405	22 pF	7.5	175
MA4ST406	27 pF	8.0	150
MA4ST407	33 pF	9.0	150
MA4ST408	39 pF	9.5	150
MA4ST409	47 pF	9.5	150
Test Conditions	F = 1 MHz $V_R = 4$ Volts	F = 1 MHz	F = 50 MHz $V_R = 4$ Volts

Case Styles

SOT-23
Case Style 287

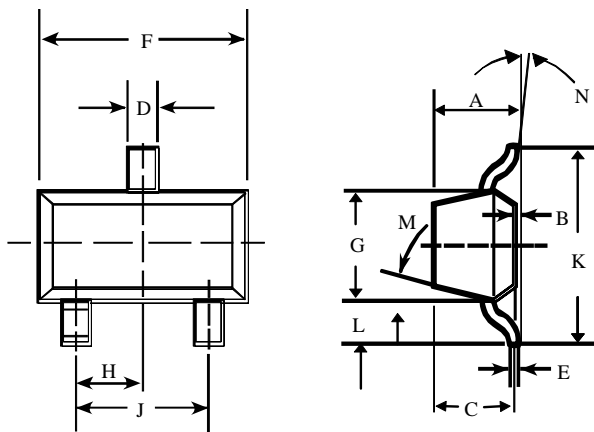

SOT-23 (Case Style 287)

DIM.	INCHES		MILLIMETERS	
	MIN.	MAX.	MIN.	MAX.
A	—	0.048	—	1.22
B	—	0.008	—	0.20
C	—	0.040	—	1.00
D	0.013	0.020	0.35	0.50
E	0.003	0.006	0.08	0.15
F	0.110	0.119	2.80	3.00
G	0.047	0.056	1.20	1.40
H	0.037 typical		0.95 typical	
J	0.075 typical		1.90 typical	
K	—	0.103	—	2.60
L	—	0.024	—	0.60

DIM.	GRADIENT
M	10° max. ¹
N	2° . . . 30°

Note:
1. Applicable on all sides.

