

## Features

- Wide Frequency Range
- +42 dBm Output IP3
- 25.5 dB Gain at 2140 MHz
- 26.5 dB Attenuation Range
- Lead-Free 4 mm, 24-Lead PQFN Package
- RoHS\* Compliant and 260°C Reflow Compatible

## Description

The MAAM-009320 is a variable gain amplifier with 26.5 dB of gain control at 2.14 GHz. It has good input IP3 performance over the full attenuation range. External matching components are used to set the center frequency and achieve the return loss performance. The analog control is accomplished through a single control pin of 0 to +3V.

The 4 mm PQFN package is RoHS compliant and compatible with reflow temperatures to 260°C. Applications include transceivers for cellular infrastructure.

## Ordering Information<sup>1,2</sup>

Part Number	Package
MAAM-009320-TR3000	3000 piece reel
MAAM-009320-001SMB	Sample Board, 2140 MHz

1. Reference Application Note M513 for reel size information.
2. All sample boards include 5 loose parts.

## Functional Schematic

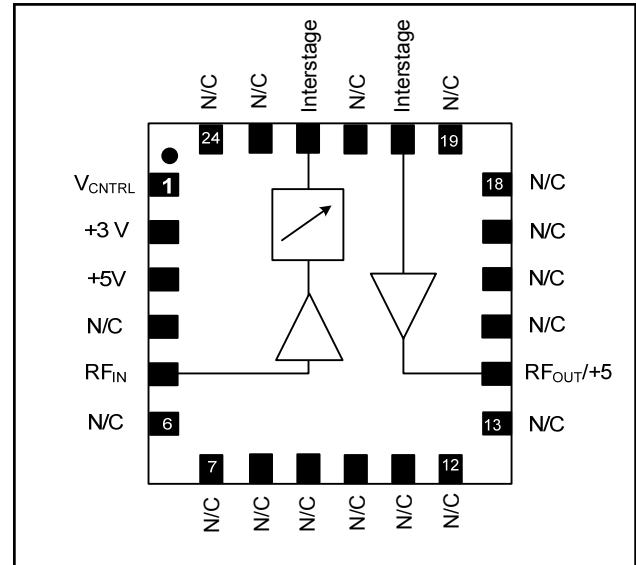

## Pin Configuration<sup>3</sup>

Pin No.	Function	Pin No.	Function
1	V <sub>CNTRL</sub>	13	N/C
2	+3V	14	RF <sub>OUT</sub> /+5V
3	+5V	15	N/C
4	N/C	16	N/C
5	RF <sub>IN</sub>	17	N/C
6	N/C	18	N/C
7	N/C	19	N/C
8	N/C	20	Interstage
9	N/C	21	N/C
10	N/C	22	Interstage
11	N/C	23	N/C
12	N/C	24	N/C
		25	Paddle <sup>4</sup>

3. For optimum RF performance, all N/C's should be terminated to ground.
4. The exposed pad centered on the package bottom must be connected to RF and DC ground.

\* Restrictions on Hazardous Substances, European Union Directive 2002/95/EC.

## Electrical Specifications<sup>5,6,7</sup>: Freq. = 2140 MHz, T<sub>A</sub> = +25°C, Z<sub>0</sub> = 50 Ω

Parameter	Units	Min.	Typ.	Max.
Gain	dB	24	25.5	—
Noise Figure	dB	—	3.0	—
Input Return Loss	dB	—	13	—
Output Return Loss	dB	—	12	—
Output P1dB	dBm	—	28	—
Output IP3 P <sub>out</sub> = +9 dBm per tone SCL, 1 MHz spacing	dBm	40	42	—
Attenuation Range	dB	25	26.5	—
Attenuation Control	V	—	0 to 3	—
Small Signal Current	mA	—	231	300

- Contact M/A-COM Technology Solutions' Application Engineering Department for performance and tuning at other frequencies within frequency range.
- Typical performance at no attenuation, V<sub>cntrl</sub> = 0V.
- Typical small signal currents are 76 mA for stage 1 and 155 mA for stage 3.

## Absolute Maximum Ratings<sup>8,9</sup>

Parameter	Absolute Maximum
Input Power	+6 dBm
Voltage (all DC pins)	6 volts
Storage Temperature	-55°C to +150°C
Case Temperature	-40°C to +85°C
Junction Temp, Stage 1 <sup>10,11</sup>	150°C
Junction Temp, Stage 3 <sup>10,12</sup>	160°C

- Exceeding any one or combination of these limits may cause permanent damage to this device.
- M/A-COM Technology Solutions does not recommend sustained operation near these survivability limits.
- Junction Temperature (T<sub>J</sub>) = T<sub>A</sub> + Θ<sub>jc</sub> \* ((V \* I) - (P<sub>OUT</sub> - P<sub>IN</sub>))
- Stage 1 typical thermal resistance (Θ<sub>jc</sub>) = 106.5° C/W
- Stage 3 typical thermal resistance (Θ<sub>jc</sub>) = 68.6° C/W

## Handling Procedures

Please observe the following precautions to avoid damage:

## Static Sensitivity

Gallium Arsenide Integrated Circuits are sensitive to electrostatic discharge (ESD) and can be damaged by static electricity. Proper ESD control techniques should be used when handling these class 1A devices.

## Typical Performance Curves:

Gain,  $V_{ctrl} = 0V$

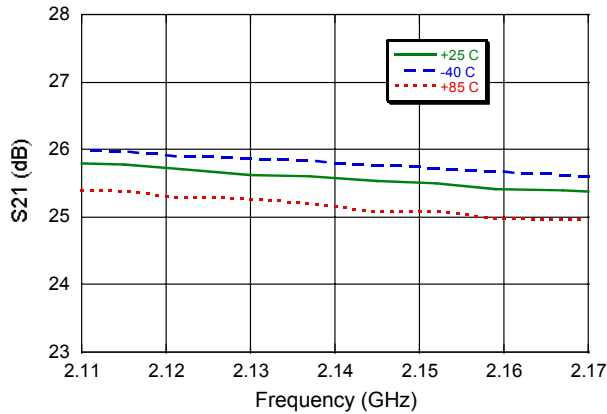

Attenuation Range

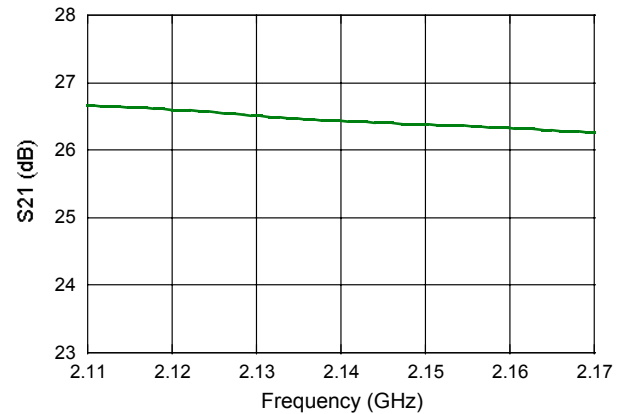

Gain vs. Control Voltage

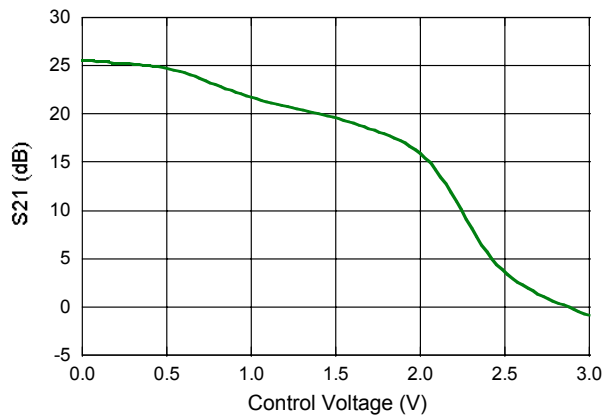

Reverse Isolation,  $V_{ctrl} = 0V$

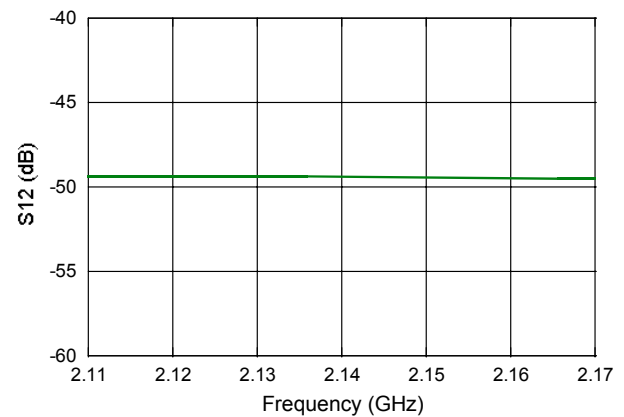

Input Return Loss

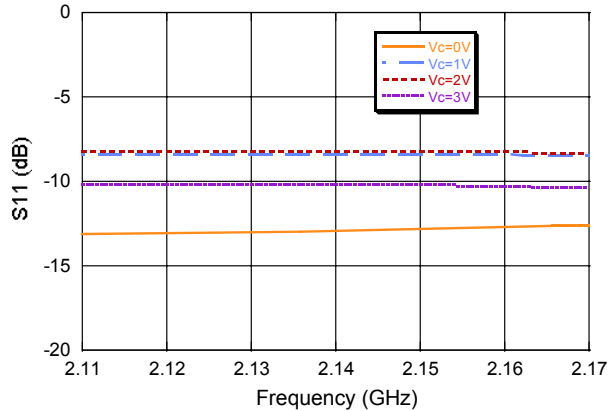

Output Return Loss

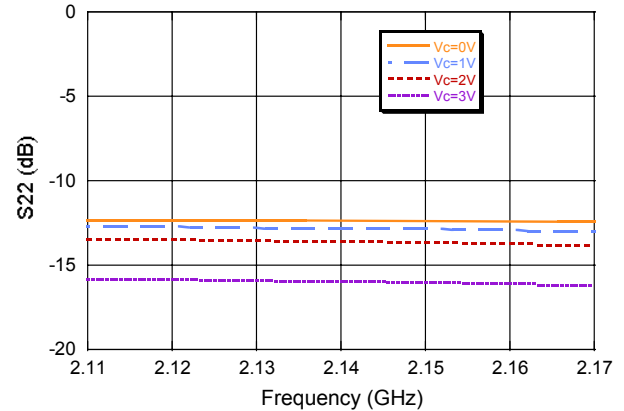

## Typical Performance Curves:

**Output IP3, Vctrl = 0V**

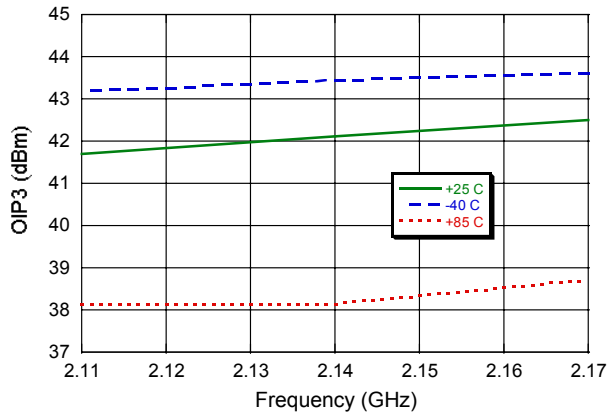

**Input IP3 vs. Control Voltage**

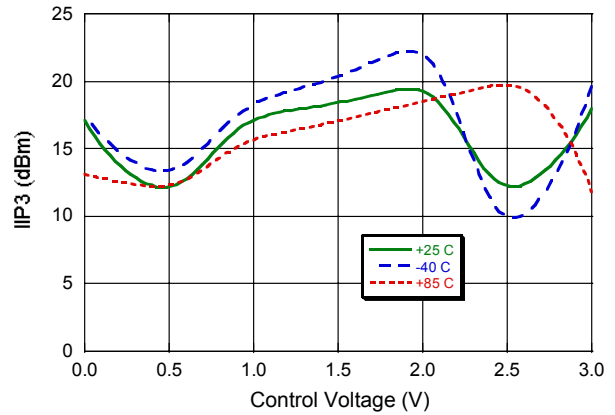

**Output P1dB, Vctrl = 0V**

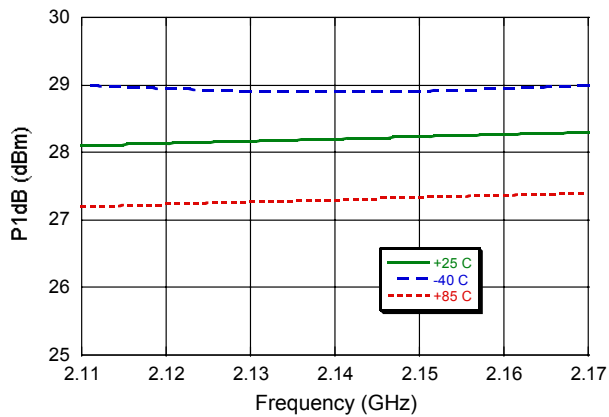

**Input P1dB vs. Control Voltage**

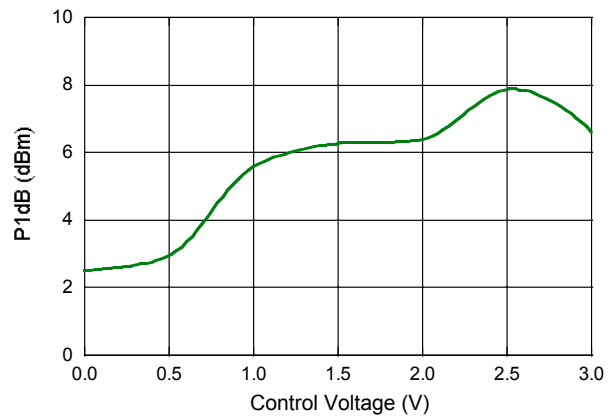

**Noise Figure, Vctrl = 0V**

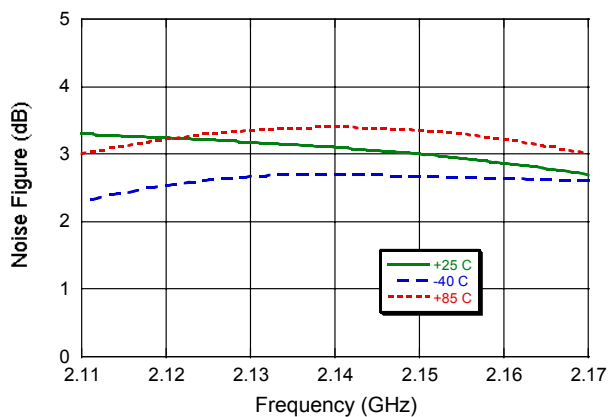

**Noise Figure vs. Control Voltage**

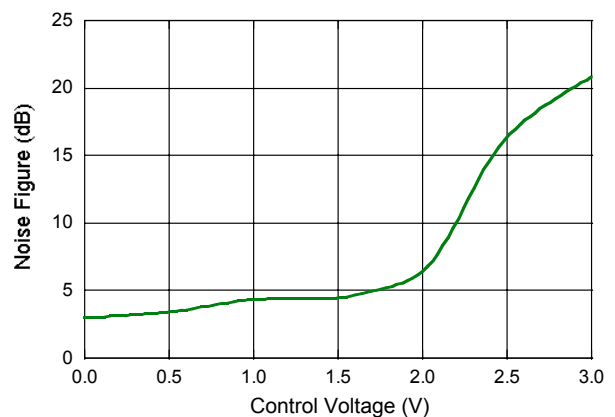

### 2140 MHz PCB Layout

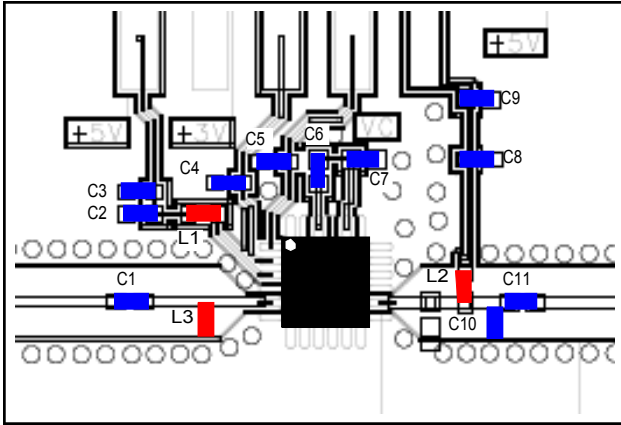

### Parts List

Part	Value	Case Style
C1	68 pF	0402
C2, C4, C5, C8	1000 pF	0402
C3, C9	0.1 μF	0402
C6	12 pF	0402
C7	2.2 pF	0402
C10	1.5 pF	0402
C11	39 pF	0402
L1	39 nH	0402
L2	7.5 nH	0402
L3	3.9 nH	0402

### 2140 MHz Schematic

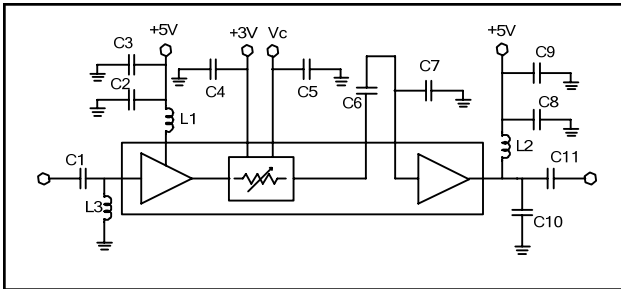

### Cross Section View

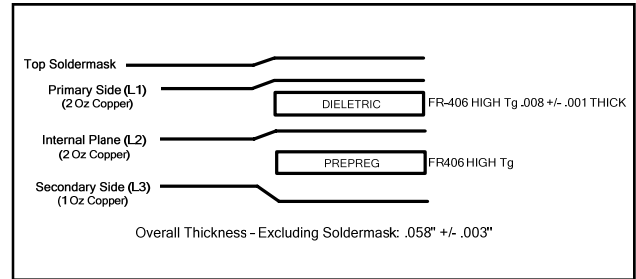

### Lead Free 4 mm 24-Lead PQFN †

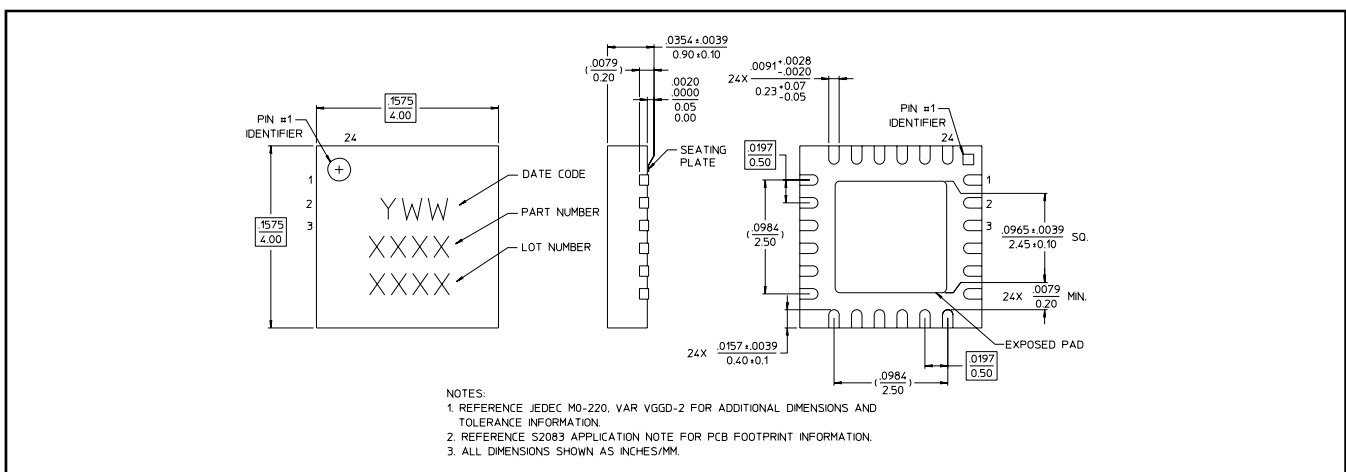

† Reference Application Note M538 for lead-free solder reflow recommendations.  
 Meets JEDEC moisture sensitivity level 1 requirements.  
 Plating is 100% matte tin over copper.

## 400 MHz Applications Section

### Schematic

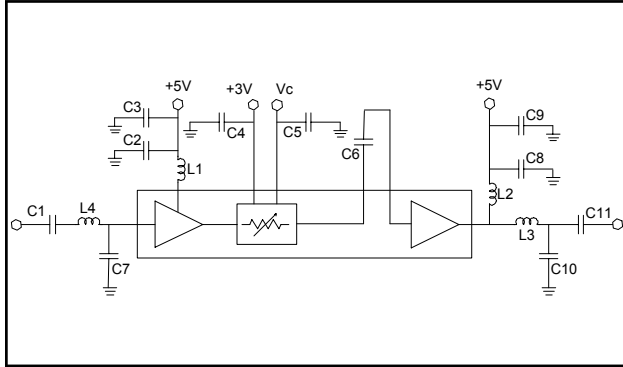

### Parts List

Part	Value	Case Style
C1, C11	39 pF	0402
C2, C4, C5, C8	1000 pF	0402
C3, C9	0.1 $\mu$ F	0402
C6	4.7 pF	0402
C7	4 pF	0402
C10	18 pF	0402
L1	39 nH	0402
L2	7.5 nH	0402
L3	3.9 nH	0402
L4	12 nH	0402

### Gain, Vcntrl = 0V

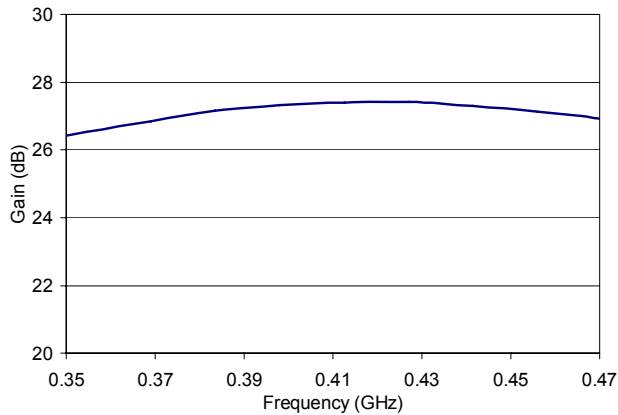

### Attenuation Range

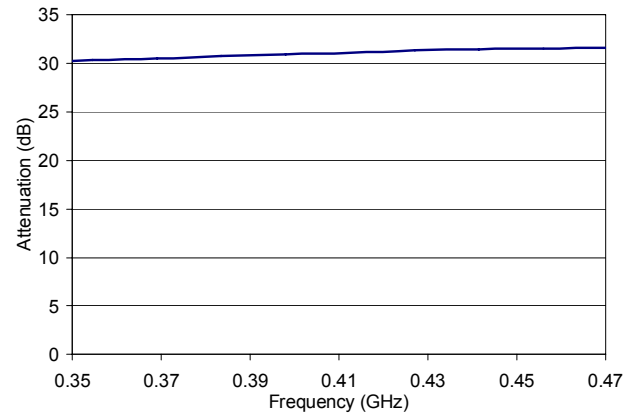

### 400 MHz Applications Section

**Input Return Loss**

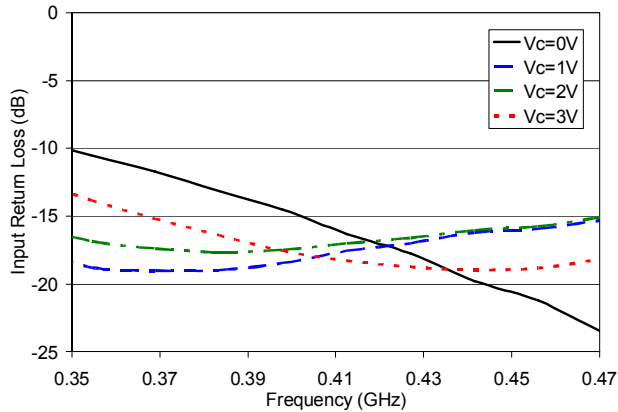

**Output Return Loss**

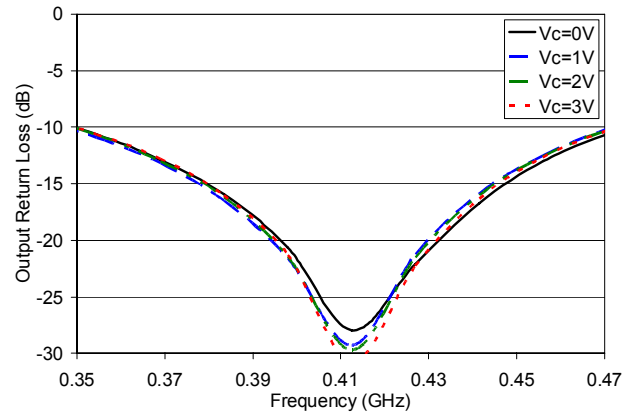

**Output IP3, Vcntrl = 0V**

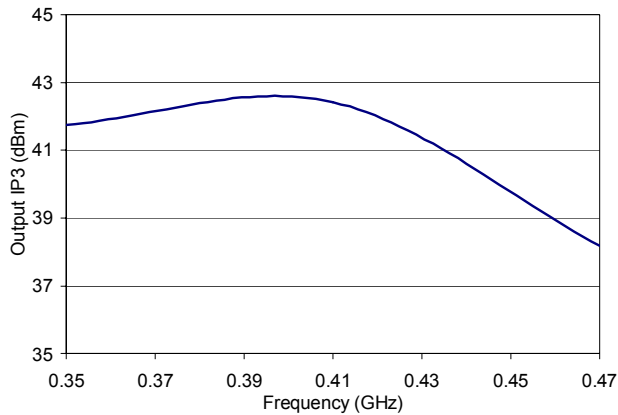

**Input IP3 vs. Control Voltage**

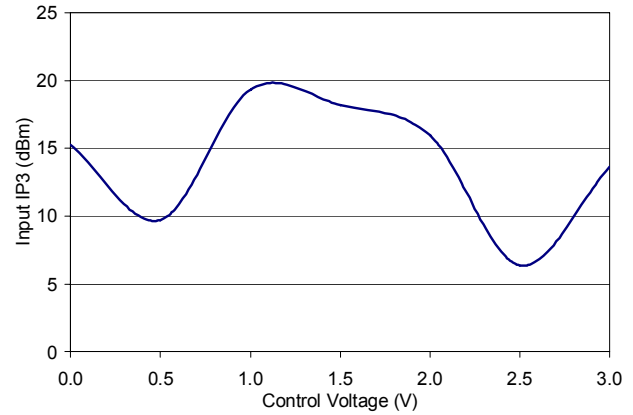

**Output P1dB, Vcntrl = 0V**

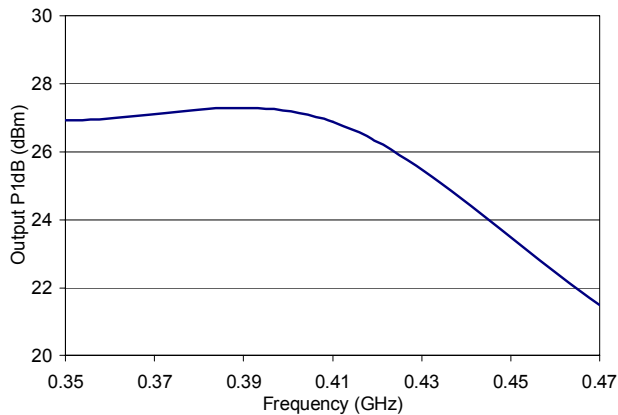

**Input P1dB vs. Control Voltage**

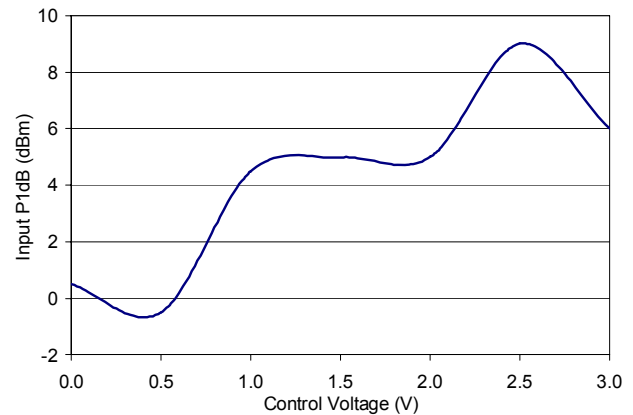

## 850 MHz Applications Section

### Schematic

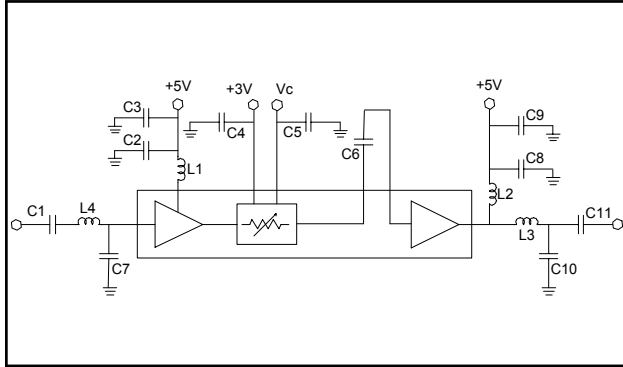

### Parts List

Part	Value	Case Style
C1, C11	39 pF	0402
C2, C4, C5, C8	1000 pF	0402
C3, C9	0.1 $\mu$ F	0402
C6	4.7 pF	0402
C7	1.2 pF	0402
C10	6.8 pF	0402
L1	39 nH	0402
L2	7.5 nH	0402
L3	1 nH	0402
L4	10 nH	0402

### Gain, Vcntrl = 0V

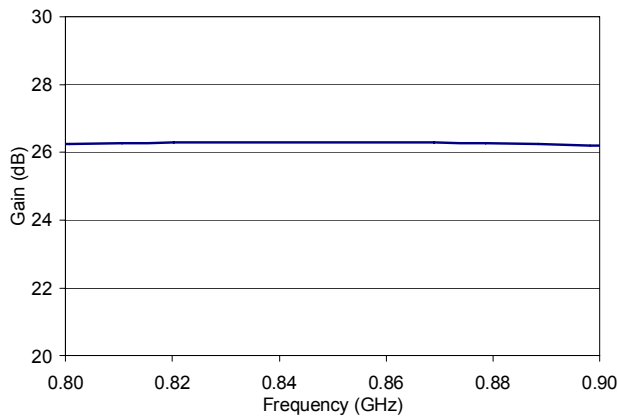

### Attenuation Range

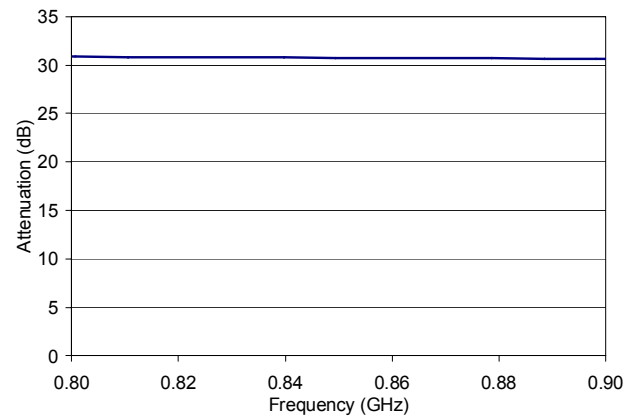



## 850 MHz Applications Section

**Input Return Loss**

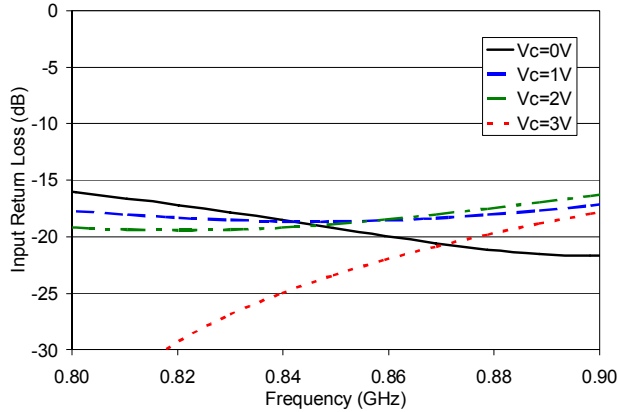

**Output Return Loss**

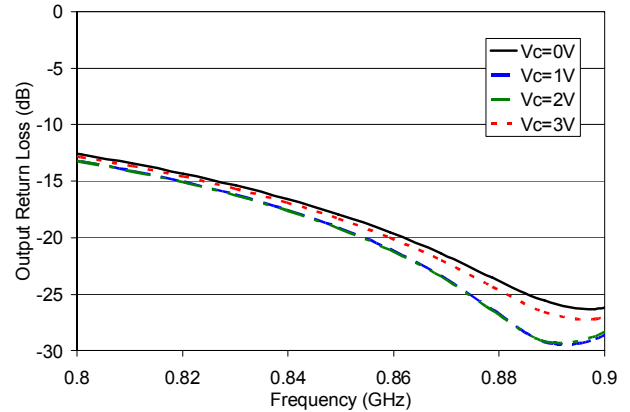

**Output IP3, Vcntrl = 0V**

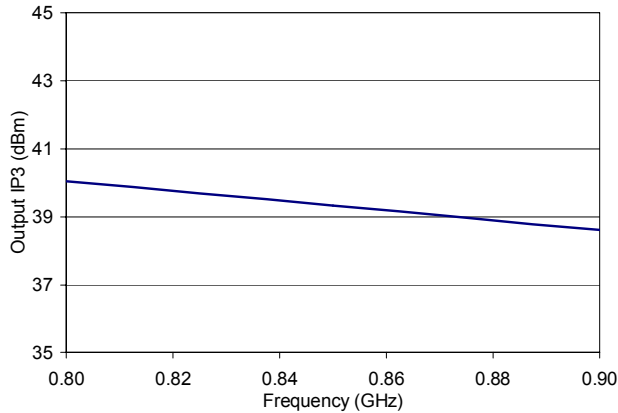

**Input IP3 vs. Control Voltage**

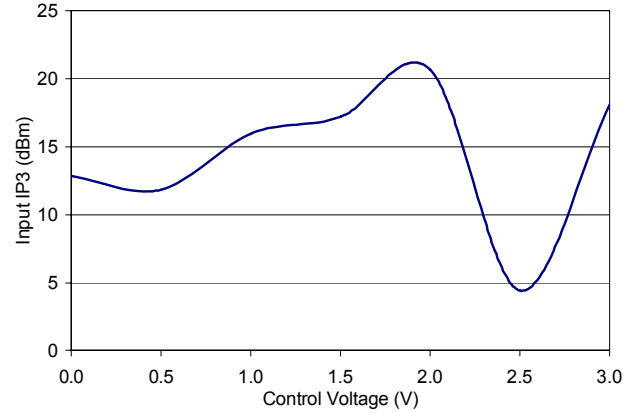

**Output P1dB, Vcntrl = 0V**

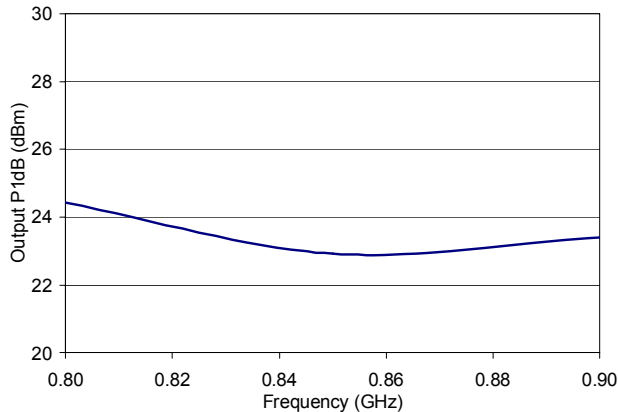

**Input P1dB vs. Control Voltage**

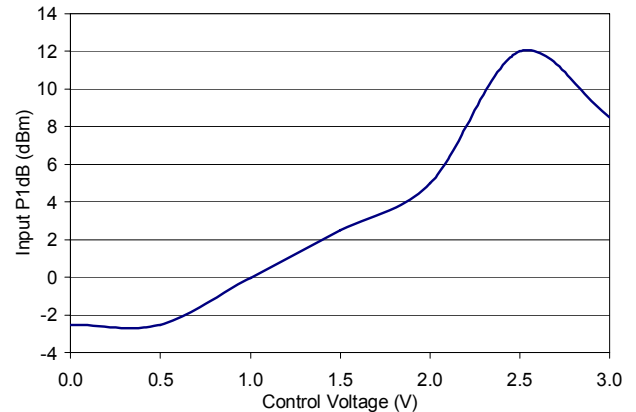

## 2600 MHz Applications Section

### Schematic

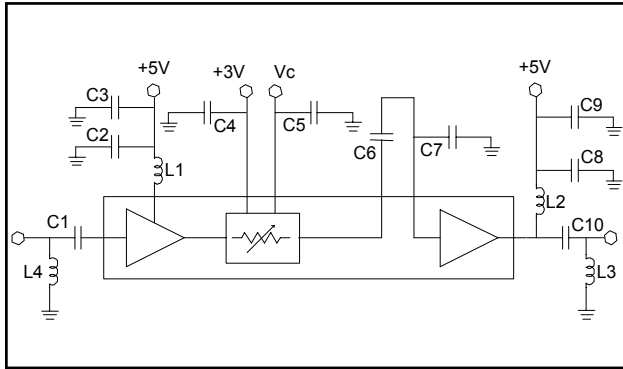

### Parts List

Part	Value	Case Style
C1	3.9 pF	0402
C2, C4, C5, C8	1000 pF	0402
C3, C9	0.1 $\mu$ F	0402
C6	6.8 pF	0402
C7	1.2 pF	0402
C10	1 pF	0402
L1	39 nH	0402
L2	7.5 nH	0402
L3	1.8 nH	0402
L4	3.9 nH	0402

Gain,  $V_{cctrl} = 0V$

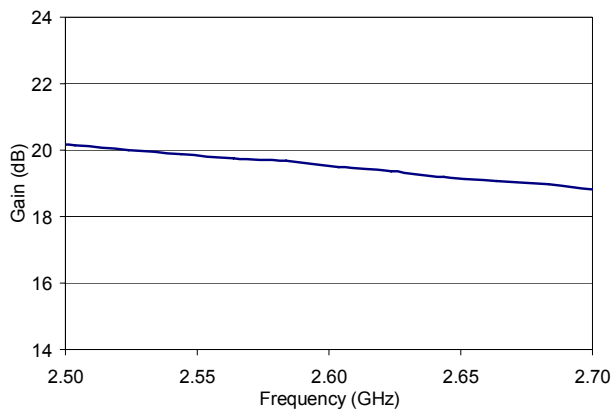

Attenuation Range

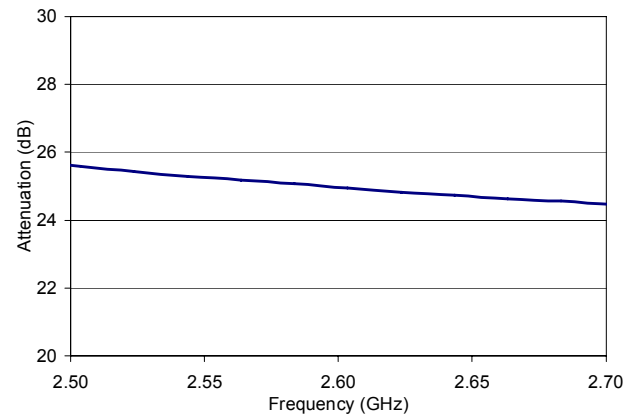

### 2600 MHz Applications Section

**Input Return Loss**

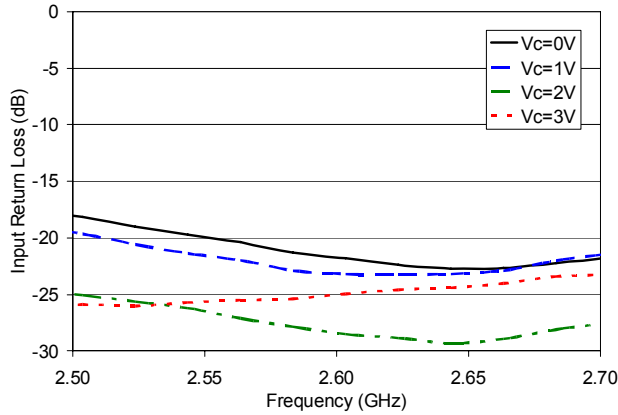

**Output Return Loss**

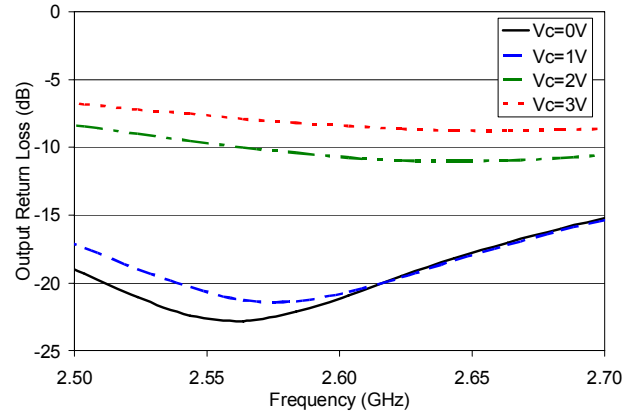

**Output IP3, Vcntrl = 0V**

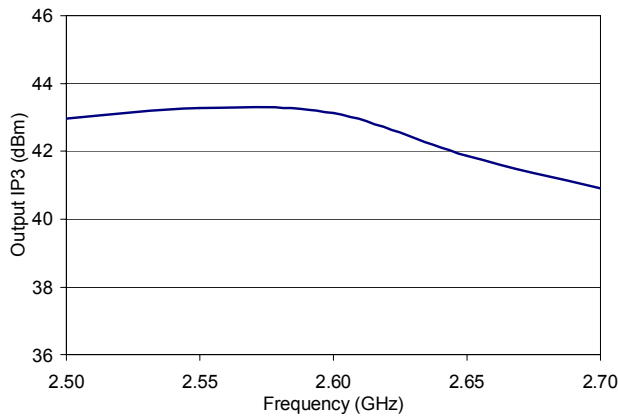

**Input IP3 vs. Control Voltage**

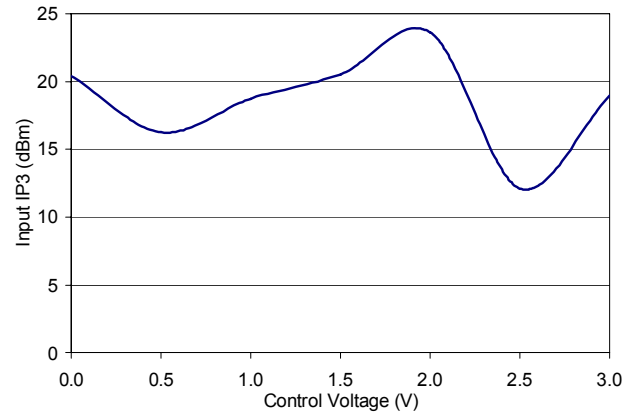

**Output P1dB, Vcntrl = 0V**

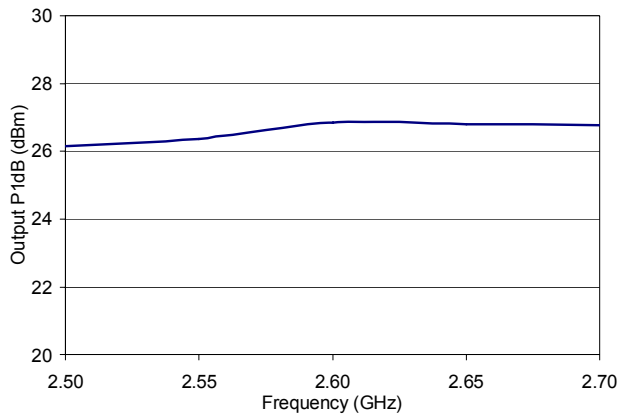

**Input P1dB vs. Control Voltage**

