

**Broadband Driver Amplifier**  
**500 - 2400 MHz**

**MAAMSS0014**  
**V3**

**Features**

- Low Cost Plastic SOT-89 Package
- Broadband Operation
- 18 dBm Pout at -50 dBc ACPR
- 24 dBm P1dB

**Description**

M/A-COM's MAAMSS0014 RF driver amplifier is a GaAs MMIC which exhibits excellent ACPR performance as well as high gain and low power consumption in a low-cost SOT-89 surface mount plastic package.

The MAAMSS0014 employs a monolithic single stage design featuring a convenient 50-ohm input/output impedance. This device runs off a single +5 volt supply and draws 110 mA typically. The design provides excellent performance from 500 to 2400 MHz.

The MAAMSS0014 is fabricated using M/A-COM's iHBT process to realize low current and high power functionality. The process features full passivation for increased performance and reliability.

**Functional Schematic**

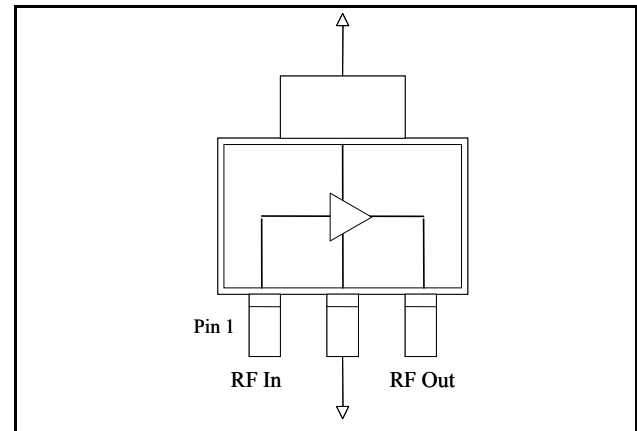

**Pin Configuration**

Pin No.	Function	Pin No.	Function
1	RF In	3	RF Out/Bias
2	GND		

**Ordering Information**

Part Number	Package
MAAMSS00014SMB-01	900 MHz Standard Sample Kit
MAAMSS00014SMB-02	1900 MHz Standard Sample Kit
MAAMSS0014TR	1000 Piece Tape and Reel*
MAAMSS0014TR-3000	3000 Piece Tape and Reel*

\* Reference Application Note M513 for reel size information.

**Absolute Maximum Ratings<sup>1,2</sup>**

Parameter	Absolute Maximum
RF Input Power <sup>2</sup>	
500 MHz	0 dBm
900 MHz	2 dBm
1900 MHz	4 dBm
Voltage	6.0 volts
Operating Temperature	-40 °C to +85 °C
Storage Temperature	-65 °C to +150 °C

1. Exceeding any one or combination of these limits may cause permanent damage to this device.
2. The MAAMSS0014 is designed to operate optimally at 10 dB backed off from its output P1dB of 24 dBm. Driving the device at higher power levels could degrade performance.

**Sample Board Layout**

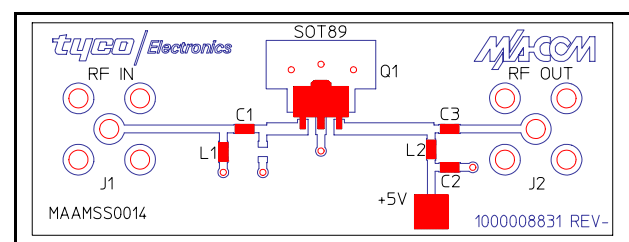

**Broadband Driver Amplifier**  
**500 - 2400 MHz**

**MAAMSS0014**  
**V3**

**Cellular Band Electrical Specifications:  $T_A = 25^\circ\text{C}$ ,  $Z_0 = 50 \Omega$ ,  $V_{CC} = 5 \text{ V}$ ,  $P_{IN} \leq -5 \text{ dBm}$**

Parameter	Test Conditions	Frequency	Units	Min	Typ	Max
Gain	—	900 MHz	dB	17	19	21
Input Return Loss	—	800 - 1000 MHz	dB	—	8	—
Output Return Loss	—	800 - 1000 MHz	dB	—	11	—
Output IP3	Two tones, 0.3 MHz spacing, -11 dBm / tone	900 MHz	dBm	35	38	—
$P_{OUT}$	ACPR=-50 dBc, 9 Channels Forward	880 MHz	dBm	—	18	—
P1dB	—	800 - 1000 MHz	dBm	—	24	—
Noise Figure	—	800 - 1000 MHz	dB	—	5	—
Current	—	—	mA	—	110	130

**PCS Band Electrical Specifications:  $T_A = 25^\circ\text{C}$ ,  $Z_0 = 50 \Omega$ ,  $V_{CC} = 5 \text{ V}$ ,  $P_{IN} \leq 0 \text{ dBm}$**

Parameter	Test Conditions	Frequency	Units	Min	Typ	Max
Gain	—	1800 - 2200 MHz	dB	—	14.5	—
Input Return Loss	—	1800 - 2200 MHz	dB	—	8	—
Output Return Loss	—	1800 - 2200 MHz	dB	—	20	—
Output IP3	Two tones, 0.3 MHz spacing, -6.5 dBm/tone	1800 - 2200 MHz	dBm	—	38	—
$P_{OUT}$	ACPR=-50 dBc, 9 Channels Forward	1960 MHz	dBm	—	19	—
P1dB	—	1800 - 2200 MHz	dBm	—	24	—
Noise Figure	—	1800 - 2200 MHz	dB	—	5	—
Current	—	—	mA	—	110	130

**Component List**

Cellular Configuration	Value	Style	Manufacturer
C1	5 pF	0603	Murata
C2	3300 pF	0603	Murata
C3	8 pF	0603	Murata
L1	7.5 nH	0603	Coilcraft
L2	120 nH	0603	Coilcraft

PCS Configuration	Value	Style	Manufacturer
C1	1.5 pF	0603	Murata
C2	2200 pF	0603	Murata
C3	4 pF	0603	Murata
L1	5.1 nH	0603	Coilcraft
L2	47 nH	0805	Coilcraft

**Operating the MAAMSS0014**

The MAAMSS0014 can be damaged by electrostatic discharge (ESD). Use proper ESD control techniques when handling this device. To operate the MAAMSS0014, follow these steps.

1. Apply  $V_{CC}$  (5.0 V).
2. Set  $P_{IN}$ .
3. Turn off in reverse order.

**Application Schematic**

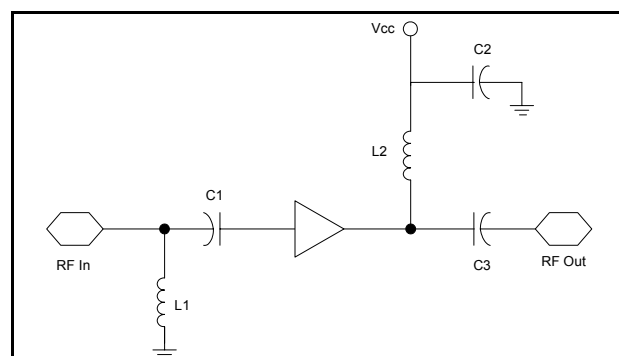

**Typical Performance Curves - Cellular Band**

**Gain**

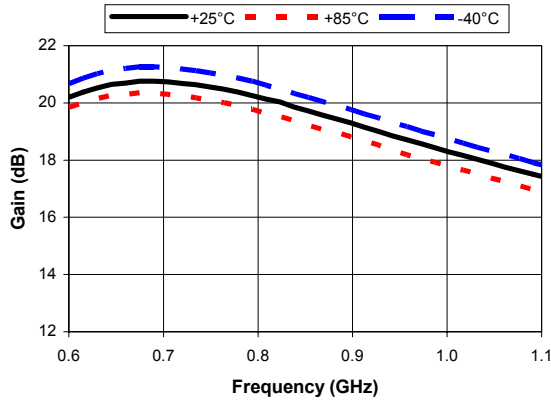

**Reverse Isolation**

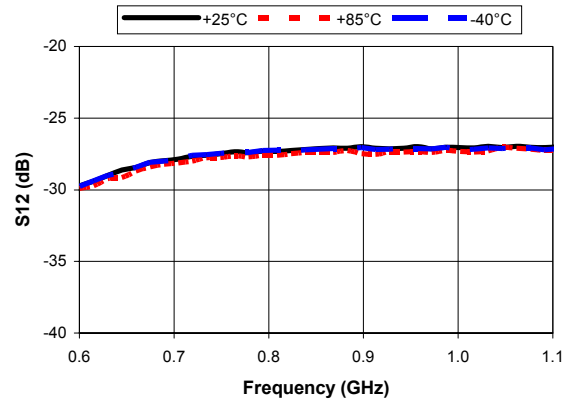

**Input Return Loss**

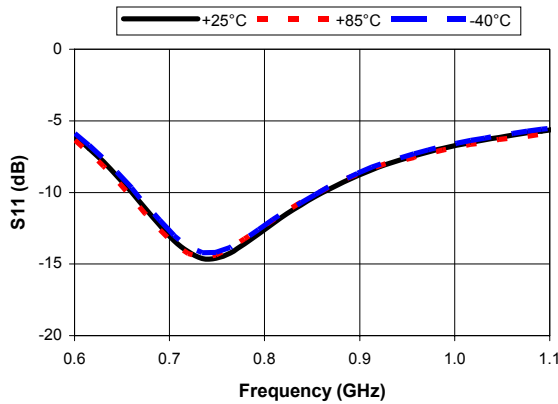

**Output Return Loss**

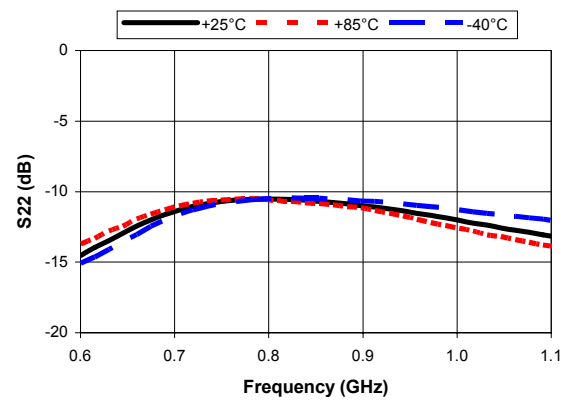

**OIP3 ( $P_{IN} = -11$  dBm / tone)**

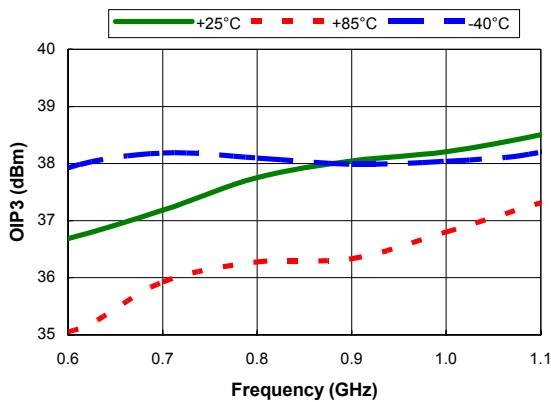

**Noise Figure**

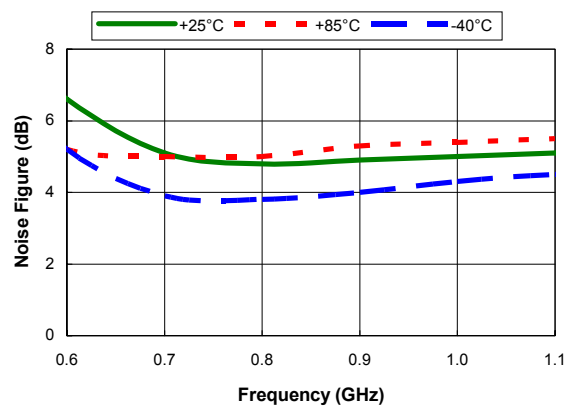

**Typical Performance Curves - PCS Band**

**Gain**

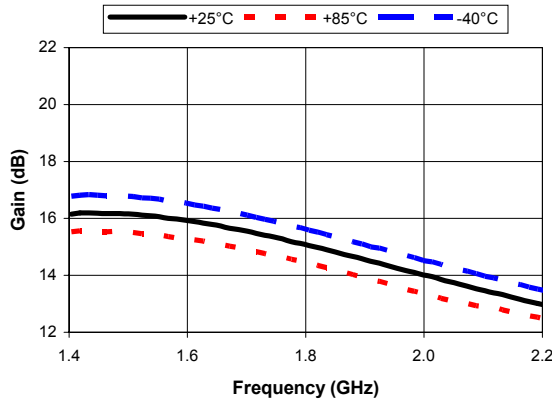

**Reverse Isolation**

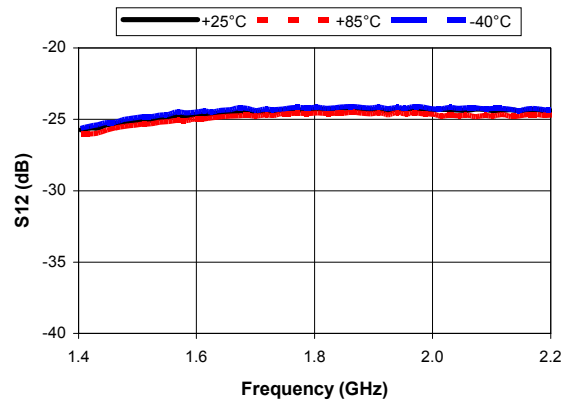

**Input Return Loss**

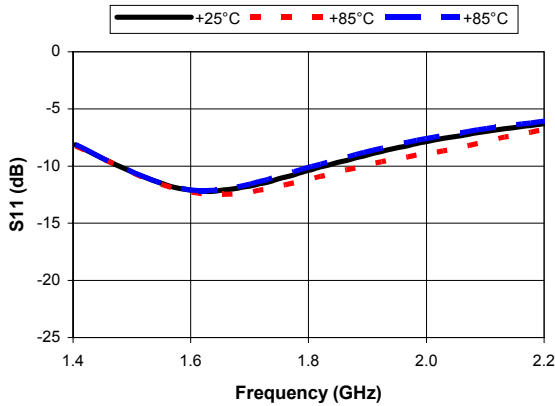

**Output Return Loss**

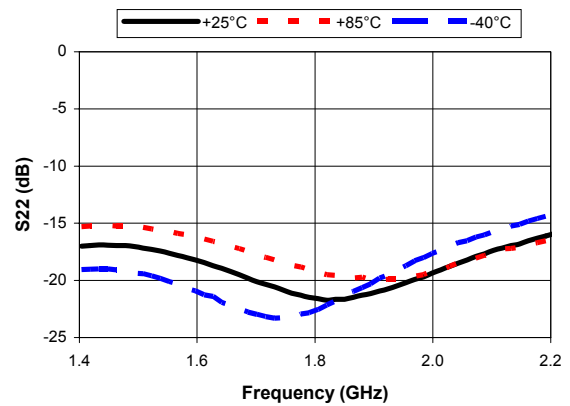

**OIP3 ( $P_{IN} = -6.5$  dBm / tone)**

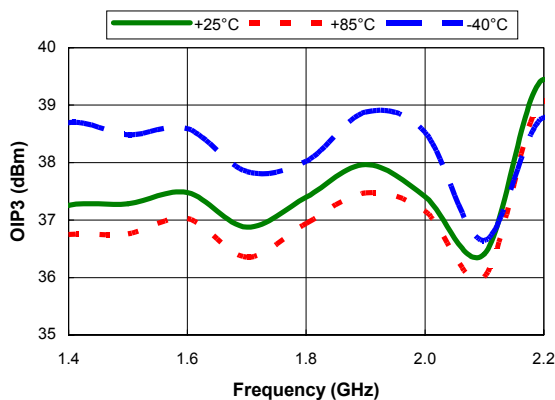

**Noise Figure**

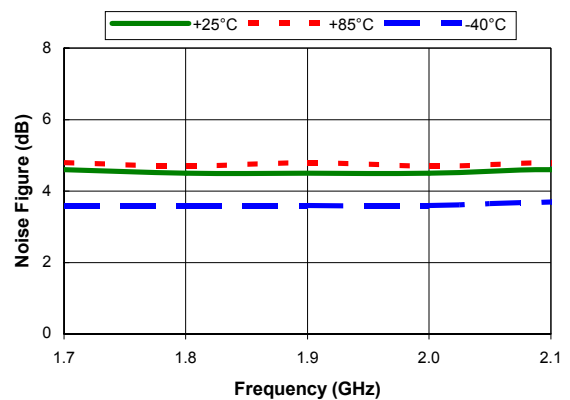

**Broadband Driver Amplifier  
500 - 2400 MHz**

**MAAMSS0014  
V3**

**Typical Performance Curves**

**ACPR - Cell Band (9 channels Forward)**

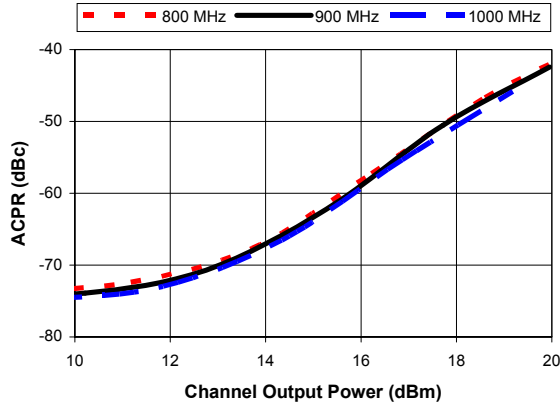

**ACPR - PCS Band (9 channels Forward)**

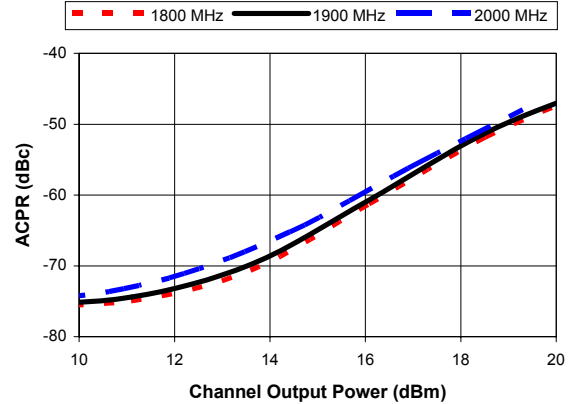

**SOT-89 Plastic Package**

