

MACP-009011-C80370



E-Series 75 Ohm 8 dB Coupler
5 - 1200 MHz

M/A-COM Products
Revision : V2

Features

- Coupling 8dB Typical
- Surface Mount
- Low Profile
- Available on Tape and Reel
- Excellent Temperature Stability

Description

M/A-COM's MACP-009011-C80370 is a high performance 75 Ohm Coupler, in a SM-55A low cost, surface mount package.

The MACP-009011-C80370 is designed for use in high volume CATV applications. Typical applications include set-top boxes, Network Interface Units, Broadband Amplifiers and head-end equipment.

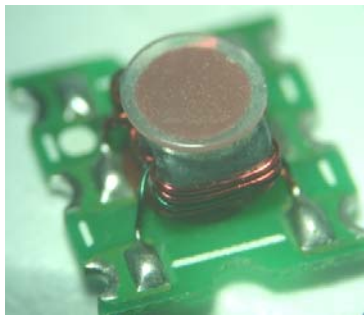

Schematic

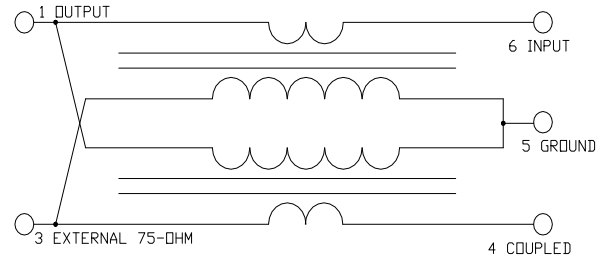

Case Style SM-55A

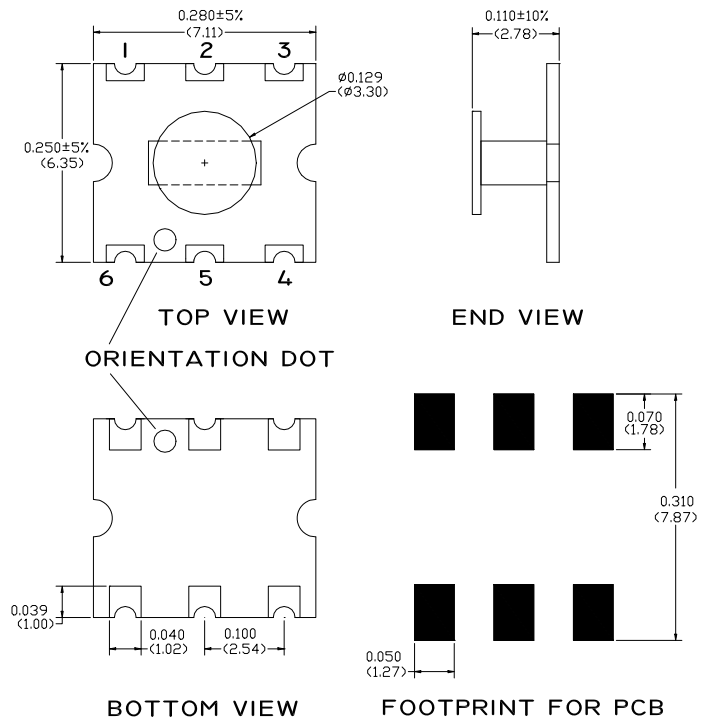

Dimensions in inches [mm] Tolerance: .xx ± .02, .xxx ± .010

Pin Configuration

Function	Pin Number
Output	1
Not Connected	2
Isolation, external 75-Ohm	3
Coupled	4
Ground	5
Input	6

Ordering Information

Part Number	Function
MACP-009011-C80370	900 parts per reel
MACP-009011-C803TB	Customer test board

1

ADVANCED: Data Sheets contain information regarding a product M/A-COM Technology Solutions is considering for development. Performance is based on target specifications, simulated results, and/or prototype measurements. Commitment to develop is not guaranteed.

PRELIMINARY: Data Sheets contain information regarding a product M/A-COM Technology Solutions has under development. Performance is based on engineering tests. Specifications are typical. Mechanical outline has been fixed. Engineering samples and/or test data may be available. Commitment to produce in volume is not guaranteed.

• **North America** Tel: 800.366.2266 • **Europe** Tel: +353.21.244.6400
 • **India** Tel: +91.80.4155721 • **China** Tel: +86.21.2407.1588
 Visit www.macomtech.com for additional data sheets and product information.

M/A-COM Technology Solutions Inc. and its affiliates reserve the right to make changes to the product(s) or information contained herein without notice.

Electrical Specifications: $T_A = 25^\circ\text{C}$, $Z_0 = 75\Omega$

Parameter	Frequency	Units	Min.	Typ.	Max
Frequency Range	5-1200 MHz				
Mainline Loss *	5-870 MHz	dB	2.0	1.5	—
	870-1002 MHz	dB	2.3	1.85	—
	1002-1200 MHz	dB	2.6	2.1	—
Coupling *	5-1002 MHz	dB	8.5	8.3	7.5
	1002-1200 MHz	dB	8.7	8.0	7.3
Coupling flatness	5-1200 MHz	dB	—	0.5	0.8
Directivity	5-870 MHz	dB	—	17.5	11
	870-1200 MHz	dB	—	12.8	9
Return Loss Input	5-50 MHz	dB	—	18.8	17.0
	50-1200MHz	dB	—	18.7	16.5
Return Loss Output	5-50 MHz	dB	—	31.3	23
	50-870 MHz	dB	—	33.5	20
	870-1200 MHz	dB	—	32.0	20
Return Loss Coupled *	5-1200 MHz	dB	—	18.5	16

Absolute Maximum Ratings ¹

Parameter	Absolute Maximum
RF Power	250mW
DC Current	30mA
Operating Temperature	-20° C to + 85° C
Storage Temperature	-20° C to + 85° C

Recommended PCB Configuration

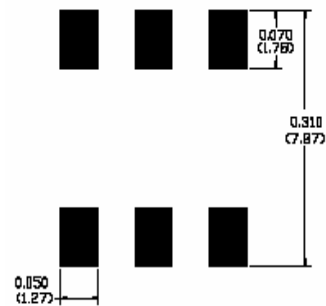

FOOTPRINT FOR PCB

Dimensions in inches [mm] Tolerance: .xx ± .02, .xxx ± .010

* Monitored in production test/tune

MACP-009011-C80370



E-Series 75 Ohm 8 dB Coupler
5 - 1200 MHz

M/A-COM Products
Revision : V2

Typical Performance: $T_A = 25^\circ\text{C}$, $Z_0 = 75\Omega$

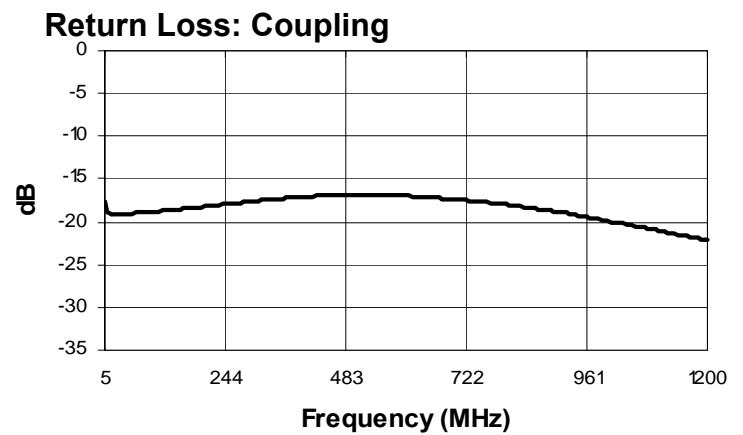
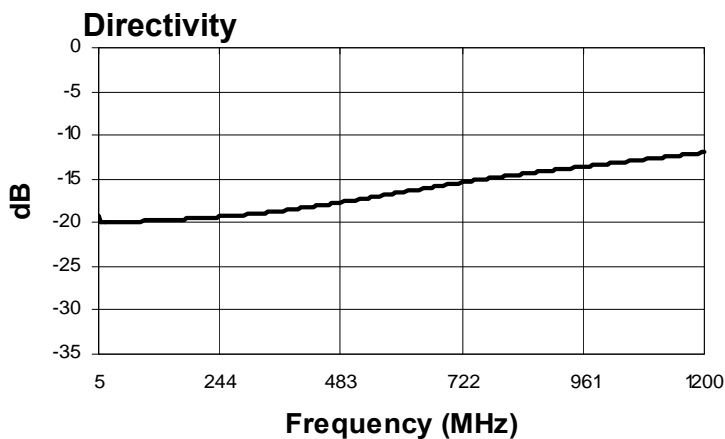
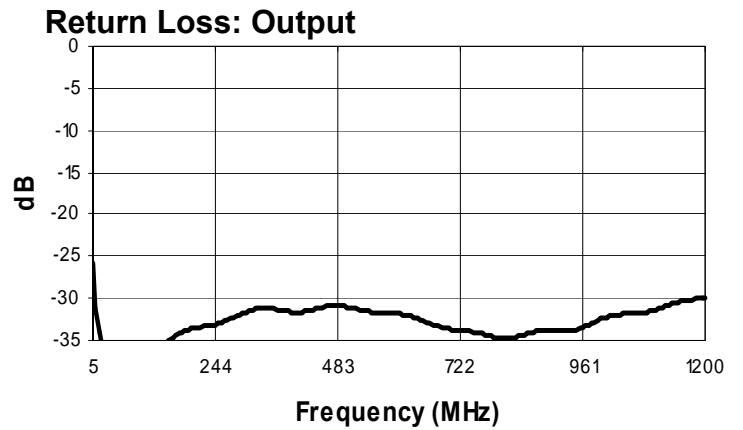
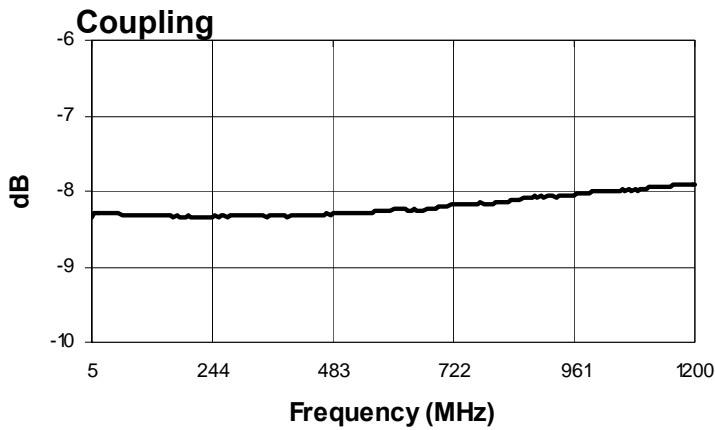
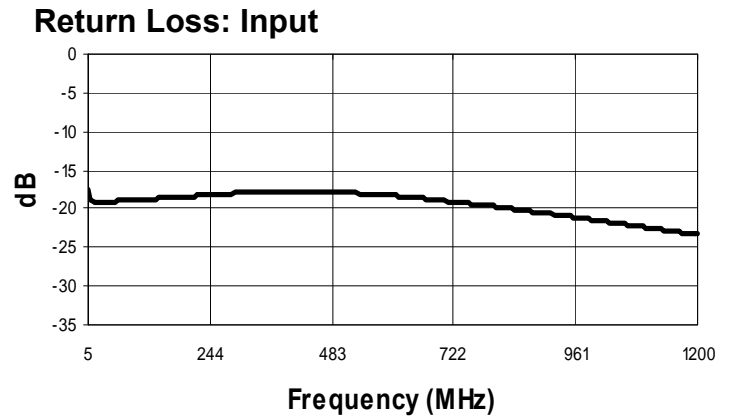
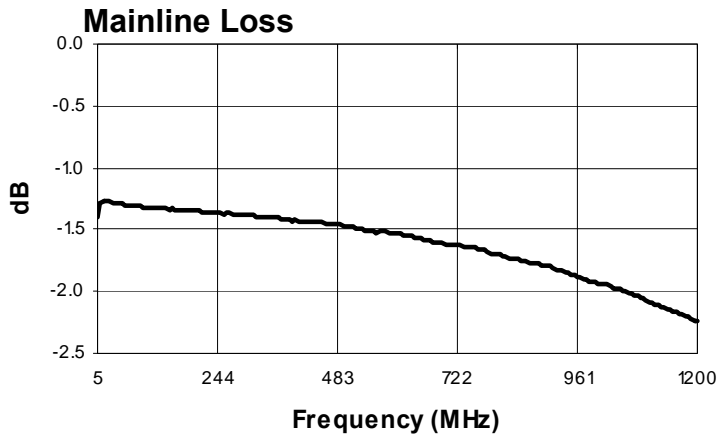

ADVANCED: Data Sheets contain information regarding a product M/A-COM Technology Solutions is considering for development. Performance is based on target specifications, simulated results, and/or prototype measurements. Commitment to develop is not guaranteed.
PRELIMINARY: Data Sheets contain information regarding a product M/A-COM Technology Solutions has under development. Performance is based on engineering tests. Specifications are typical. Mechanical outline has been fixed. Engineering samples and/or test data may be available. Commitment to produce in volume is not guaranteed.

• North America Tel: 800.366.2266 • Europe Tel: +353.21.244.6400
• India Tel: +91.80.4155721 • China Tel: +86.21.2407.1588
Visit www.macomtech.com for additional data sheets and product information.

M/A-COM Technology Solutions Inc. and its affiliates reserve the right to make changes to the product(s) or information contained herein without notice.