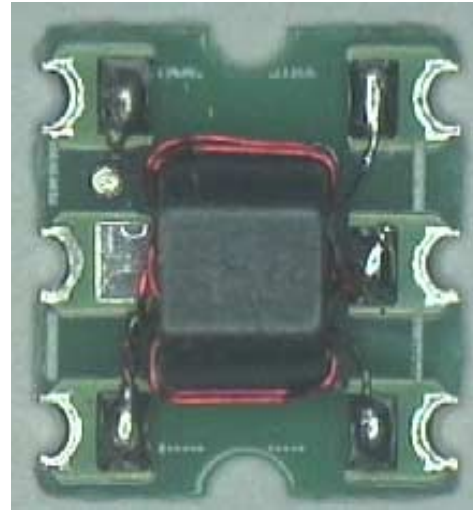

Features

- SMT unit
- Coupling 8dB typical
- Available on tape & reel
- Excellent temperature stability

Description

M/A-COM's MACPCT0014 is a low cost SMT 8dB directional coupler designed for high volume CATV Broadband applications. An external 50 ohm load is required on the isolated port. Typical applications include set-top boxes, network interface units, cable amplifiers and headend equipment.

**Electrical Specifications @ 25°C, Z₀ = 50 Ohm**

Parameter	Test Conditions	Units	Min.	Typ.	Max.
Frequency Range: 50-870 MHz					
Coupling	50 - 870 MHz	dB	—	8.0	±0.5
Coupling Flatness	50 - 870 MHz	dB	—	—	1.0
Main Line Loss	50 - 500 MHz 500 - 870 MHz	dB dB	— —	1.2 1.6	1.5 2.0
Isolation	50 - 200 MHz 200 - 870 MHz	dB dB	26 20	29 24	— —
Input Return Loss	50 - 870 MHz	dB	17	19	—
Output Return Loss	50 - 500 MHz 500 - 870 MHz	dB dB	20 18	25 23	— —
Coupled Port Return Loss	50 - 870 MHz	dB	16	18	—

M/A-COM Inc. and its affiliates reserve the right to make changes to the product(s)
Or information contained herein without notice

Visit www.macom.com for additional data sheets and product information

■ North America: Tel. (800) 366-266, Fax (800) 618-8883
 ■ Asia/Pacific: Tel.+ 81-44-844-8296, Fax+81-44-844-8298
 ■ Europe: Tel. +44(1908) 574 200, Fax +44(1908) 574 300

Typical Performance @ +25°C, 50 Ohm

Coupling: pin 3-1

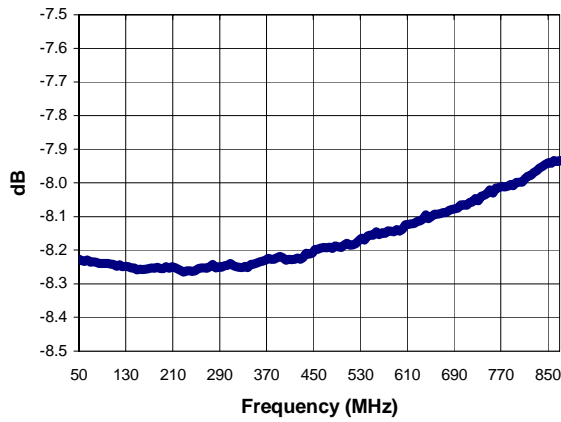

Main Line Loss: pin 6-1

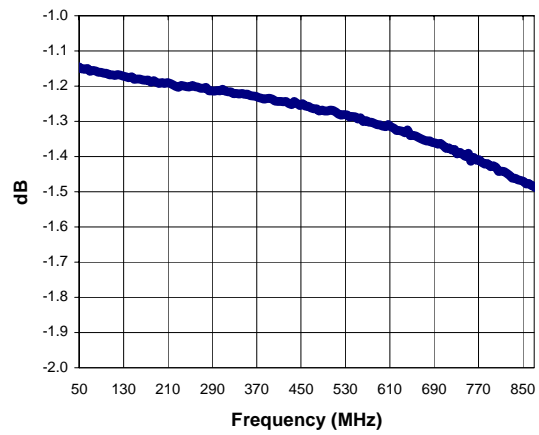

Isolation

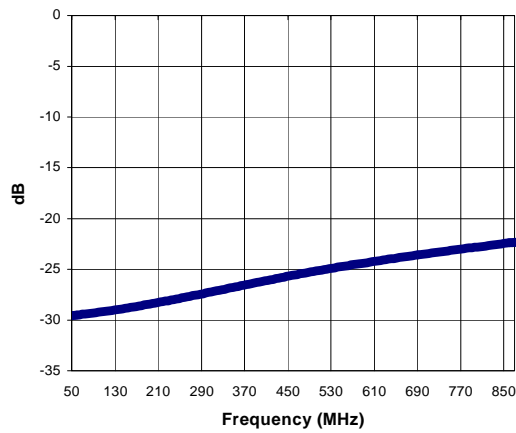

Return Loss: Input port

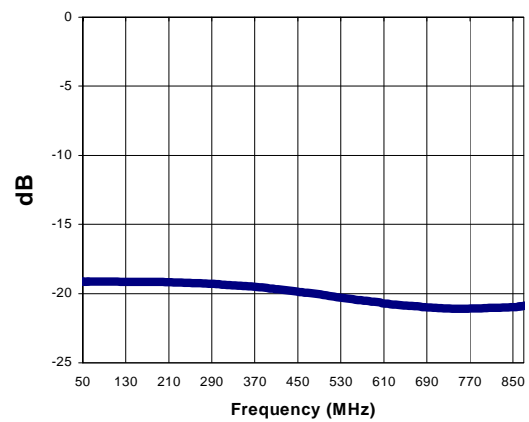

Absolute Maximum Ratings ¹

	Absolute Maximum
RF Power	250 mW
DC Current	30 mA
Operating/Storage Temperature	-20° C to +85° C

¹ Exceeding one or a combination of these settings may cause permanent damage to the unit

M/A-COM Inc. and its affiliates reserve the right to make changes to the product(s) Or information contained herein without notice

Visit www.macom.com for additional data sheets and product information

■ North America: Tel. (800) 366-266, Fax (800) 618-8883
 ■ Asia/Pacific: Tel.+ 81-44-844-8296, Fax+81-44-844-8298
 ■ Europe: Tel. +44(1908) 574 200, Fax +44(1908) 574 300



SM-55 Case Style

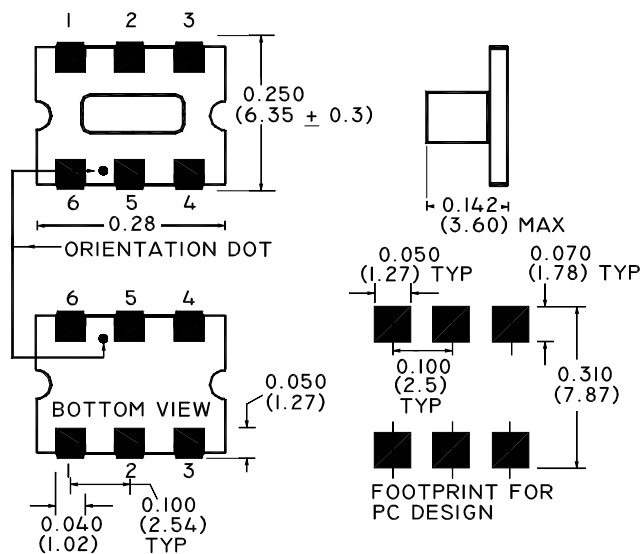

Suggested Footprint

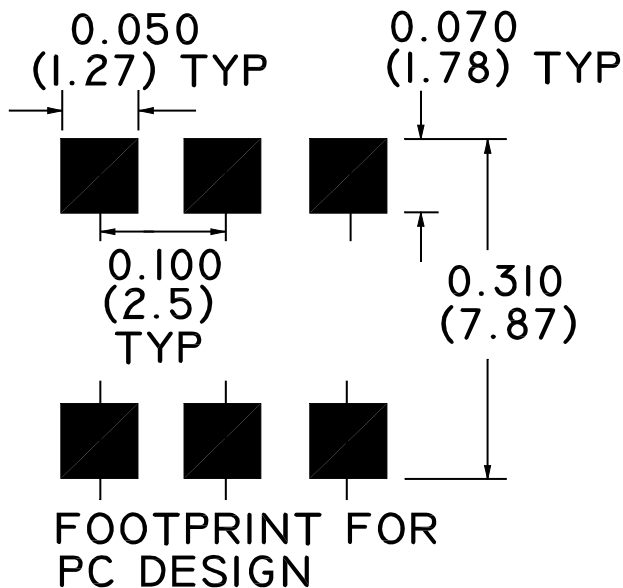

M/A-COM Inc. and its affiliates reserve the right to make changes to the product(s)
 Or information contained herein without notice
 Visit www.macom.com for additional data sheets and product information

■ North America: Tel. (800) 366-266, Fax (800) 618-8883
 ■ Asia/Pacific: Tel.+ 81-44-844-8296, Fax+81-44-844-8298
 ■ Europe: Tel. +44(1908) 574 200, Fax +44(1908) 574 300

Functional Schematic

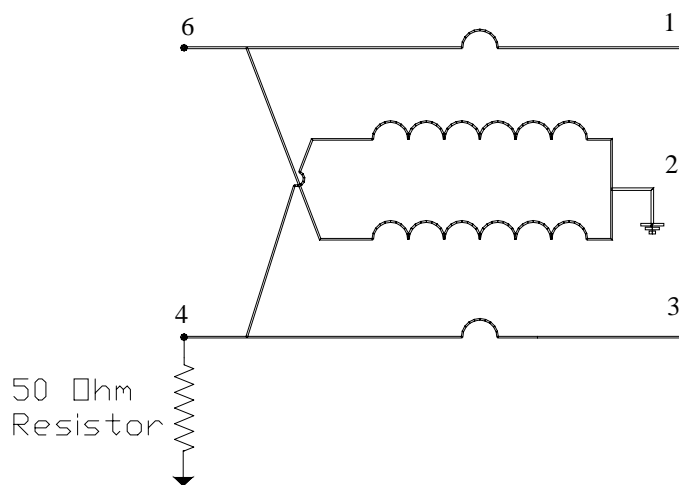

Pin Configuration

Function	Pin No.
Input	1
Coupled	3
Output	6
Isolated (external 50 Ohms)	4
Ground	2&5

M/A-COM Inc. and its affiliates reserve the right to make changes to the product(s)
 Or information contained herein without notice
 Visit www.macom.com for additional data sheets and product information

■ North America: Tel. (800) 366-266, Fax (800) 618-8883
 ■ Asia/Pacific: Tel.+ 81-44-844-8296, Fax+81-44-844-8298
 ■ Europe: Tel. +44(1908) 574 200, Fax +44(1908) 574 300

