

**Dual-Band/Triple-Mode Downconverter**  
869 - 893 MHz and 1930 - 1990 MHz

**MADCSM0001**  
V2

**Features**

- Highly Integrated Downconverter
- Operates over 2.8 V to 5 V Supply Voltage
- Dual-Band and Triple-Mode Operation
- High Linearity, IP3 = 10 dBm typical
- Adjustable Gain and IP3
- 4 mm 20-Lead PQFN Plastic Package

**Description**

M/A-COM's MADCSM0001 is a downconverter suitable for Dual-Band and Triple-Mode Operation. The MADCSM0001 has a 50-ohm matched input, consumes low DC power and incorporates an on-chip switch that determines CDMA and AMPS mode select. The designer can tailor the linearity and gain performance of the MADCSM0001 according to the system needs.

The MADCSM0001 is ideally suited for wireless applications where low noise, low current and high linearity are important features.

The MADCSM0001 is fabricated using M/A-COM's 0.5-micron low noise E/D GaAs MESFET process. The process features full passivation for increased performance and reliability.

**Ordering Information<sup>1</sup>**

Part Number	Package
MADCSM0001	Bulk Packaging
MADCSM0001TR	1000 piece reel
MADCSM0001SMB	Sample Board

1. Reference Application Note M513 for reel size information.

**Absolute Maximum Ratings<sup>2,3</sup>**

Parameter	Absolute Maximum
Voltage	6 V
Input Power	0 dBm
Operating Temperature	-30°C to +85°C
Storage Temperature	-65°C to +150°C

- Exceeding any one or combination of these limits may cause permanent damage to this device.
- M/A-COM does not recommend sustained operation near these survivability limits.

**Functional Block Diagram**

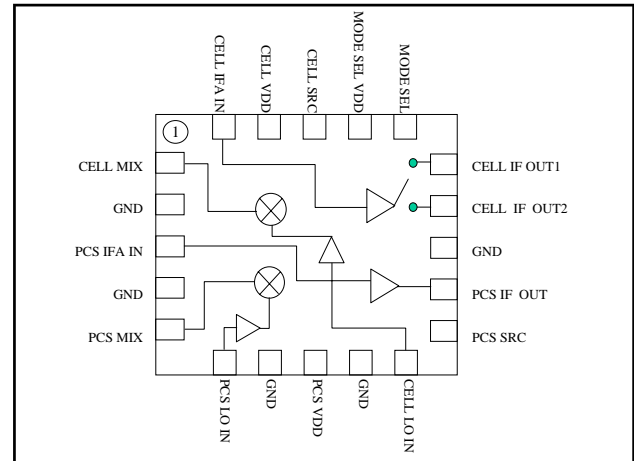

**Pin Configuration**

Pin No.	Function	Description
1	CELL MIX	Cellular Mixer RF Input/ Mixer IF Output
2	GND	DC and RF Ground
3	PCS IFA IN	PCS IFA Input
4	GND	DC and RF Ground
5	PCS MIX	PCS Mixer RF Input/Mixer IF Output
6	PCS LO IN	PCS LO Buffer Input (-10 to -5 dBm)
7	GND	DC and RF Ground
8	PCS VDD	PCS Downconverter Supply Voltage. Must be RF bypassed
9	GND	DC and RF Ground
10	CELL LO IN	Cellular LO Buffer Input (-10 to -5 dBm)
11	PCS SRC	Parallel RC network determines the PCS IFA Current, Gain and IIP3.
12	PCS IF OUT	PCS IF Out. VDD and IF matching required.
13	GND	DC and RF Ground
14	CELL IF OUT2	Cellular IF Out2. VDD and IF matching required.
15	CELL IF OUT1	Cellular IF Out1. VDD and IF matching required.
16	MODE SEL	Selects between Cellular IF Out1 and IF Out2
17	MODE SEL VDD	Mode Select Network Supply Voltage
18	CELL SRC	Parallel RC network determines the Cellular IFA Current, Gain and IIP3.
19	CELL VDD	Cellular Downconverter Supply Voltage. Must be RF bypassed.
20	CELL IFA IN	Cellular IFA Input

- **North America** Tel: 800.366.2266 / Fax: 978.366.2266
- **Europe** Tel: 44.1908.574.200 / Fax: 44.1908.574.300
- **Asia/Pacific** Tel: 81.44.844.8296 / Fax: 81.44.844.8298

Visit [www.macom.com](http://www.macom.com) for additional data sheets and product information.

M/A-COM Inc. and its affiliates reserve the right to make changes to the product(s) or information contained herein without notice. M/A-COM makes no warranty, representation or guarantee regarding the suitability of its products for any particular purpose, nor does M/A-COM assume any liability whatsoever arising out of the use or application of any product(s) or information.

Dual-Band/Triple-Mode Downconverter  
869 - 893 MHz and 1930 - 1990 MHz

MADCSM0001  
V2

**Cellular Band - Electrical Specifications:**

$T_A = 25^\circ\text{C}$ ,  $Z_0 = 50 \Omega$ ,  $V_{DD} = 3.0 \text{ V}$ ,  $\text{MODE\_SEL} = 0 \text{ V} / 3.0 \text{ V}$

RF Frequency = 880 MHz, LO Frequency = 965 MHz, IF Frequency = 85 MHz

Parameter	Test Conditions	Units	Min.	Typ.	Max.
LO Power	—	dBm	-10	-8	-5
Conversion Gain	LO = -8 dBm	dB	5	10	12
Noise Figure	LO = -8 dBm	dB	—	8	—
Input IP3	LO = -8 dBm	dBm	5	10	—
Return Loss	RF Port	dB	—	12	—
	LO Port	dB	—	25	—
	IF Port	dB	—	17	—
Isolation	LO to IF	dB	—	13	—
	RF to IF	dB	—	28	—
Current	LO = -8 dBm	mA	—	10	15

**PCS Band - Electrical Specifications:**

$T_A = 25^\circ\text{C}$ ,  $Z_0 = 50 \Omega$ ,  $V_{DD} = 3.0 \text{ V}$

RF Frequency = 1960 MHz, LO Frequency = 1750 MHz, IF Frequency = 210 MHz

Parameter	Test Conditions	Units	Min.	Typ.	Max.
LO Power	—	dBm	-10	-8	-5
Conversion Gain	LO = -8 dBm	dB	9.5	12	14.5
Noise Figure	LO = -8 dBm	dB	—	8	—
Input IP3	LO = -8 dBm	dBm	4	10	—
Return Loss	RF Port	dB	—	12	—
	LO Port	dB	—	15	—
	IF Port	dB	—	19	—
Isolation	LO to IF	dB	—	39	—
	RF to IF	dB	—	59	—
Current	LO = -8 dBm	mA	—	13	17

**Handling Procedures**

Please observe the following precautions to avoid damage:

**Static Sensitivity**

Gallium Arsenide Integrated Circuits are sensitive to electrostatic discharge (ESD) and can be damaged by static electricity. Proper ESD control techniques should be used when handling these devices.

**Dual-Band/Triple-Mode Downconverter**  
869 - 893 MHz and 1930 - 1990 MHz

MADCSM0001  
V2

**Sample Board Schematic**

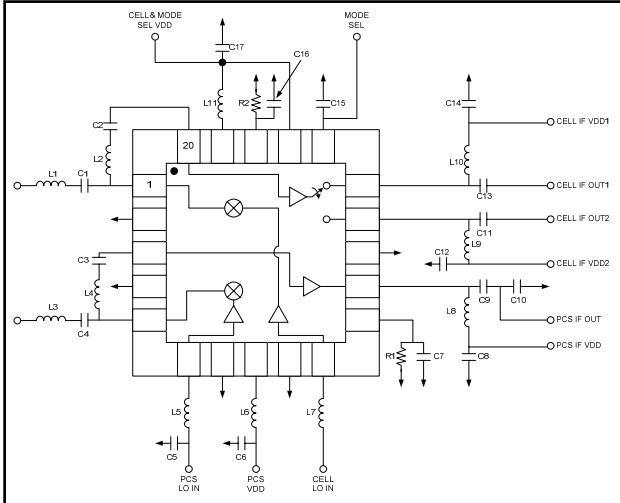

**Recommended PCB Configuration**

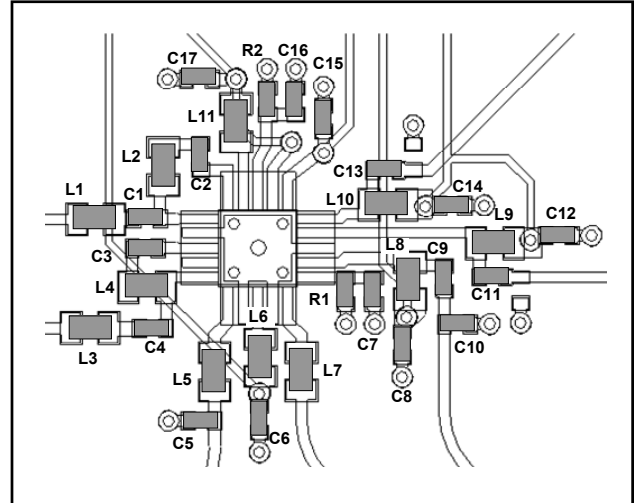

**External Circuitry Parts List**

Ref Designation	Value	Case Size	Purpose
C1	2.7 pF	0402	RF Matching
C2,C3	1000 pF	0402	RF/IF Bypass
C4	1 pF	0402	RF Matching
C5	2 pF	0402	RF Matching
C6,C7,C8,C12, C14,C15,C16,C17	0.1 µF	0402	RF/IF Bypass
C9	39 pF	0402	IF Matching
C10	12 pF	0402	IF Matching
C11,C13	33 pF	0402	IF Matching
L1,L11	22 nH	0603	RF Matching
L2	270 nH	0603	IF Matching
L3	6.8 nH	0603	RF Matching
L4	120 nH	0603	IF Matching
L5,L6	5.1 nH	0603	RF/IF Matching
L7	15 nH	0603	RF Matching
L8	33 nH	0603	IF Choke
L9,L10	150 nH	0603	IF Choke
R1	56 Ohms	0402	PCS Source Bias
R2	51 Ohms	0402	Cellular Source Bias

**Typical Performance Curves - Cellular Frequency Band, LO = -8 dBm, V<sub>DD</sub> = 3.0 V**

**Conversion Gain (IF1)**

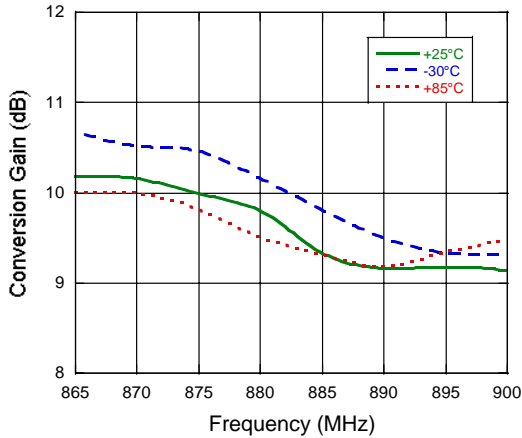

**Conversion Gain (IF2)**

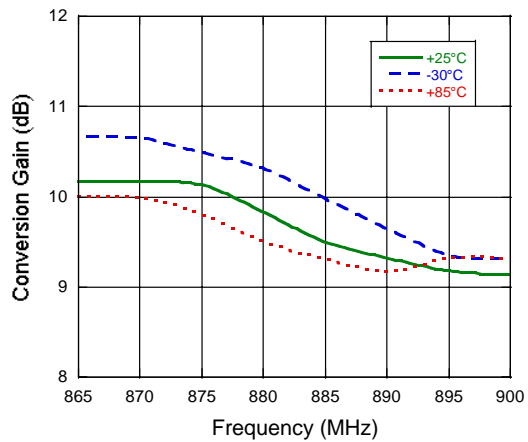

**Input IP3 (IF1)**

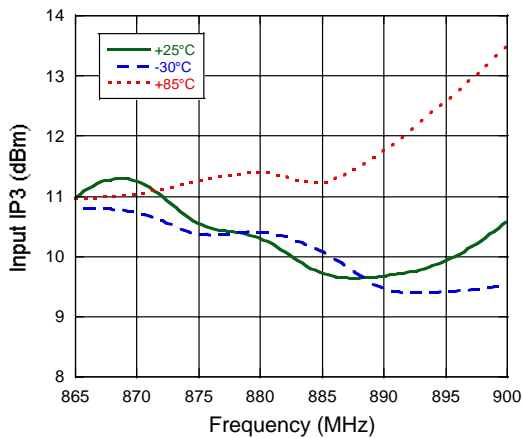

**Input IP3 (IF2)**

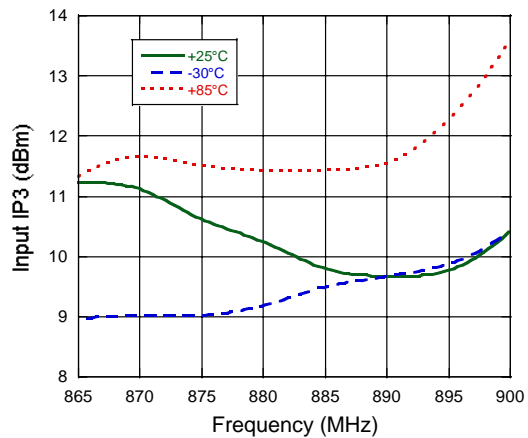

**Noise Figure (IF1)**

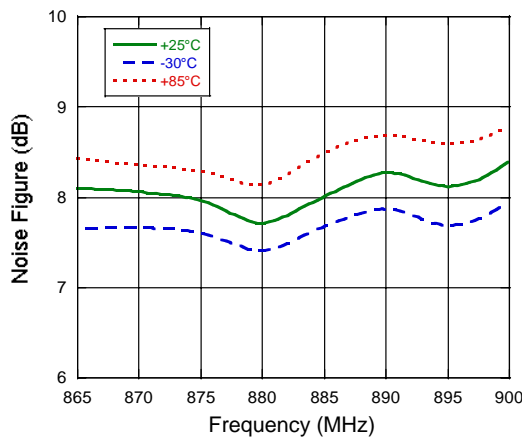

**Noise Figure (IF2)**

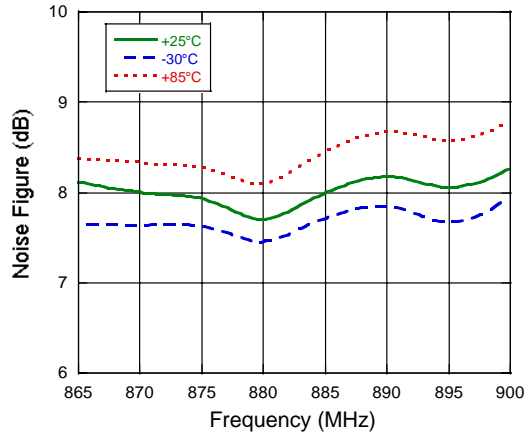

**Typical Performance Curves - Cellular Frequency Band, LO = -8 dBm, V<sub>DD</sub> = 3.0 V**

**LO to IF1 Isolation**

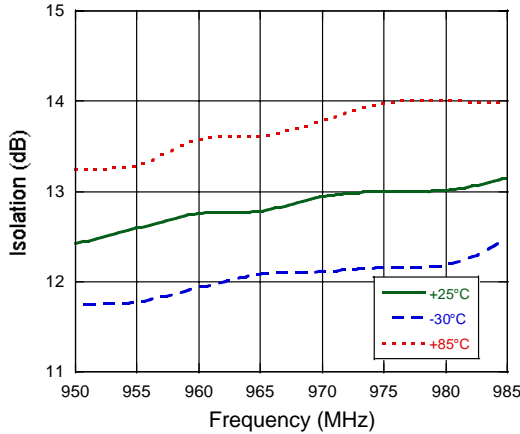

**LO to IF2 Isolation**

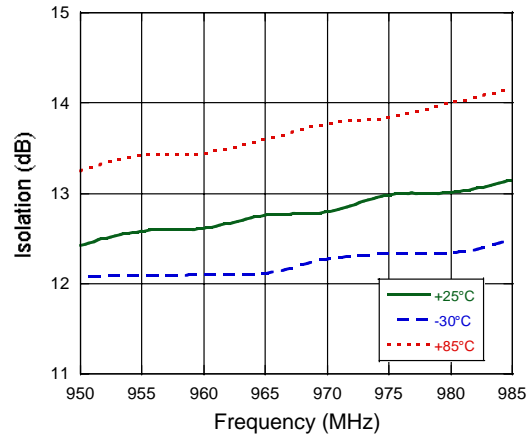

**RF to IF1 Isolation**

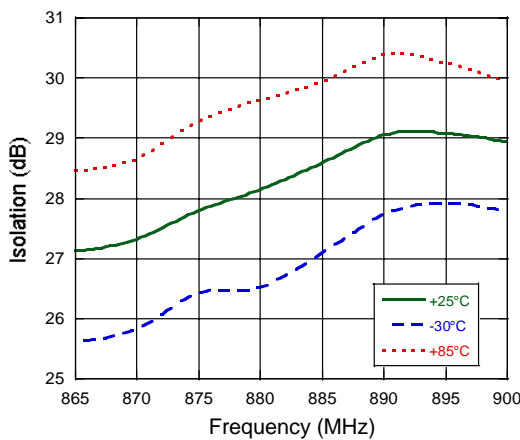

**RF to IF2 Isolation**

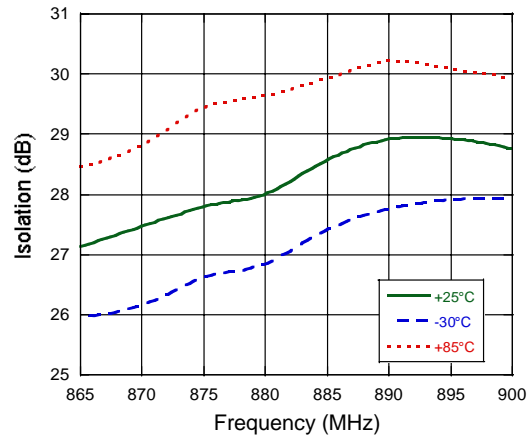

**Current (IF1)**

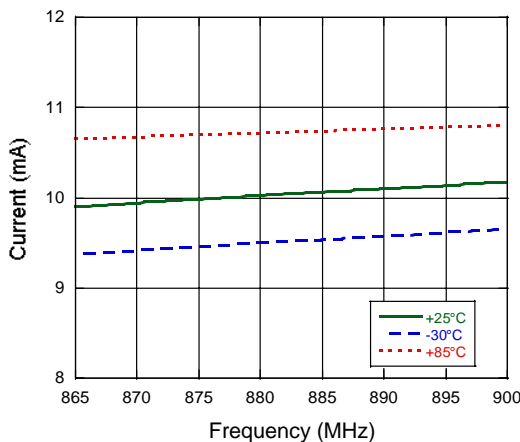

**Current (IF2)**

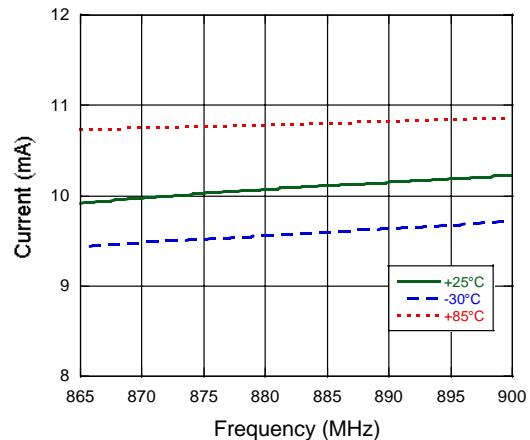

**Typical Performance Curves - Cellular Frequency Band, LO = -8 dBm, V<sub>DD</sub> = 3.0 V**

**LO Port Match**

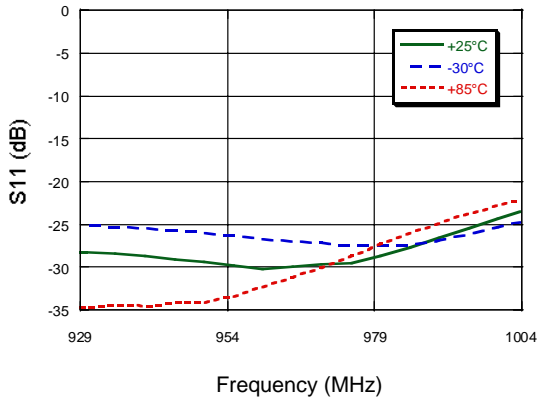

**RF Port Match**

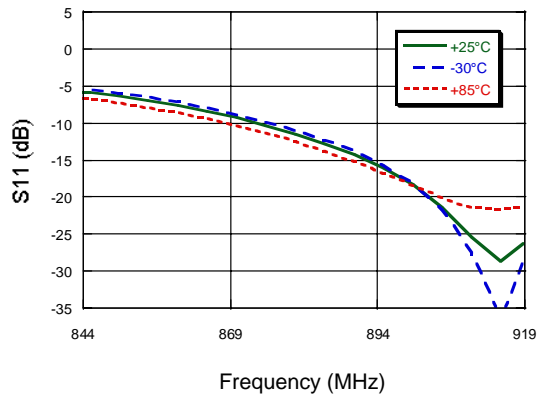

**IF1 Port Match**

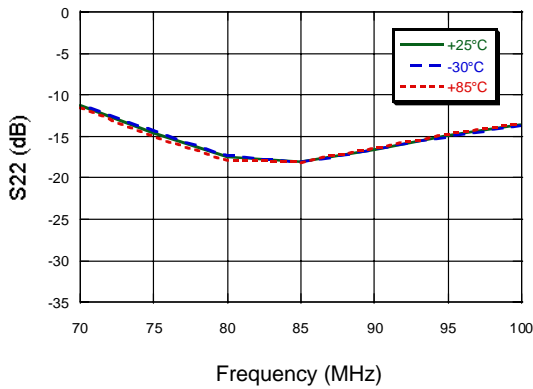

**IF2 Port Match**

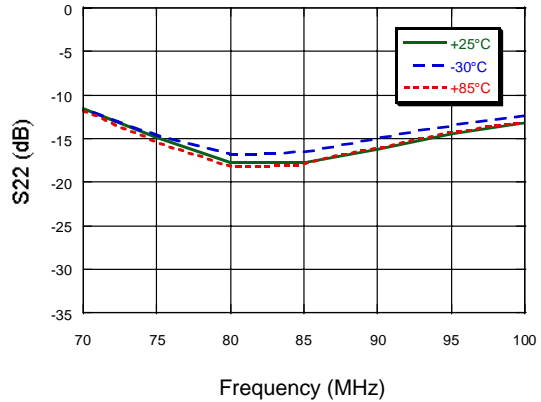

**Typical Performance Curves - PCS Frequency Band, LO = -8 dBm, V<sub>DD</sub> = 3.0 V**

**Conversion Gain**

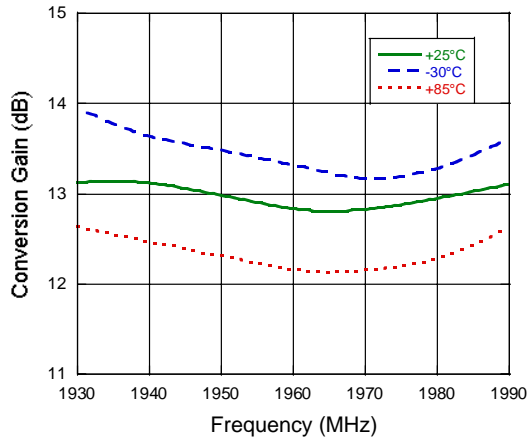

**Input IP3**

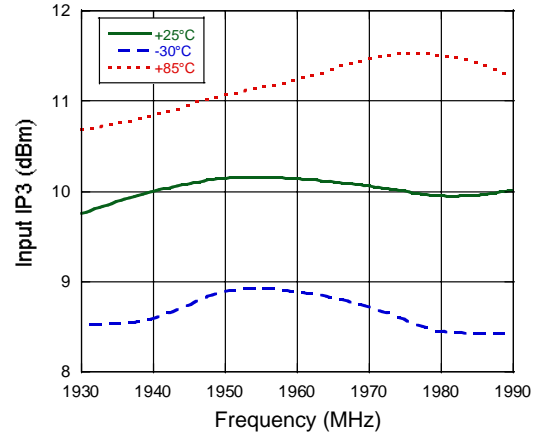

**Noise Figure**

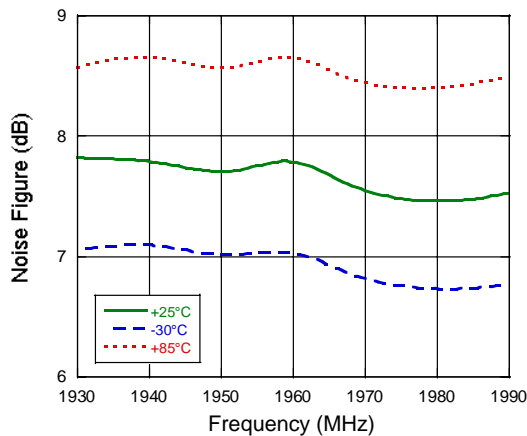

**LO to IF Isolation**

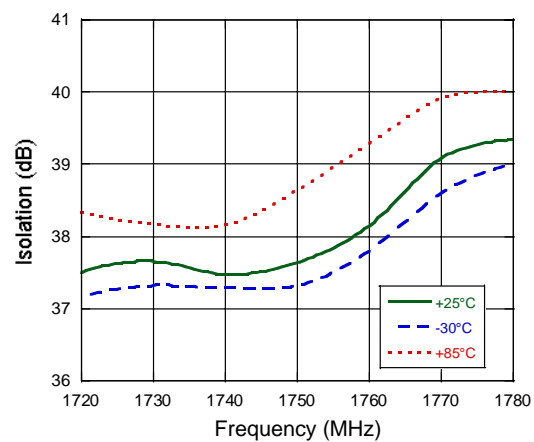

**RF to IF Isolation**

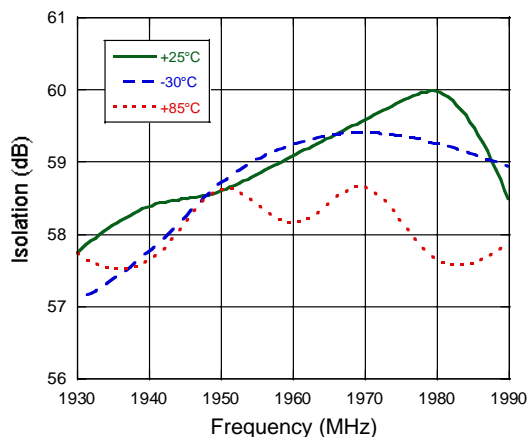

**Current**

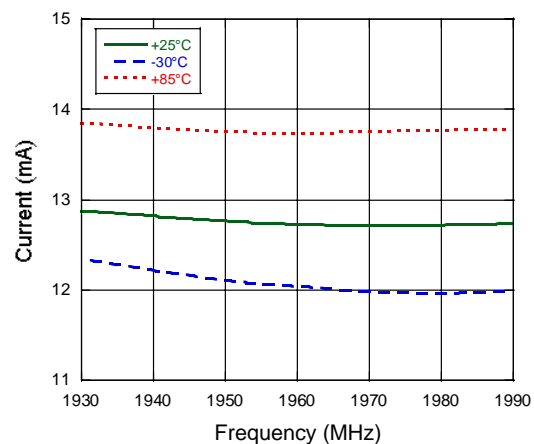

Dual-Band/Triple-Mode Downconverter  
869 - 893 MHz and 1930 - 1990 MHz

MADCSM0001  
V2

Typical Performance Curves - PCS Frequency Band, LO = -8 dBm, V<sub>DD</sub> = 3.0 V

LO Port Match

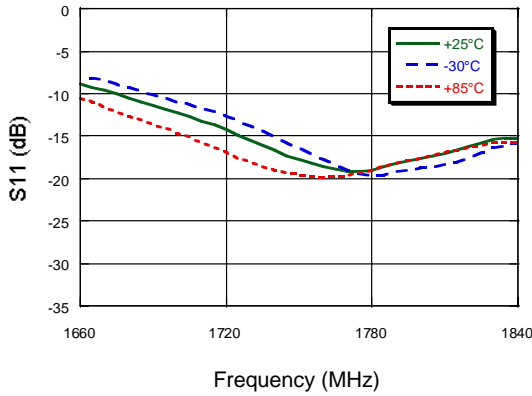

RF Port Match

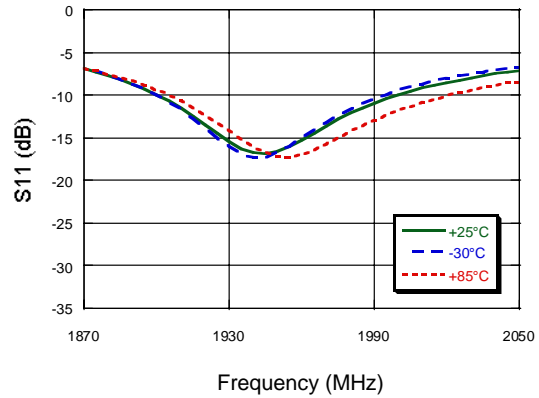

IF Port Match

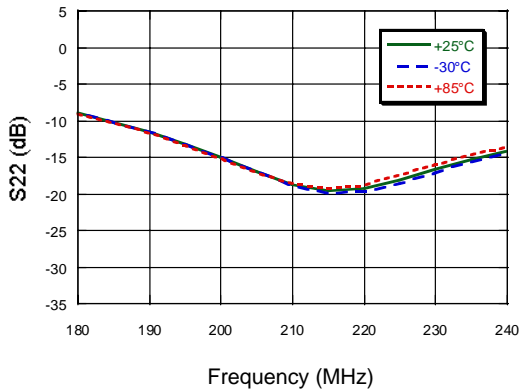

4 mm 20-Lead PQFN†

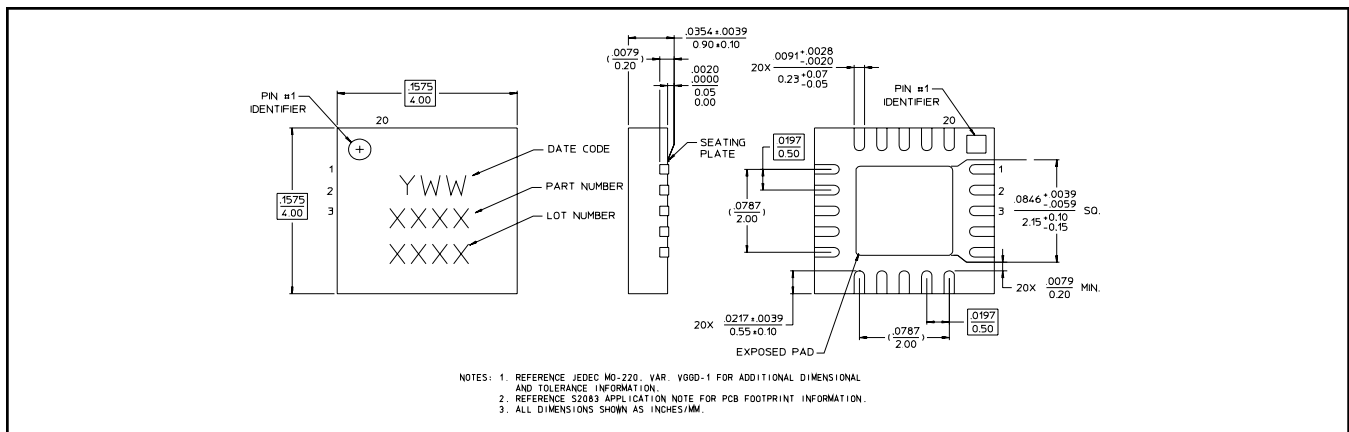

†Meets JEDEC moisture sensitivity level 1 requirements.