

Features

- High Drive Current Capability (± 50 mA)
- 27V Back Bias in Off State
- Switching Speed Approximately 1.5 μ s
- Low Current Consumption
- Land Grid Array Package for SMT Applications
- Tape and Reel Packaging Available
- Lead-Free Package
- 260°C Reflow Compatible
- RoHS* Compliant
- Single CMOS Logic input

Description

M/A-COM Technology Solutions MADR-008888-000100 Switch Driver is designed to work with M/A-COM Tech switch MASW-000823-12770T or other series / series switches. This driver is design to provide currents up to 50 mA for each diode in series / series switches. It is designed for SPDT switches that operate with a power range of approximately 5 – 20W CW. The driver is packaged in a Land Grid Array surface mount package and is available in tape and reel packaging for high volume applications. The MADR-008888-000100 driver is ideally suited for driving M/A-COM's line of HMIC switches.

Note that this driver will also operate when VDD is set to voltages other than +28V. It could also operate at +12V, +15V, +20V, and +24V supplies.

Ordering Information ¹

Part Number	Package
MADR-008888-000100	Bulk Packaging
MADR-008888-0001TR	300 piece Reel
MADR-008888-0001TB	Sample Board with Driver & MASW-000822-12770T Switch
MADR-008888-0002TB	Sample Board with Driver & MASW-000825-12770T Switch

1. Reference Application Note M513 for reel size information.
2. Exceeding any one or combination of these limits may cause permanent damage to this device.
3. M/A-COM does not recommend sustained operation near these survivability limits.

* Restrictions on Hazardous Substances, European Union Directive 2002/95/EC.

Pin Configuration

Pin No.	Pin Name	Pin No.	Pin Name
1	VCC (+5V)	13	GND
2	GND	14	NC
3	C1 (Logic)	15	GND
4	GND	16	TX Drive
5	VDD (+28V)	17	GND
6	GND	18	GND
7	GND	19	GND
8	GND	20	GND
9	GND	21	GND
10	RX Drive	22	GND
11	GND	23	GND
12	NC	-	-

Absolute Maximum Ratings ^{2,3}

Parameter	Absolute Maximum
VCC (+5V)	-0.5V to +6.5V
VDD (+28V)	-0.5V to 40V
C1 (Logic)	-0.5V to 6.5 V
RX Drive Current	60 mA
TX Drive Current	60 mA
Power Dissipation in Still Air	100 mW
Operational Temperature	-40 to +85°C
Storage Temperature	-55 to +125°C

Truth Table (Switch)

Control Input	Condition of Switch	
	RF Common to Each RF Port	
C1	TX	RX
0	Off	On
1	On	Off

ADVANCED: Data Sheets contain information regarding a product M/A-COM Technology Solutions is considering for development. Performance is based on target specifications, simulated results, and/or prototype measurements. Commitment to develop is not guaranteed.
PRELIMINARY: Data Sheets contain information regarding a product M/A-COM Technology Solutions has under development. Performance is based on engineering tests. Specifications are typical. Mechanical outline has been fixed. Engineering samples and/or test data may be available. Commitment to produce in volume is not guaranteed.

• **North America** Tel: 800.366.2266 • **Europe** Tel: +353.21.244.6400
 • **India** Tel: +91.80.43537383 • **China** Tel: +86.21.2407.1588
 Visit www.macomtech.com for additional data sheets and product information.

M/A-COM Technology Solutions Inc. and its affiliates reserve the right to make changes to the product(s) or information contained herein without notice.

Electrical Specifications: $T_A = +25^\circ\text{C}$, $+VCC = +5.0\text{ V}$, $VDD = +28\text{ V}$

Parameter	Test Conditions	Unit	Min	Typ	Max
DC Output Current RX Current ⁴ TX Current ⁴	Assumes 1V Drop on PIN Diode Assumes 1V Drop on PIN Diode	mA mA	— —	22 or 35 22 or 35	50 50
Back Bias Voltage on TX Diode RX Diode	RX ON TX ON	V V	— —	27 27	— —
Switching Speed: ANT-TX ⁵ Ton Toff Trise Tfall	50% CTL to 90% Voltage 50% CTL to 10% Voltage 10% - 90% 90% - 10%	μs μs ns ns	— — — —	0.9 1.5 250 300	2.0 ⁶ 2.0 ⁶ — —
Switching Speed: ANT-RX ⁵ Ton Toff Trise Tfall	50% CTL to 90% Voltage 50% CTL to 10% Voltage 10% - 90% 90% - 10%	μs μs ns ns	— — — —	1.5 0.9 200 250	2.0 ⁶ 2.0 ⁶ — —
PRF	50% duty cycle	KHz	DC	—	50
Quiescent Supply Currents	VCC (+5V) VDD (+28V)	mA mA	— —	— —	0.1 5.0
Logic Levels	Logic "0" @ 20 μA sink current Logic "1" @ 0.5 mA source current	V V	0.0 3.5	0.0 5.0	1.5 5.0
Supply Currents ⁴ ICC IDD	R1 = 80 Ω R1 = 110 Ω R1 = 180 Ω R1 = N/A	mA mA mA mA	— — — —	51 36 23 2.5	— — — —

- Currents are user selectable. Reference "Driver and SPDT Schematic" for suggested values. R1 should be ≥ 80 ohms for VCC= 5.0V. R1 should be ≥ 65 ohms for VCC = 3.3V.
- Switch parameters were measured when driving the MASW-000823-12770T switch.
- Maximums are for load currents up to 25mA

Recommended Operating Conditions

Parameter	Test Conditions	Unit	Min	Typ	Max
VCC	Nominal VCC = 3.3 V Nominal VCC = 5.0 V	V V	3.0 4.5	3.3 5.0	3.6 5.5
VDD	Input Voltage	V	27.0	28.0	29.0
C1 (Low Level Input Voltage)	VCC = 3.0 V to 3.6V VCC = 4.5 V to 5.5 V	V V	0.0 0.0	0.0 0.0	0.8 0.3 x VCC
C1 (High Level Input Voltage)	VCC = 3.0 V to 3.6V VCC = 4.5 V to 5.5 V	V V	2 0.7 x VCC	VCC VCC	VCC VCC

Handling Procedures

Please observe the following precautions to avoid damage:

Static Sensitivity

Silicon Circuits are sensitive to electrostatic discharge (ESD) and can be damaged by static electricity. Proper ESD control techniques should be used when handling these devices.

Typical Performance Curves

TX On, 20 mA Load Current

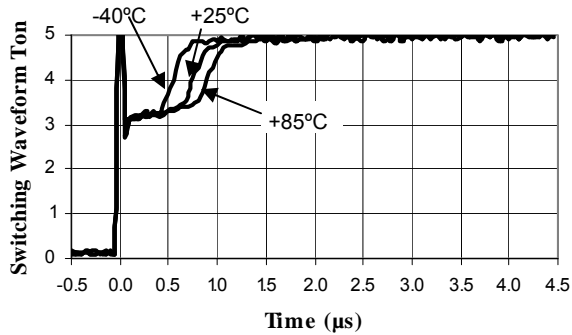

TX On, 50 mA Load Current

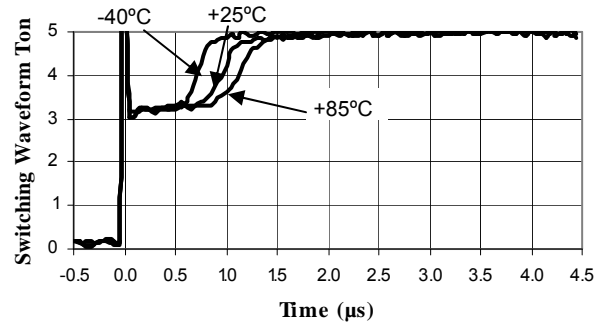

TX Off, 20 mA Load Current

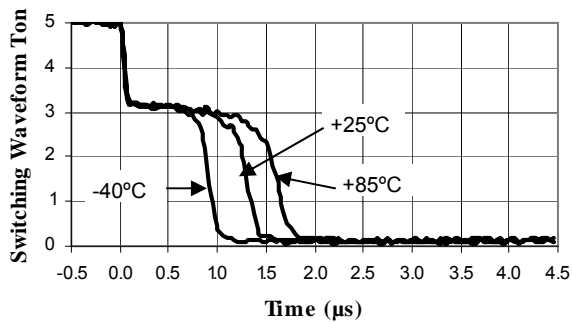

TX Off, 50 mA Load Current

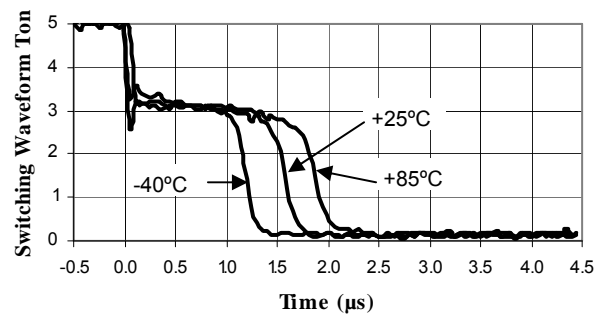

RX On, 20 mA Load Current

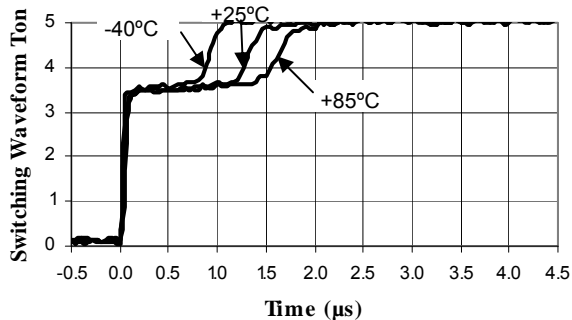

RX On, 50 mA Load Current

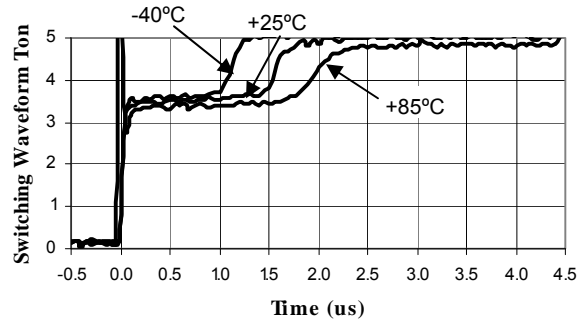

RX Off, 20 mA Load Current

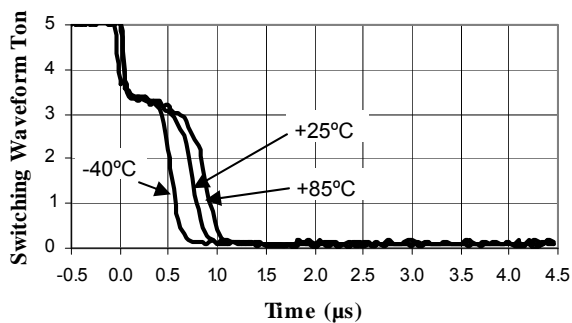

RX Off, 50 mA Load Current

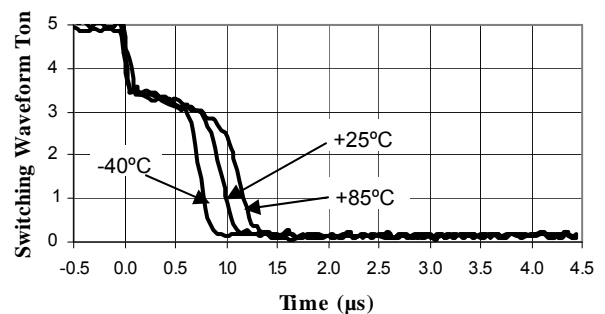

Driver and SPDT Schematic with +5V & +28V DC Power ^{7,8,9,10,11,12,13,14}

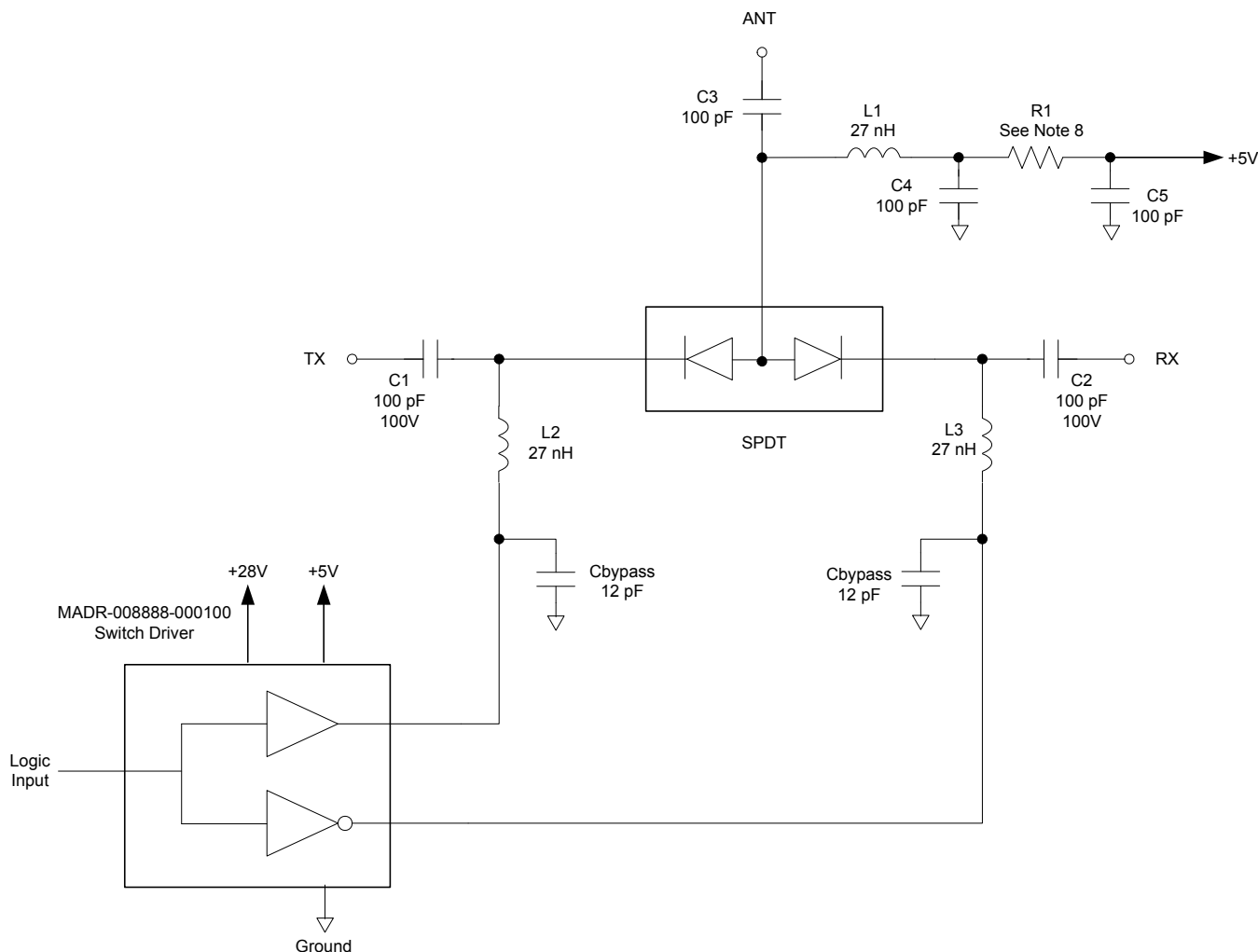

7. Forward Bias Diode Voltage: ΔV_f is 0.9V @ 22 mA; ΔV_f is 1.0V @ 35 mA
8. For 22 mA load current, R1 = 180 Ω @ VCC = 5.0V and 105 Ω @ VCC = 3.3V. For 35 mA load current, R1 = 110 Ω @ VCC = 5.0V and 165 Ω @ VCC = 3.3V. Nominal power dissipation in the 180 Ω and 110 Ω resistors are 87 mW and 135 mW.
9. Reverse Bias is ~ 27V (This is the 28V supply minus approximately 1V on the diode).
10. M/A-COM PIN Diode Driver, MADR-008888-0001TR is recommended for usage with the MASW-000823-12770T SPDT Switch.
11. The voltage at the common anode will be approximately 1.0V.
12. The current in through the back-biased diodes will be the leakage current for the diodes
13. C1-C5, L1-L3, R1, and the switch are discrete components that should be installed on the user's board. It is recommended that Coilcraft 0603CS-27NXJLW or equivalent be used for L1-L3 at 2 GHz (values may vary based on the frequency).
14. There are 33 pF bypass capacitors included in the driver for the RX and TX ports. There are cases, especially at higher frequencies, where the optional 12 pF bypass capacitors that are shown on the schematic are needed.

Lead-Free Land Grid Array, 0.64 in x 0.84 in †

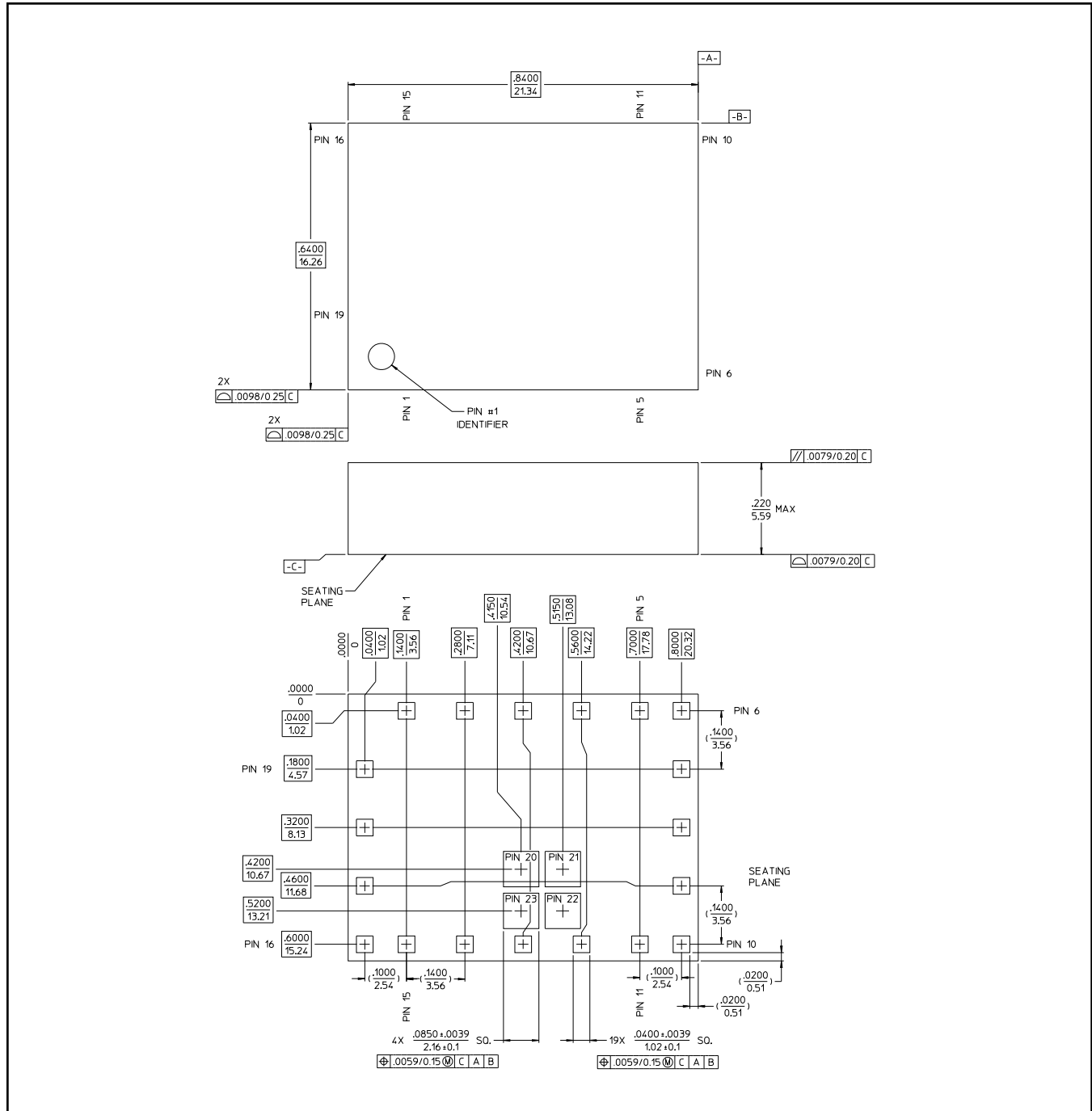

† Reference Application Note M538 for lead-free solder reflow recommendations.
Meets JEDEC moisture sensitivity level 1 requirements.

5

ADVANCED: Data Sheets contain information regarding a product M/A-COM Technology Solutions is considering for development. Performance is based on target specifications, simulated results, and/or prototype measurements. Commitment to develop is not guaranteed.
PRELIMINARY: Data Sheets contain information regarding a product M/A-COM Technology Solutions has under development. Performance is based on engineering tests. Specifications are typical. Mechanical outline has been fixed. Engineering samples and/or test data may be available. Commitment to produce in volume is not guaranteed.

• **North America** Tel: 800.366.2266 • **Europe** Tel: +353.21.244.6400
• **India** Tel: +91.80.43537383 • **China** Tel: +86.21.2407.1588
Visit www.macomtech.com for additional data sheets and product information.

M/A-COM Technology Solutions Inc. and its affiliates reserve the right to make changes to the product(s) or information contained herein without notice.