

**Released**

# X-band Magnetron

## Model No. MAF1421B

**Copyright©****Nisshinbo Micro Devices Inc.  
Microwave Business Headquarters**

-Notice of Proprietary Information-

This document and its contents are proprietary to Nisshinbo Micro Devices Inc.  
This publication and its contents may not be reproduced or distributed for any other purpose  
without the written permission of Nisshinbo Micro Devices Inc.  
Those specifications listed in this document are subject to change at any time.

## ■ GENERAL DESCRIPTION

MAF1421B is designed for the magnetron of X-band radar system. The frequency range is fixed <9380 - 9440MHz> and the peak output power is 4kW.



## ■ ELECTRICAL CHARACTERISTICS

PARAMETERS	MINIMUM	TYPICAL	MAXIMUM	UNITS
Heater voltage (note 1)	5.7	6.3	6.9	V
Heater current	0.5	0.55	0.6	A
Preheat time	60	-	-	s
Peak anode voltage (note 2)	3.4	3.6	3.8	kV
Peak output power (note 2)	3.6	4.0	-	kW
Frequency (note 2)	9380	9410	9440	MHz

## ■ ABSOLUTE MAXIMUM RATINGS

These ratings cannot necessarily be used simultaneously and no individual ratings should be exceeded.

PARAMETERS	MINIMUM	MAXIMUM	UNITS
Peak anode current (note 3)	2.0	4.0	A
Average anode power input	-	13	W
Duty cycle	-	0.001	-
Pulse duration	0.05	1.0	μs
Rate of rise of voltage pulse	-	70	kV/μs
Anode temperature	-	100	°C
VSWR at the output coupler	-	1.5 : 1	-

### Notes

1. With no anode input power. No reduction of heater voltage at operating is required.
2. Measured at peak anode current 3.0A.
3. Any overshoot of the anode current is not acceptable. And, sagging waveform of the anode current causes the poor spectrum and the shifting frequency in the pulse since a magnetron current pushing characteristics.

\*Above Specifications are subject to change without notice.

## ■ OUTLINE

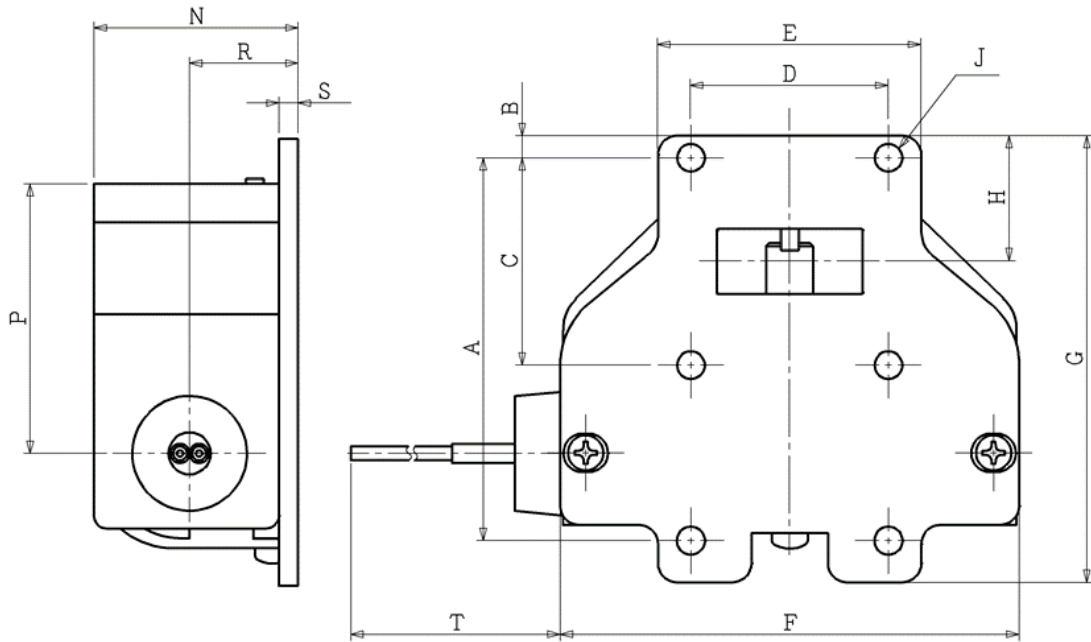

Anode temperature measured at this point

DEMENSIONS Unit:mm

A	60±0.2	K	2-φ4.4±0.1
B	3.75	L	9
C	32.5±0.1	M	7
D	31±0.1	N	33MAX
E	41.3	P	43
F	72	R	17
G	70	S	3
H	20	T	185±10
J	4-φ4.32±0.08		

Lead Connections

Colour	Element
Green	Heater
Yellow	Heater, Cathode

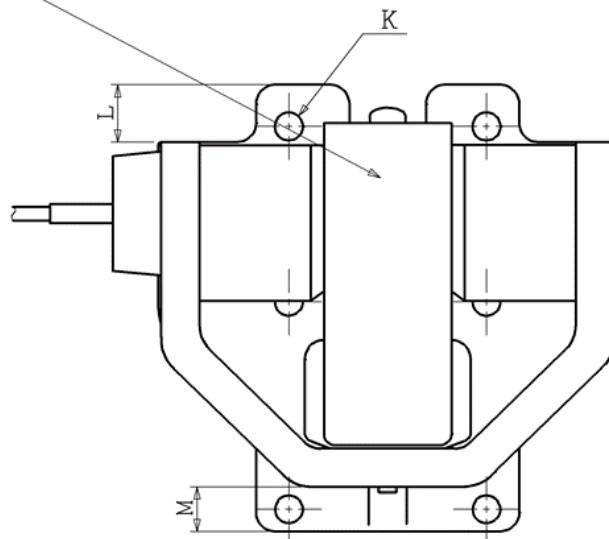

Top view

(Dimensions are expressed in "mm".)

\* Above Specifications are subject to change without notice.

