

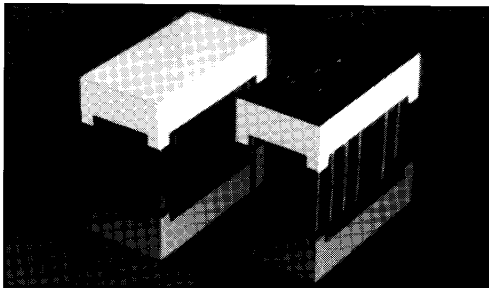

**0.300-INCH
SEVEN SEGMENT DISPLAYS**

**HIGH EFFICIENCY GREEN MAN3480A
ORANGE MAN3680A**

**RED MAN78A
YELLOW MAN3880A
HIGH EFFICIENCY RED MAN3980A**



DESCRIPTION

The MAN3480A, MAN3680A, MAN78A, MAN3880A and MAN3980A are common cathode displays which provide a choice of color of LED displays. They are pin and functional replacements for the 0.300-inch Hewlett-Packard common cathode displays. The series is complementary to the MAN3400A, MAN3600A, MAN70A, MAN3800A and MAN3900A families of displays. They can be mounted in arrays with 0.400-inch (10.16 mm) center-to-center spacing. Yellow and High Efficiency Green displays are constructed with Grey face and neutral segment color. Red displays have Black faces and Red segment color. Others have face and segment color corresponding to the emitted light.

FEATURES

- Hewlett-Packard compatible common cathode displays
- Red, Yellow, Green, Orange and High Efficiency Red
- Fast switching — excellent for multiplexing
- Low power consumption
- Bold solid segments that are highly legible
- Solid state reliability — long operation life
- Impact resistant plastic construction
- Directly compatible with integrated circuits
- High brightness with high contrast
- Categorized for Luminous Intensity (See Note 6)
- Standard 10 pin dual-in-line package configuration
- Wide viewing angle...150°

APPLICATIONS

- Digital readout displays
- Instrument panels
- Point of sale terminals
- Calculators
- Digital clocks

MODEL NUMBERS

PART NO.	COLOR	DESCRIPTION
MAN3480A	High Efficiency Green	Common Cathode; Right Hand Decimal
MAN3680A	Orange	Common Cathode; Right Hand Decimal
MAN78A	Red	Common Cathode; Right Hand Decimal
MAN3880A	Yellow	Common Cathode; Right Hand Decimal
MAN3980A	High Efficiency Red	Common Cathode; Right Hand Decimal



0.300-INCH SEVEN SEGMENT DISPLAYS

RECOMMENDED OPTICAL FILTERS			
For optimum ON and OFF contrast, one of the following filters or equivalents should be used over the display:			
DEVICE TYPE	FILTER	DEVICE TYPE	FILTER
MAN3480A	Panelgraphic Green 48 Homalite 100-1440 Green	MAN3980A MAN78A	Panelgraphic Red 60 Homalite 100-1605
MAN3680A	Panelgraphic Scarlet 65 Homalite 100-1670	MAN3880A	Panelgraphic Yellow 25 or Amber 23 Homalite 100-1720 or 100-1726 Panelgraphic Grey 10 Homalite 100-1266 Grey

ELECTRO-OPTICAL CHARACTERISTICS (25°C Free Air Temperature Unless Otherwise Specified)					
	MIN.	TYP.	MAX.	UNITS	TEST CONDITIONS
MAN3480A					
Luminous Intensity, digit average (See Notes 1 and 3)	750 900	3200 4000		μ cd μ cd	$I_f=10$ mA $I_f=60$ mA peak, 1:6 DF
Peak emission wavelength		562		nm	
Spectral line half width		30		nm	
Forward voltage					
Segment		2.2	3.0	V	$I_f=20$ mA
Decimal point		2.2	3.0	V	$I_f=20$ mA
Dynamic resistance					
Segment		12		Ω	$I_f=20$ mA
Decimal point		12		Ω	$I_f=20$ mA
Capacitance					
Segment		40		pF	V=0
Decimal point		40		pF	V=0
Reverse current					
Segment			100	μ A	$V_R=5.0$ V
Decimal point			100	μ A	$V_R=5.0$ V
MAN3680A					
Luminous Intensity, digit average (See Note 1 and 3)	510	1800		μ cd	$I_f=10$ mA
Peak emission wavelength		630		nm	
Spectral line half width		40		nm	
Forward voltage					
Segment			2.5	V	$I_f=20$ mA
Decimal point			2.5	V	$I_f=20$ mA
Dynamic resistance					
Segment		26		Ω	$I_f=20$ mA
Decimal point		26		Ω	$I_f=20$ mA
Capacitance					
Segment		35		pF	V=0
Decimal point		35		pF	V=0
Reverse current					
Segment			100	μ A	$V_R=5.0$ V
Decimal point			100	μ A	$V_R=5.0$ V



0.300-INCH SEVEN SEGMENT DISPLAYS

ELECTRO-OPTICAL CHARACTERISTICS (25°C Free Air Temperature Unless Otherwise Specified) (Cont'd)						
	MIN.	TYP.	MAX.	UNITS	TEST CONDITIONS	
MAN78A						
Luminous Intensity, digit average (See Note 1 and 3)	125	350		μcd	$I_f = 10 \text{ mA}$	
Peak emission wavelength		660		nm		
Spectral line half width		20		nm		
Forward voltage						
Segment			2.0	V	$I_f = 20 \text{ mA}$	
Decimal point			2.0	V	$I_f = 20 \text{ mA}$	
Dynamic resistance						
Segment		2		Ω	$I_{pk} = 100 \text{ mA}$	
Decimal point		2		Ω	$I_{pk} = 100 \text{ mA}$	
Capacitance						
Segment		35	80	pF	$V = 0$	
Decimal point		35	80	pF	$V = 0$	
Reverse current						
Segment			100	μA	$V_R = 5.0 \text{ V}$	
Decimal point			100	μA	$V_R = 5.0 \text{ V}$	
MAN3880A						
Luminous Intensity, digit average (See Note 1 and 3)	450	1700		μcd	$I_f = 10 \text{ mA}$	
Peak emission wavelength		585		nm		
Spectral line half width		40		nm		
Forward voltage						
Segment			3.0	V	$I_f = 20 \text{ mA}$	
Decimal point			3.0	V	$I_f = 20 \text{ mA}$	
Dynamic resistance						
Segment		26		Ω	$I_f = 20 \text{ mA}$	
Decimal point		26		Ω	$I_f = 20 \text{ mA}$	
Capacitance						
Segment		35		pF	$V = 0$	
Decimal point		35		pF	$V = 0$	
Reverse current						
Segment			100	μA	$V_R = 5.0 \text{ V}$	
Decimal point			100	μA	$V_R = 5.0 \text{ V}$	
MAN3980A						
Luminous Intensity, digit average (See Note 1 and 3)	450	1900		μcd	$I_f = 10 \text{ mA}$	
Peak emission wavelength		635		nm		
Spectral line half width		40		nm		
Forward voltage						
Segment			2.5	V	$I_f = 20 \text{ mA}$	
Decimal point			2.5	V	$I_f = 20 \text{ mA}$	
Dynamic resistance						
Segment		26		Ω	$I_f = 20 \text{ mA}$	
Decimal point		26		Ω	$I_f = 20 \text{ mA}$	
Capacitance						
Segment		35		pF	$V = 0$	
Decimal point		35		pF	$V = 0$	
Reverse current						
Segment			100	μA	$V_R = 5.0 \text{ V}$	
Decimal point			100	μA	$V_R = 5.0 \text{ V}$	



0.300-INCH SEVEN SEGMENT DISPLAYS

ABSOLUTE MAXIMUM RATINGS			
	HIGH EFF. GREEN	RED	ORANGE YELLOW HIGH EFF. RED
	MAN3480A	MAN78A	MAN3680A MAN3680A MAN3980A
Power dissipation at 25°C ambient	600 mW	480 mW	600 mW
Derate linearly from 50°C.	-12 mW/°C	-6.9 mW/°C	-10.3 mW/°C
Storage and operating temperature	-40°C to +85°C	-40°C to +85°C	-40°C to +85°C
Continuous forward current			
Total	240 mA	240 mA	200 mA
Per segment.	30 mA	30 mA	25 mA
Decimal point.	30 mA	30 mA	25 mA
Reverse voltage			
Per segment.	6.0 V	6.0 V	6.0 V
Decimal point.	6.0 V	6.0 V	6.0 V
Soldering time at 260°C (See Notes 4 and 5).	5 sec.	5 sec.	5 sec.

TYPICAL THERMAL CHARACTERISTICS	
GREEN/YELLOW	
Thermal resistance junction to free air Φ_{JA}	160°C/W
Wavelength temperature coefficient (case temperature)	1.0Å/°C
Forward voltage temperature coefficient	-1.5 mV/°C
RED/ORANGE/HIGH EFFICIENCY RED	
Thermal resistance junction to free air Φ_{JA}	160°C/W
Wavelength temperature coefficient (case temperature)	1.0Å/°C
Forward voltage temperature coefficient	-2.0 mV/°C

- | NOTES |
|-------------------------------------------------------------------------------------------------------------------------------------------------------------------------------------------------------------------------------------------------------------------------------------------------------------------------------------------------------------------------------------------------------------------------------------------------------------------------------------------------------------------------------------------------------------------------------------------------------------------------------------------------------------------------------------------------------------------------------------------------------------------------------------------------------------------------------------------------------------------------------------------------------------------------------------------------------------------------------------------------------------------------------------------------------------------------------------------------------------------------------------------------------------------|
| <ol style="list-style-type: none"> 1. The digit average Luminous Intensity is obtained by summing the Luminous Intensity of each segment and dividing by the total number of segments. Intensity will not vary more than $\pm 33.3\%$ between all segments within a digit. 2. The curve in Figures 3, 6, 9, and 12 is normalized to the brightness at 25°C to indicate the relative Luminous Intensity over the operating temperature range. 3. The decimal point is designed to have the same surface brightness as the segments, therefore, the Luminous Intensity of the decimal point is .3 times the Luminous Intensity of the segments, since the area of the decimal point is .3 times the area of the average segment. 4. Leads of the device immersed to 1/16 inch from the body. Maximum device surface temperature is 140°C. 5. For flux removal, Freon TF, Freon TE, Isoproponal or water may be used up to their boiling points. 6. All displays are categorized for Luminous Intensity. The Intensity category is marked on each part as a suffix letter to the part number. |

PACKAGE DIMENSIONS

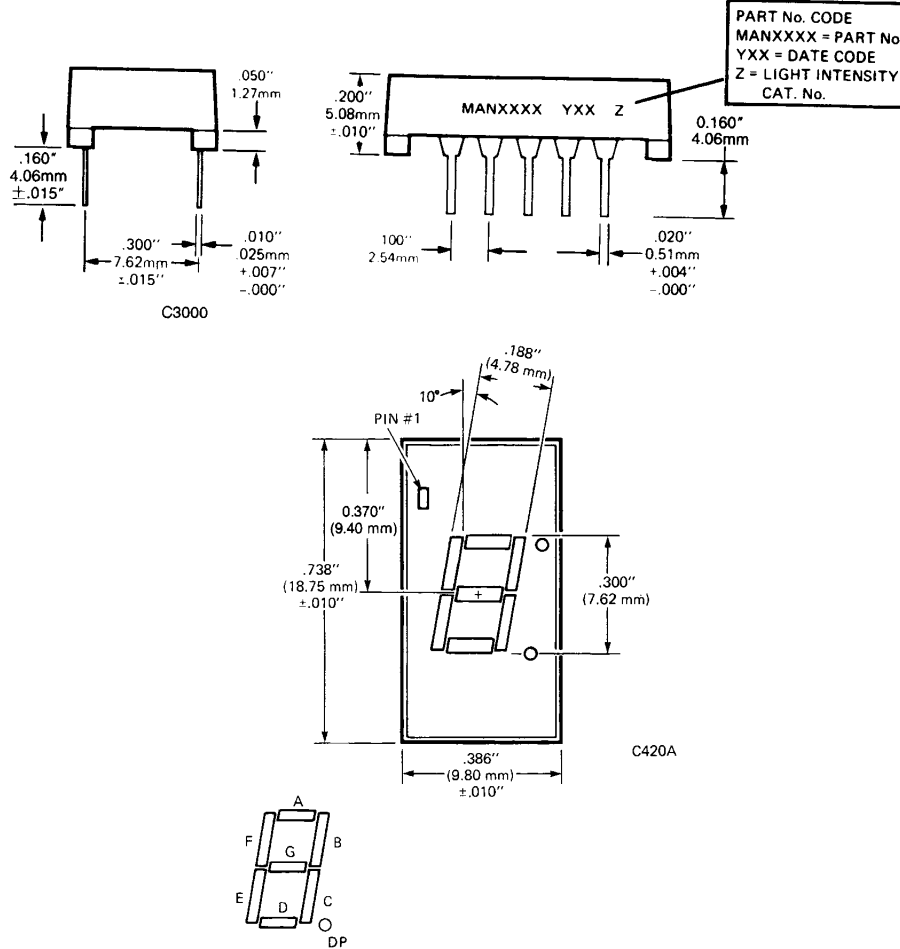

ELECTRICAL CONNECTIONS

PIN NO.	ELECTRICAL CONNECTIONS
1	Common Cathode
2	Anode F
3	Anode G
4	Anode E
5	Anode D
6	Common Cathode
7	Anode D.P.
8	Anode C
9	Anode B
10	Anode A

TYPICAL CHARACTERISTIC CURVES

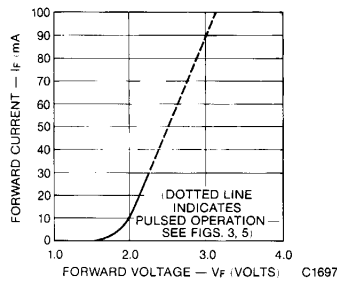

Fig. 1. Forward Current vs. Forward Voltage

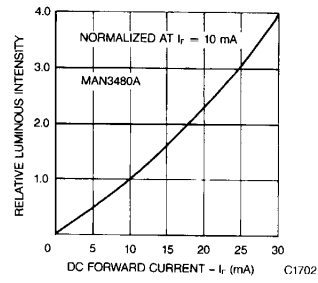

Fig. 2. Relative Luminous Intensity vs. DC Forward Current

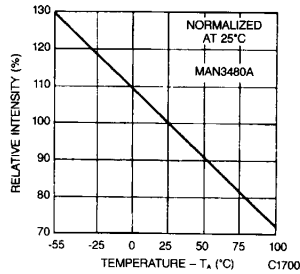

Fig. 3. Relative Luminous Intensity vs. Temperature

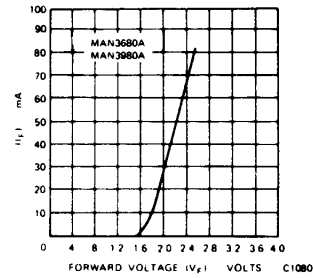

Fig. 4. Forward Current vs. Forward Voltage

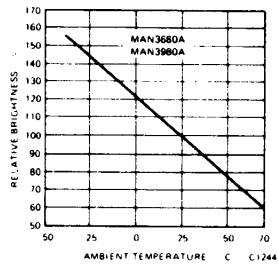

Fig. 5. Relative Luminous Intensity vs. Temperature

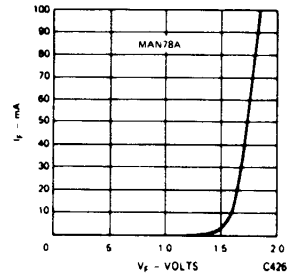

Fig. 6. Forward Current vs. Forward Voltage

TYPICAL CHARACTERISTIC CURVES (Cont'd)

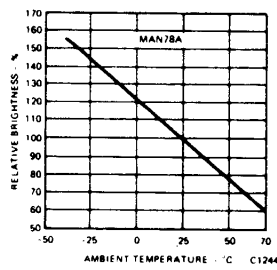

Fig. 7. Relative Luminous Intensity vs. Temperature

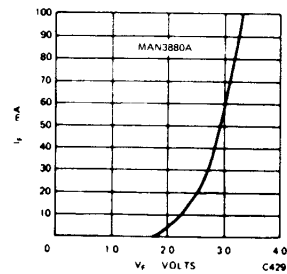

Fig. 8. Forward Current vs. Forward Voltage

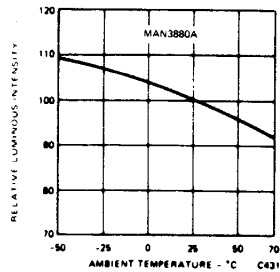

Fig. 9. Relative Luminous Intensity vs. Temperature

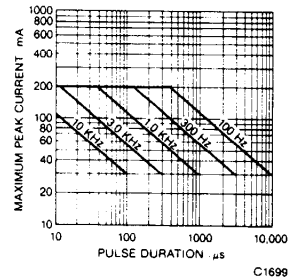

Fig. 10. Maximum Peak Current vs. Pulse Duration

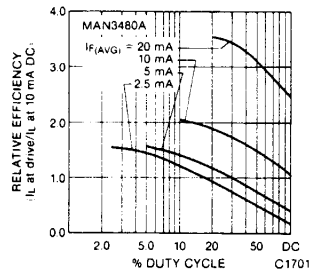

Fig. 11. Relative Efficiency vs. Duty Cycle

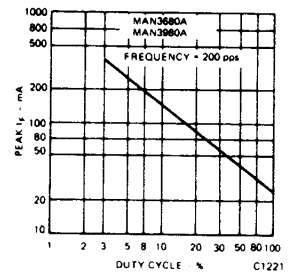

Fig. 12. Max Peak Current vs. Duty Cycle

TYPICAL CHARACTERISTIC CURVES (Cont'd)

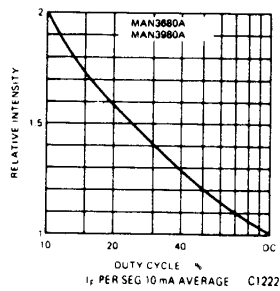

Fig. 13. Luminous Intensity vs. Duty Cycle

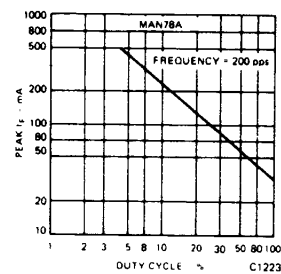

Fig. 14. Max Peak Current vs. Duty Cycle

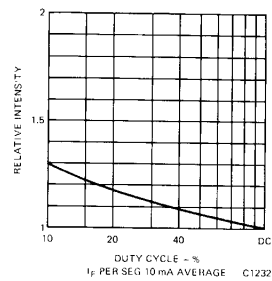

Fig. 15. Luminous Intensity vs. Duty Cycle

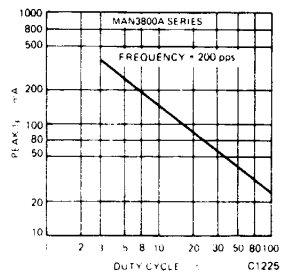

Fig. 16. Max Peak Current vs. Duty Cycle

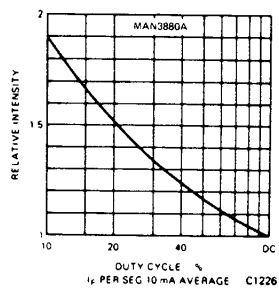

Fig. 17. Luminous Intensity vs. Duty Cycle

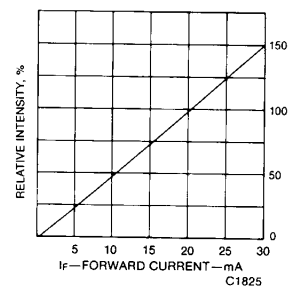

Fig. 18. Relative Luminous Intensity vs. Forward Current