

2.3-4.1 GHz Phase Shifter

MAPCGM0003-DIE

RO-P-DS-3045 A  
Preliminary Information

**Features**

- ◆ 6 Bit Phase Shifter (0° ~ 354°, CW)
- ◆ TTL Control Inputs
- ◆ MSAG™ Process

**Description**

The MAPCGM0003-Die is a 6-bit Phase Shifter with Parallel Input Control. This product is fully matched to 50 ohms on both the input and output. It can be used to obtain a phase shift of 5.6° to 354° Clockwise.

Fabricated using M/A-COM's repeatable, high performance and highly reliable GaAs Multifunction Self-Aligned Gate MESFET Process, each device is 100% RF tested on wafer to ensure performance compliance.

M/A-COM's MSAG™ process features robust silicon-like manufacturing processes, planar processing of ion implanted transistors, multiple implant capability enabling power, low-noise, switch and digital FETs on a single chip, and polyimide scratch protection for ease of use with automated manufacturing processes. The use of refractory metals and the absence of platinum in the gate metal formulation prevents hydrogen poisoning when employed in hermetic packaging.

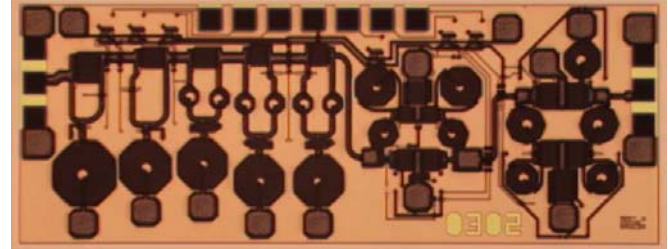

**Primary Applications**

- ◆ Satellite Communication
- ◆ Phased Array Radar

**Electrical Characteristics:  $T_B = 40^\circ\text{C}^1$ ,  $Z_0 = 50\Omega$ ,  $V_{EE} = -5\text{V}$**

Parameter	Symbol	Typical	Units
Bandwidth	f	2.3-4.1	GHz
Insertion Loss	IL	5.7	dB
Input VSWR (At Reference)	VSWR	1.5:1	
Output VSWR (At Reference)	VSWR	1.2:1	
RMS Phase Error	RMS	6	°
Phase Range	$\Delta\Phi$	354	°
Gain Variation over all Phase Shifter settings	$\Delta G$	< 3	dB
Source Current	$I_{EE}$	< 10	mA
Input Third Order Intercept	ITOI	36	dBm
Input 1-dB Compression Point	$P_{1dB}$	23	dBm

1.  $T_B = \text{MMIC Base Temperature}$

M/A-COM Inc. and its affiliates reserve the right to make changes to the product(s) or information contained herein without notice. M/A-COM makes no warranty, representation or guarantee regarding the suitability of its products for any particular purpose, nor does M/A-COM assume any liability whatsoever arising out of the use or application of any product(s) or information.

• **North America** Tel: 800.366.2266 / Fax: 978.366.2266  
 • **Europe** Tel: 44.1908.574.200 / Fax: 44.1908.574.300  
 • **Asia/Pacific** Tel: 81.44.844.8296 / Fax: 81.44.844.8298

Visit [www.macom.com](http://www.macom.com) for additional data sheets and product information.

## Maximum Operating Conditions <sup>1</sup>

Parameter	Symbol	Absolute Maximum	Units
Input Power	$P_{IN}$	30	dBm
Source Supply Voltage	$V_{EE}$	-4.8	V
Source Current (No RF)	$I_{EQ}$	20	mA
Junction Temperature	$T_j$	180	°C
Storage Temperature	$T_{STG}$	-55 to +150	°C

1. Operation outside of these ranges may reduce product reliability. Operation at other than the typical values may result in performance outside the guaranteed limits.

## Recommended Operating Conditions

Characteristic	Symbol	Min	Typ	Max	Unit
Source Voltage	$V_{EE}$	-5.2	-5	-4.8	V
Control Voltage	$V_{control\ pads}$				
Logic High		3	5	5	V
Logic Low		0	0	0.4	V

## Operating Instructions

This device is static and light sensitive. The digital circuitry operation can be impaired under high intensity light, e.g. microscope light. Please handle with care.

To operate the device, follow these steps.

1. Power Up: Apply  $V_{EE} = -5\text{ V}$ .
2. Apply Logic Voltages to control Circuits as listed in Recommended Operating Conditions
3. Power Down: Set  $V_{EE} = 0$

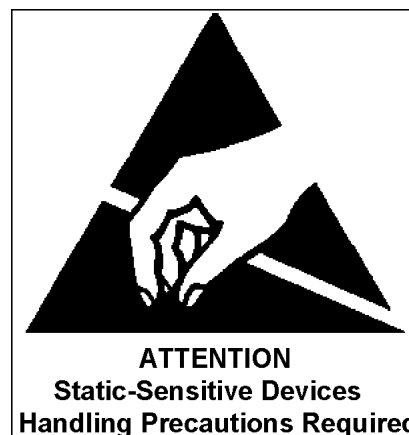

2.3-4.1 GHz Phase Shifter

MAPCGM0003-DIE

RO-P-DS-3045 A

Preliminary Information

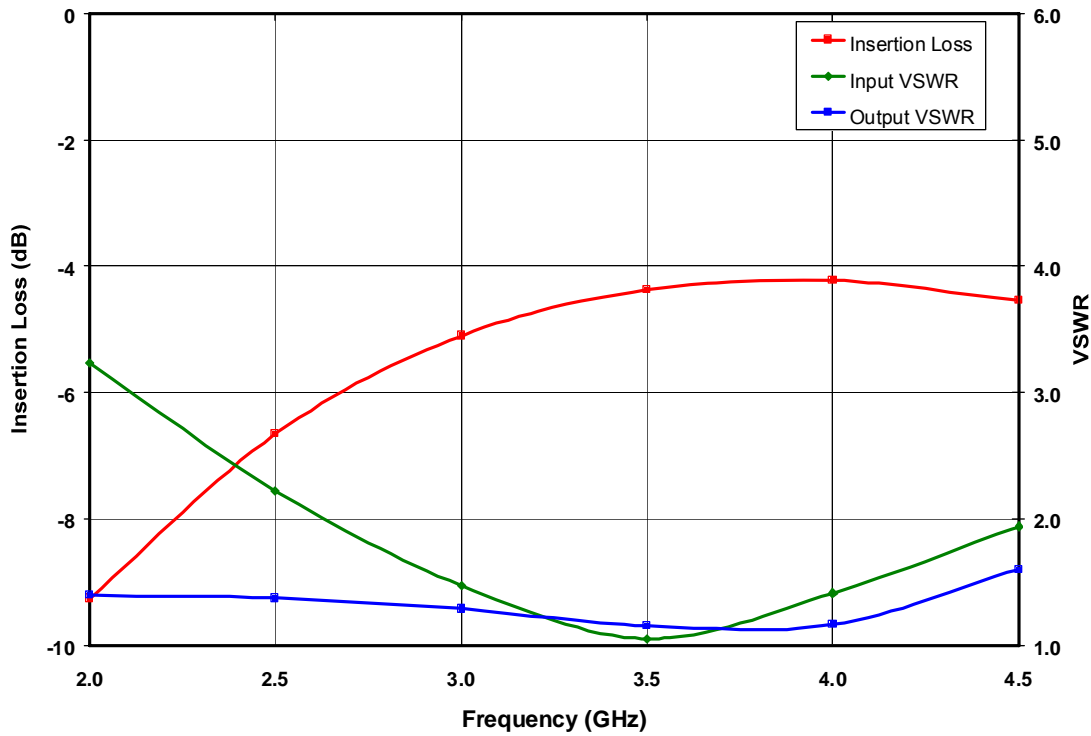

Figure 1. Reference State Insertion Loss, Input and Output VSWR vs. Frequency

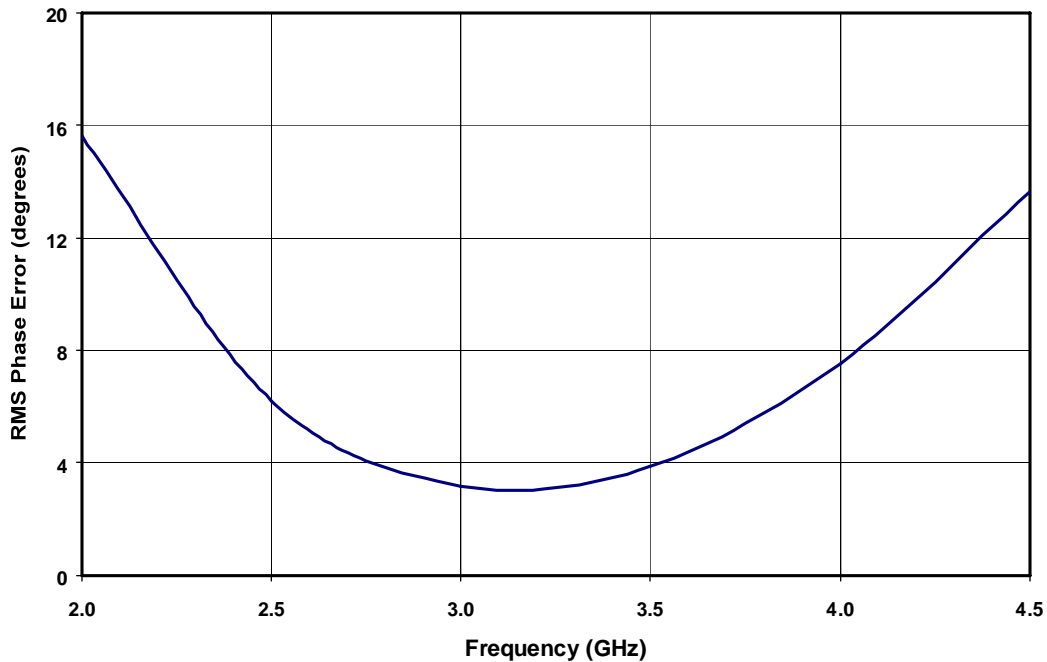

Figure 2. Uncorrected RMS Phase Error Over All Phase States vs. Frequency

2.3-4.1 GHz Phase Shifter

MAPCGM0003-DIE  
RO-P-DS-3045 A  
Preliminary Information

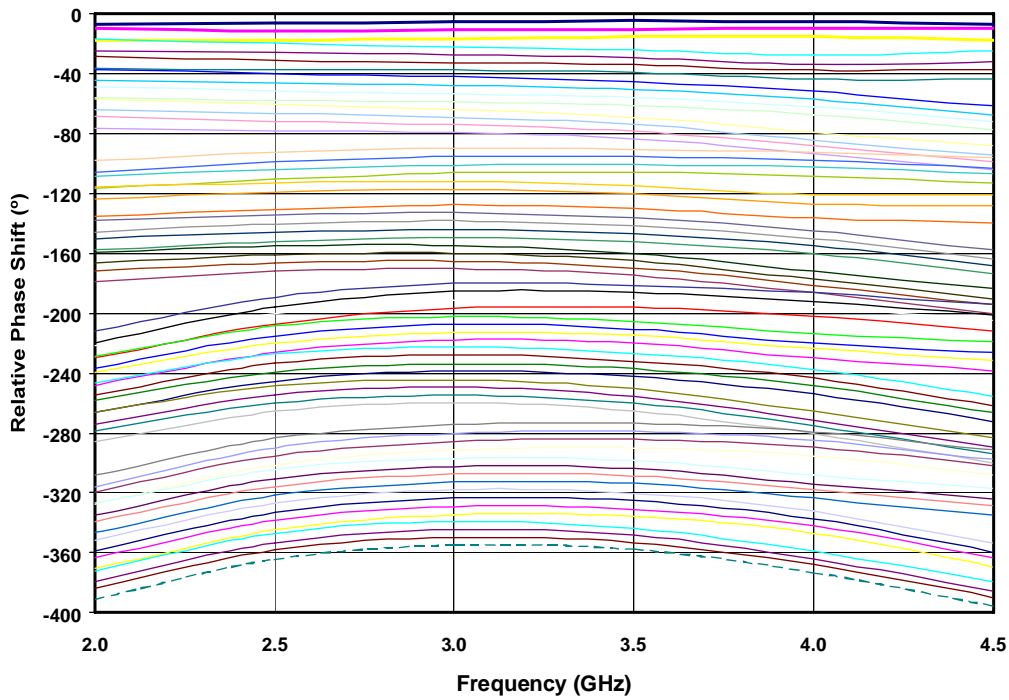

Figure 3. Relative Phase Shift vs. Frequency For All Phase States

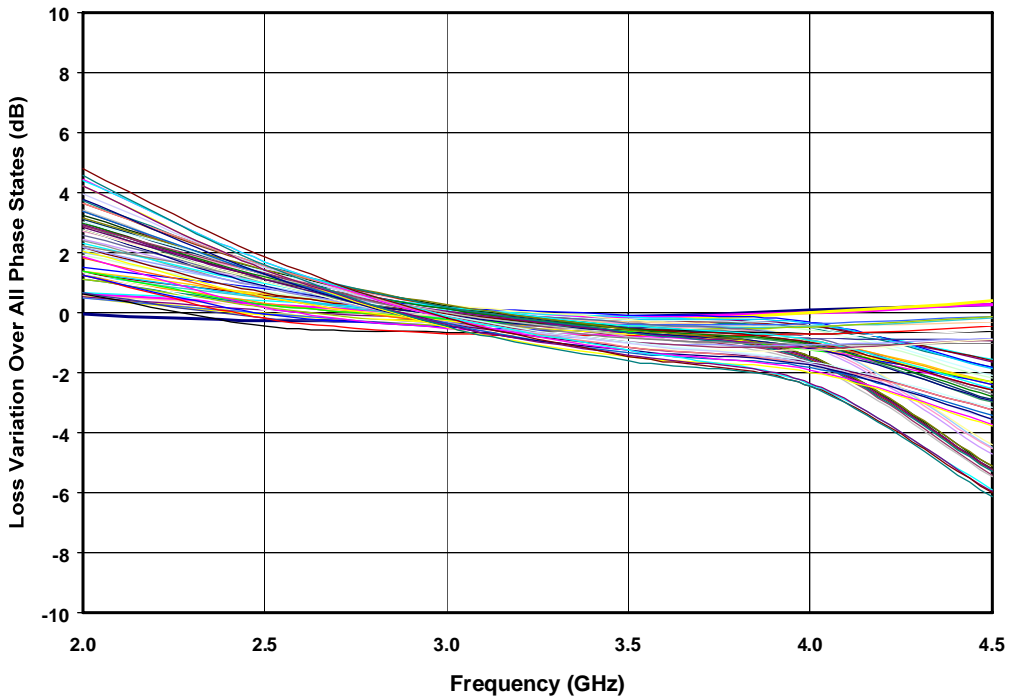

Figure 4. Loss Variation Over All Phase States vs. Frequency

2.3-4.1 GHz Phase Shifter

MAPCGM0003-DIE  
RO-P-DS-3045 A  
Preliminary Information

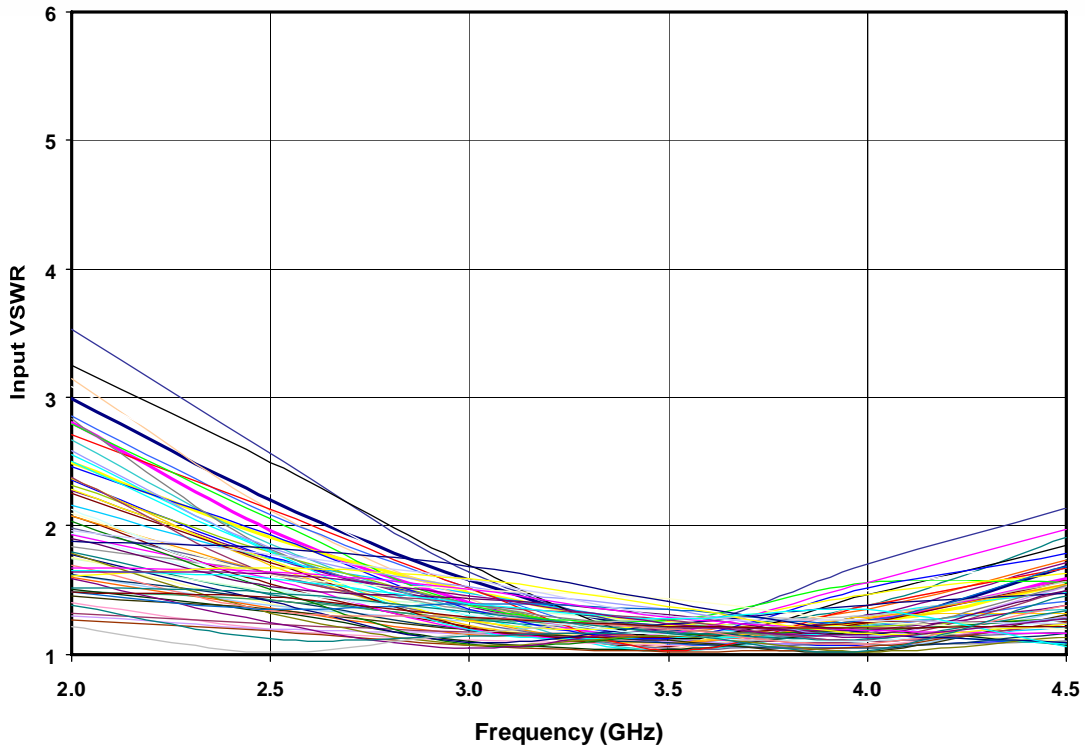

Figure 5. Input VSWR Over All Phase States vs. Frequency

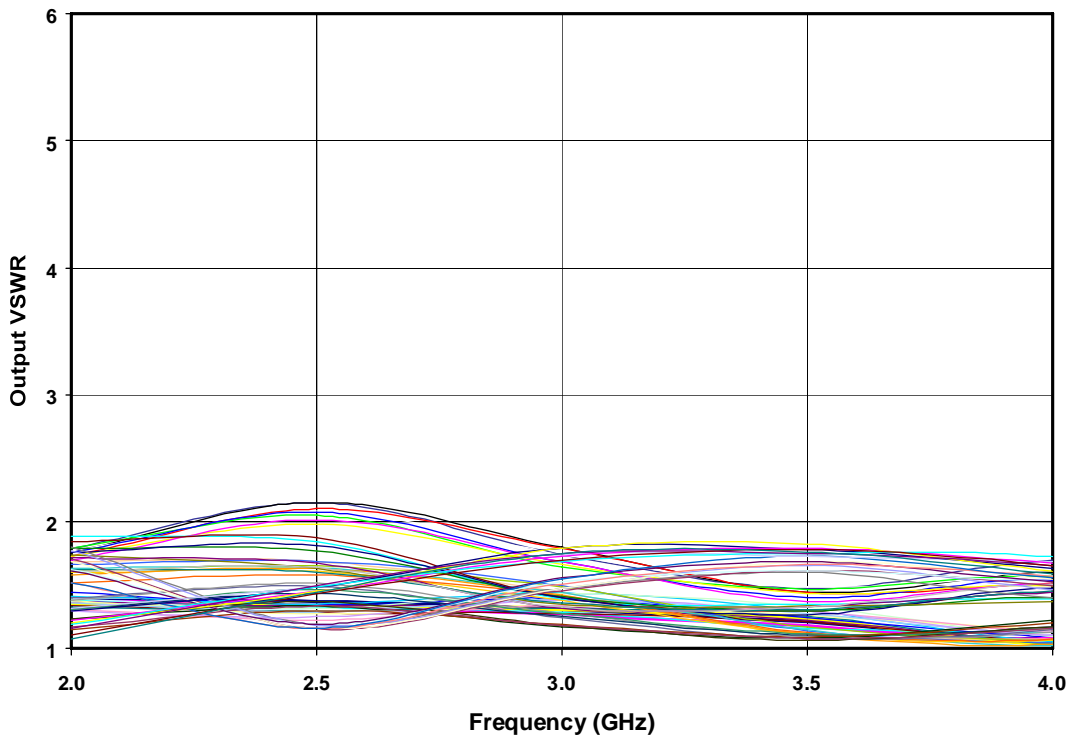

Figure 6. Output VSWR Over All Phase States vs. Frequency

**Mechanical Information**

Chip Size: 3.814 x 1.355 x 0.075 mm (150 x 55 x 3 mils)

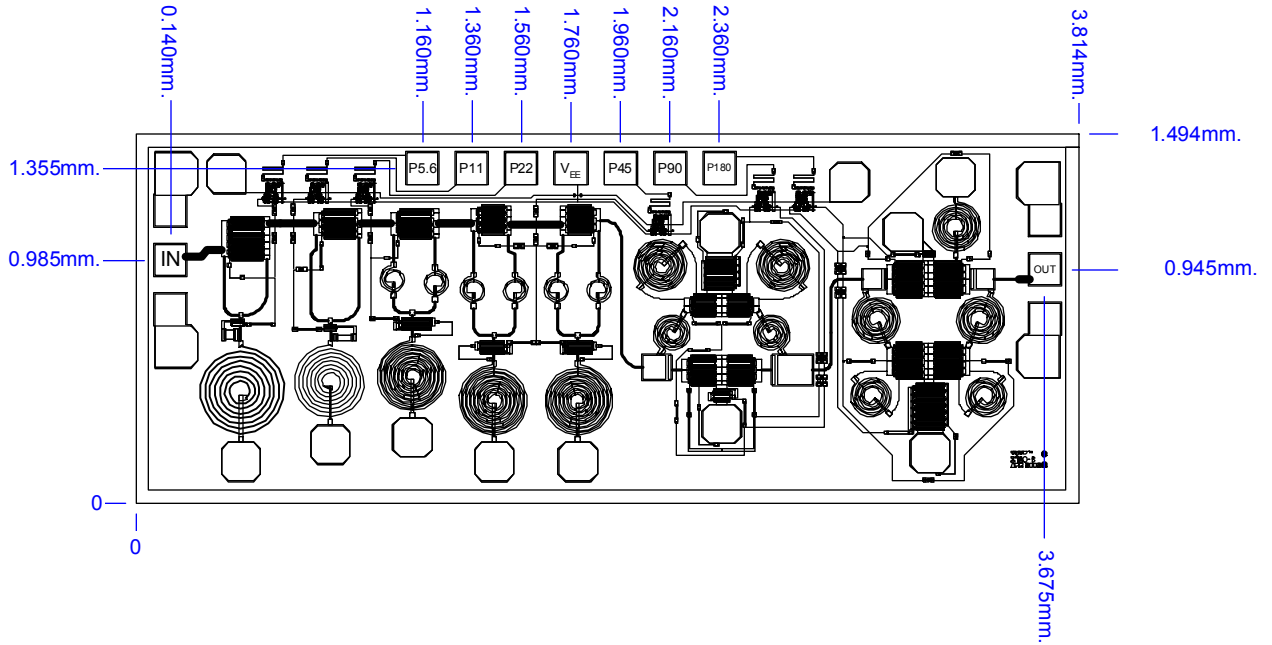
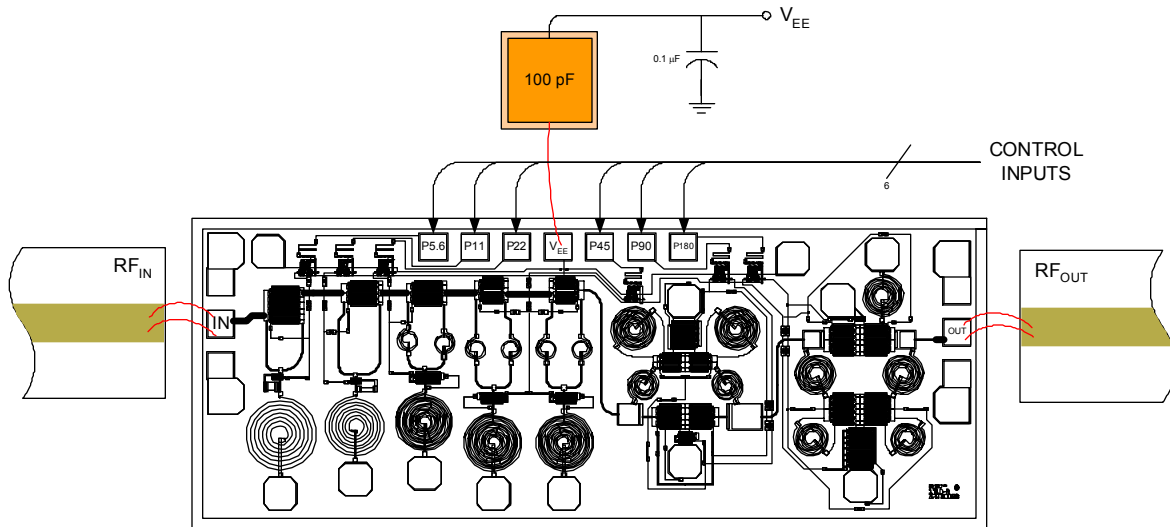

Figure 5. Die Layout

**Bond Pad Dimensions**

Pad	Size (µm)	Size (mils)
RF In and Out	100 x 200	4 x 8
DC Supply Voltage VEE	125 x 125	5 x 5
DC Control Voltage VC	125 x 125	5 x 5



**Figure 6. Recommended bonding diagram** for pedestal mount. Support circuitry typical of MMIC characterization.

**Assembly Instructions:**

**Die attach:** Use AuSn (80/20) 1-2 mil. preform solder. Limit time @ 300 °C to less than 5 minutes.

**Wirebonding:** Bond @ 160 °C using standard ball or thermal compression wedge bond techniques. For DC pad connections, use either ball or wedge bonds. For best RF performance, use wedge bonds of shortest length, although ball bonds are also acceptable.

**Biasing Note:** Must apply negative bias to  $V_{EE}$  before applying positive bias to Control Pads.