

M/A-COM S-Band Phase Shifter

2.3-4.1 GHz

MAPCGM0003

Preliminary Information

Features

- ◆ 2.3 to 4.1 GHz Operation
- ◆ 6 Bit Phase Shifter
- ◆ 360° Coverage, LSB = 5.6°
- ◆ TTL Control Inputs
- ◆ Self-Aligned MSAG® MESFET Process
- ◆ 6mm, 28 Lead, FQFP-N Package

Primary Applications

- ◆ Satellite Communication
- ◆ Phased Array Radar

Description

The MAPCGM0003 is a 6-bit Phase Shifter with Parallel TTL Input Control and is packaged in a micro lead package (MLP). This product is fully matched to 50 ohms on both the input and output. This part has 360° of phase coverage in 5.6° increments.

Each device is 100% RF tested on wafer to ensure performance compliance. The part is fabricated using M/A-COM's repeatable, high performance and highly reliable GaAs Multifunction Self-Aligned Gate (MSAG®) MESFET Process.

2.3-4.1 GHz GaAs MMIC Phase Shifter

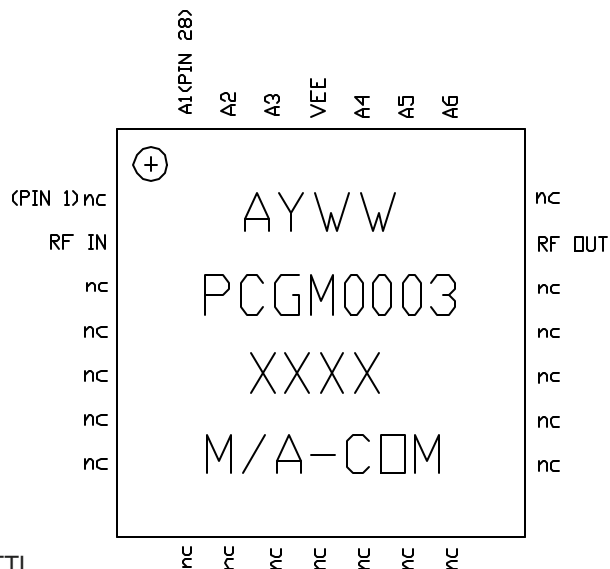

Pin Number	Designation
2	RF IN
20	RF OUT
22	A6 (180°)
23	A5 (90°)
24	A4 (45°)
25	V _{EE}
26	A3 (22.5°)
27	A2 (11.25°)
28	A1 (5.6°)
1,3-19,21	No connection

Maximum Operating Conditions ¹

Parameter	Symbol	Absolute Maximum	Units
Input Power	P _{IN}	30	dBm
Source Supply Voltage	V _{EE}	-4.8	V
Junction Temperature	T _J	180	°C
Storage Temperature	T _{STG}	-55 to +150	°C

1. Operation outside of these ranges may reduce product reliability. Operation at other than the typical values may result in performance outside the guaranteed limits.

Recommended Operating Conditions

Characteristic	Symbol	Min	Typ	Max	Unit
Digital Supply Voltage	VEE	-5.2	-5.0	-4.8	V
Control Voltage	A1 thru A6				
Logic High		3	5	5	V
Logic Low		0	0	0.4	V
Junction Temperature	T _J			150	°C

Electrical Characteristics: T_B = 25°C, Z₀ = 50W, V_{EE} = -5V

Parameter	Symbol	Typical	Units
Bandwidth	f	2.3-4.1	GHz
Insertion Loss	IL	6	dB
Input VSWR (At Reference)	VSWR	1.5:1	
Output VSWR (At Reference)	VSWR	1.2:1	
RMS Phase Error	RMS	6	°
RMS Phase Error — Calibrated	RMS	3	°
Phase Range	??	360	°
Gain Variation over all Phase Shifter settings	?G	< 3	dB
Digital Supply Current	I _{EE}	< 10	mA
Input Third Order Intercept	ITOI	36	dBm
Input 1-dB Compression Point	P _{1dB}	23	dBm

Operating Instructions

This device is static sensitive. Please handle with care. To operate the device, follow these steps.

1. Apply V_{EE} = -5 V.
2. Apply Logic Voltages to control circuit as listed in Recommended Operating Conditions Table.
3. Power Down. Set V_{EE} = 0.



Specifications subject to change without notice.

Email: macom_adbu_ics@tycoelectronics.com

- **North America:** Tel. (800) 366-2266
- **Asia/Pacific:** Tel.+81-44-844-8296, Fax +81-44-844-8298
- **Europe:** Tel. +44 (1908) 574 200, Fax+44 (1908) 574 300

tyco / Electronics

MACOM

Visit www.macom.com for additional data sheets and product information.

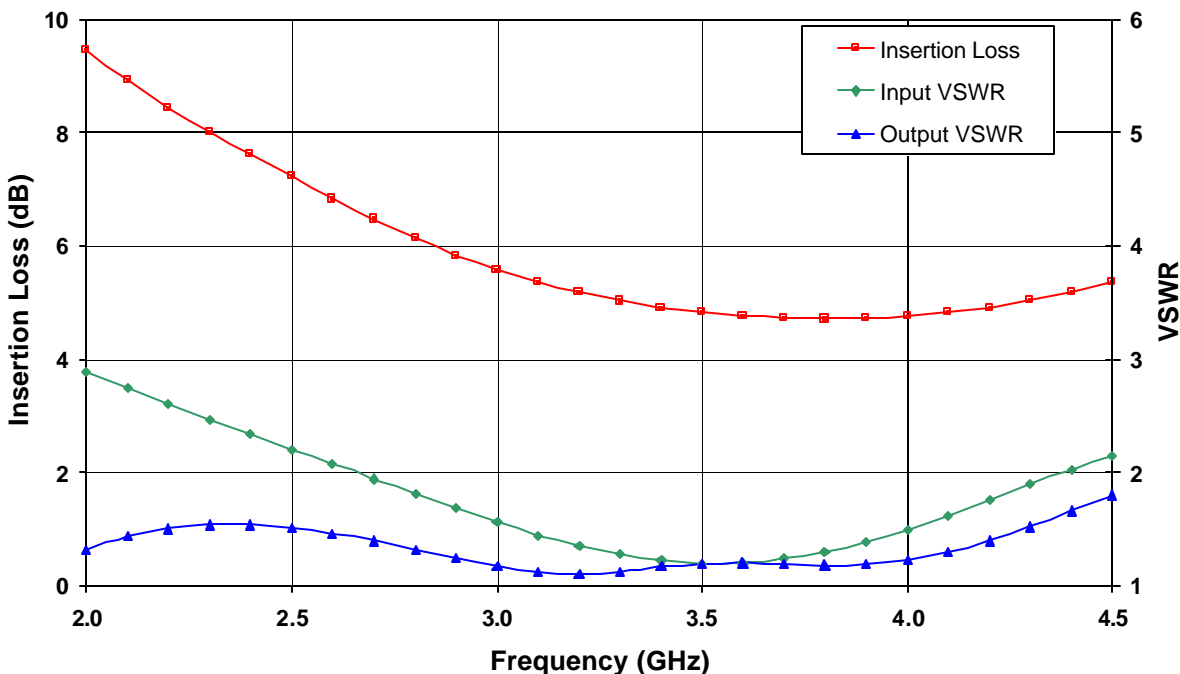

Figure 1. Reference State Insertion Loss, Input and Output VSWR vs. Frequency

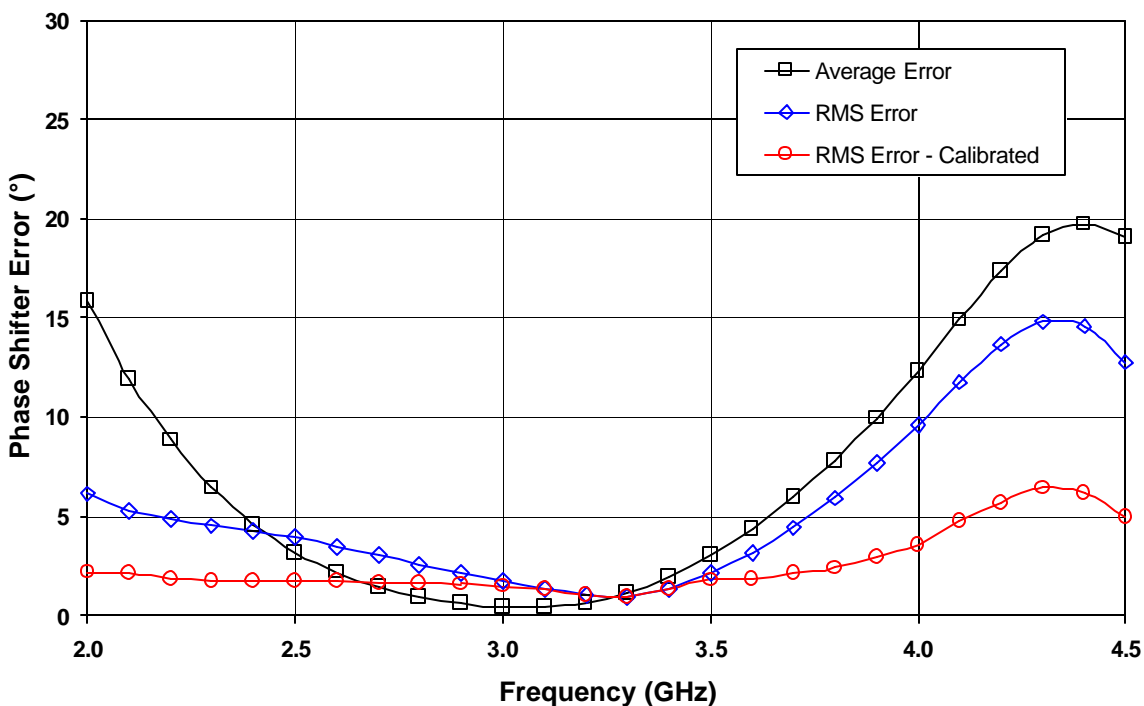

Figure 2. Phase Shifter Figures of Merit: Average Error vs. Reference State, RMS Error and Calibrated RMS Error Over All States

Specifications subject to change without notice.

Email: macom_adbu_ics@tycoelectronics.com

- North America: Tel. (800) 366-2266
- Asia/Pacific: Tel.+81-44-844-8296, Fax +81-44-844-8298
- Europe: Tel. +44 (1908) 574 200, Fax+44 (1908) 574 300



Visit www.macom.com for additional data sheets and product information.

S Band Phase Shifter **MAPCGM0003**

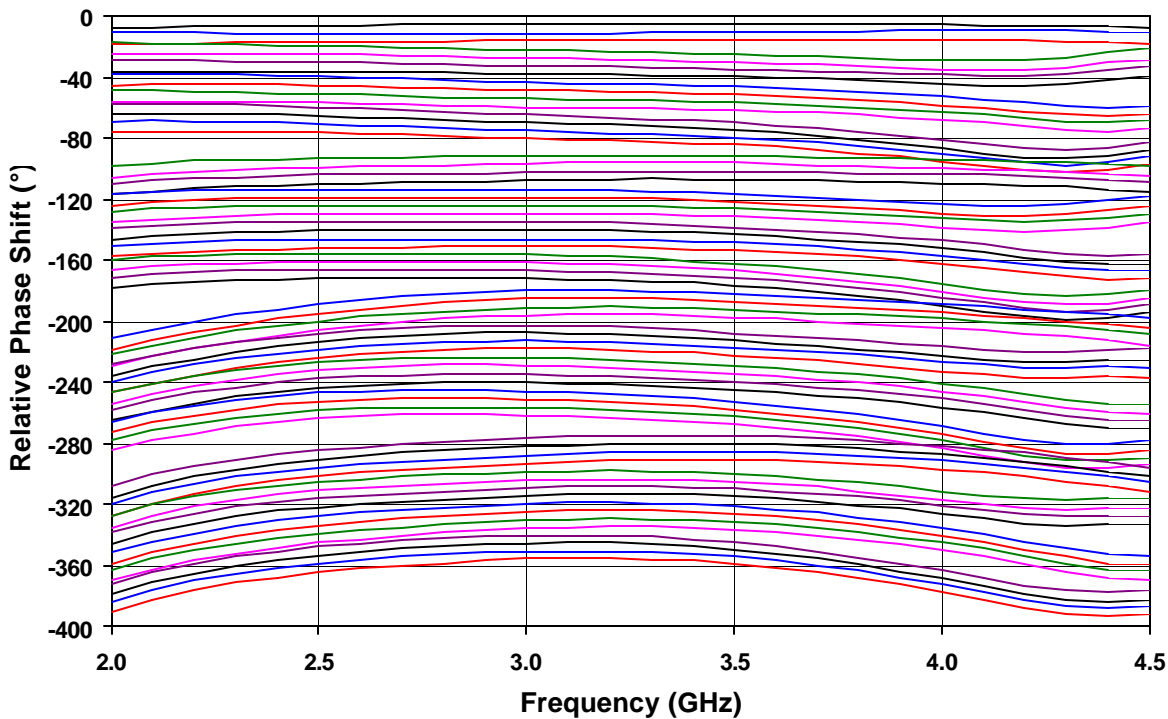

Figure 3. Relative Phase Shift vs. Phase Shifter State

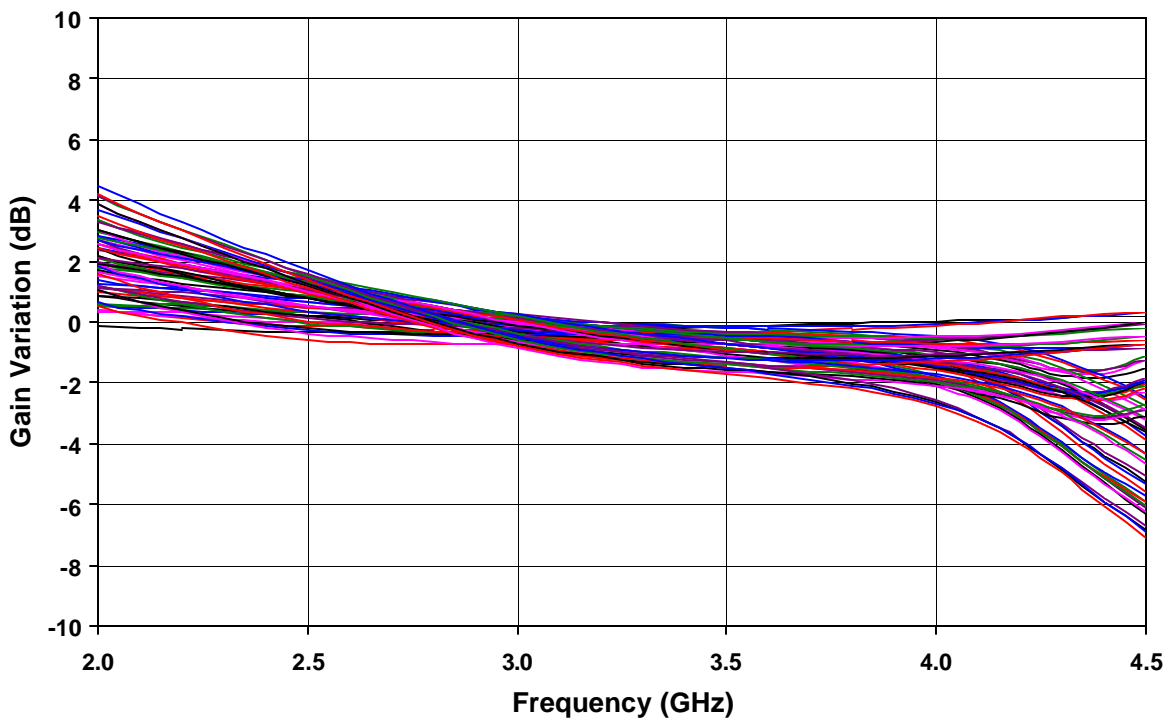

Figure 4. Relative Gain Change vs. Phase Shifter State

Specifications subject to change without notice.

Email: macom_adbu_ics@tycoelectronics.com

- North America: Tel. (800) 366-2266
- Asia/Pacific: Tel.+81-44-844-8296, Fax +81-44-844-8298
- Europe: Tel. +44 (1908) 574 200, Fax+44 (1908) 574 300



Visit www.macom.com for additional data sheets and product information.

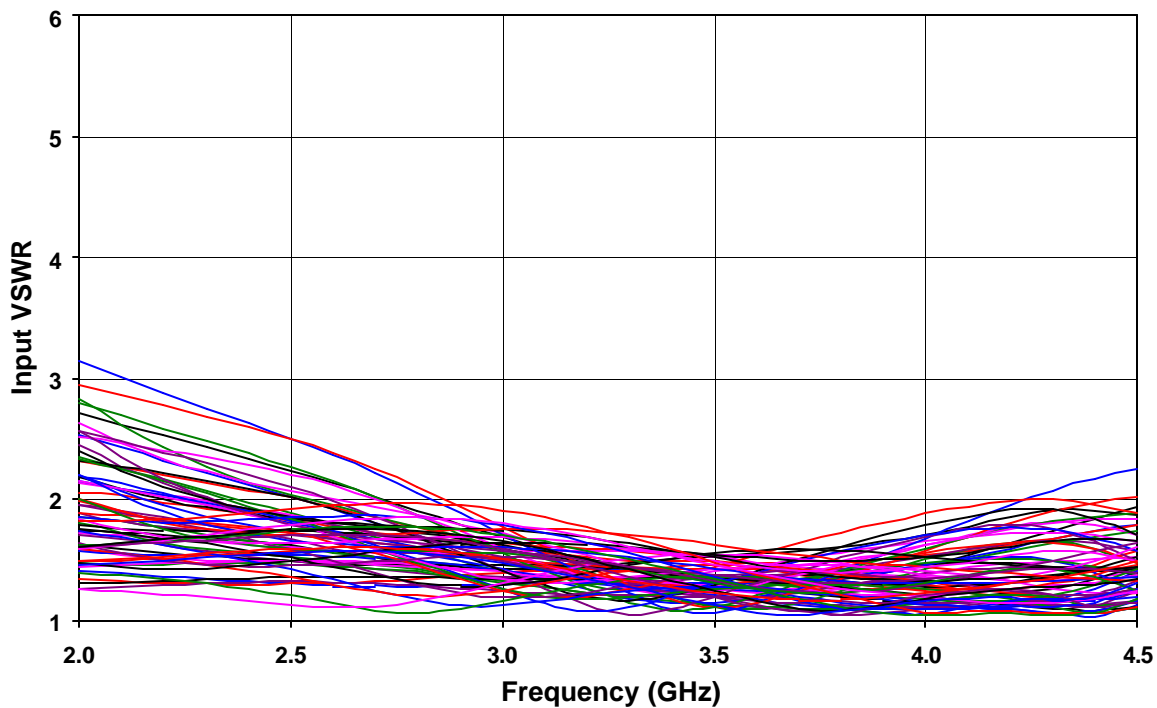

Figure 5. Input VSWR vs. Phase Shifter State

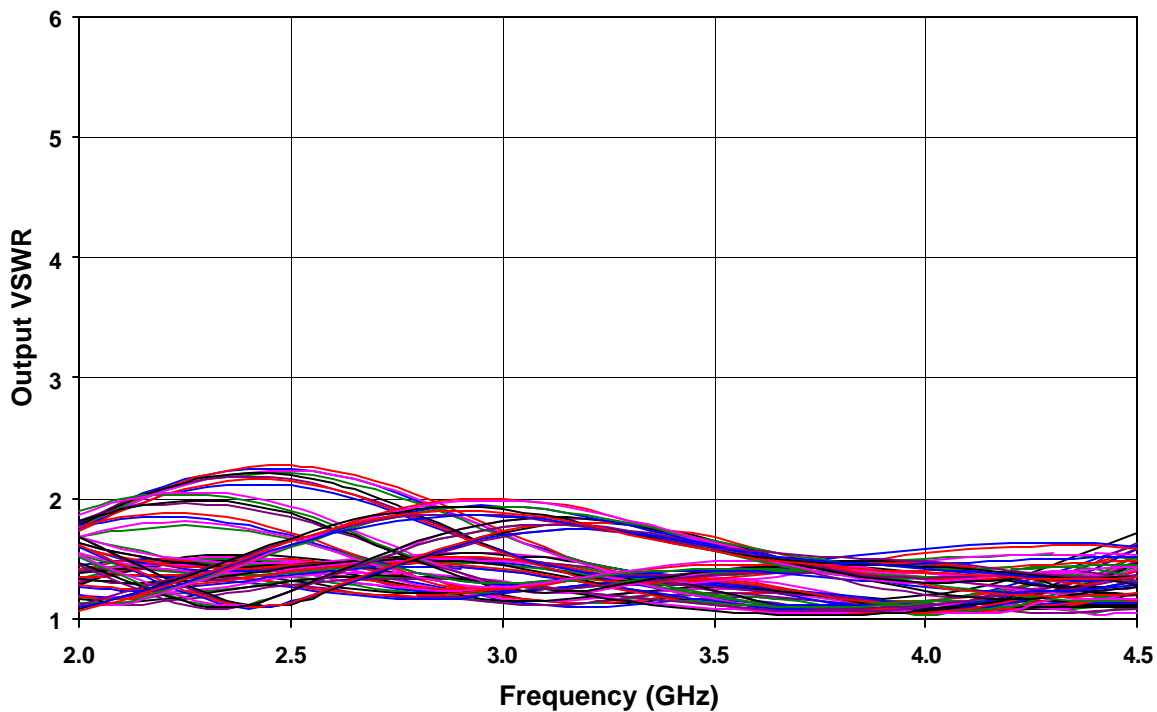

Figure 6. Output VSWR vs. Phase Shifter State

Specifications subject to change without notice.

Email: macom_adbu_ics@tycoelectronics.com

- North America: Tel. (800) 366-2266
- Asia/Pacific: Tel.+81-44-844-8296, Fax +81-44-844-8298
- Europe: Tel. +44 (1908) 574 200, Fax+44 (1908) 574 300

tyco / Electronics

MACOM

Visit www.macom.com for additional data sheets and product information.

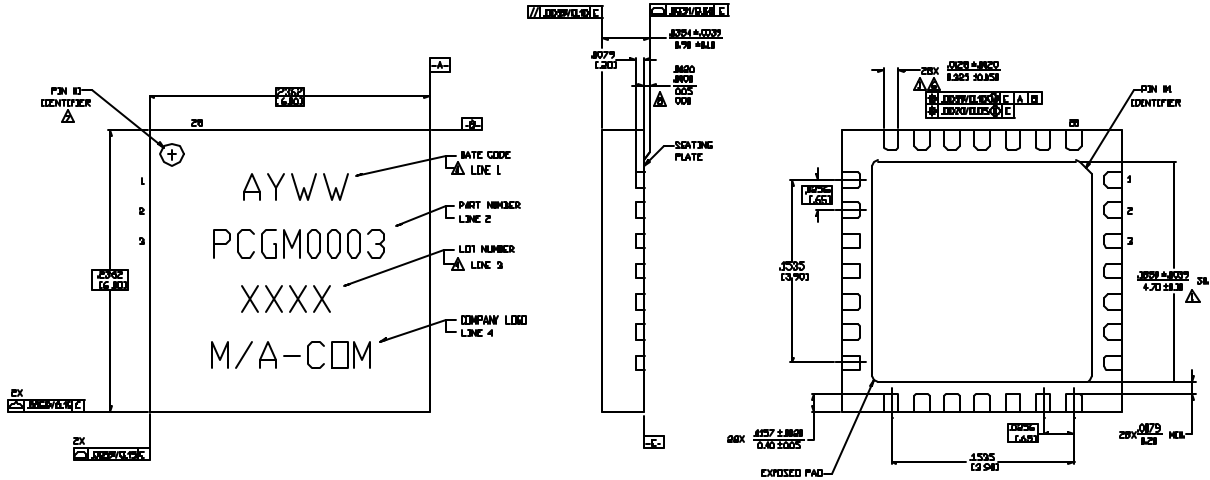

Figure 7. FQFP-N, 6mm, 28 Lead Package Drawing

Reference JEDEC M0-220 (see <http://www.jedec.org>), VAR. VJJC-3 (Issue E) for additional dimensional and tolerance information.

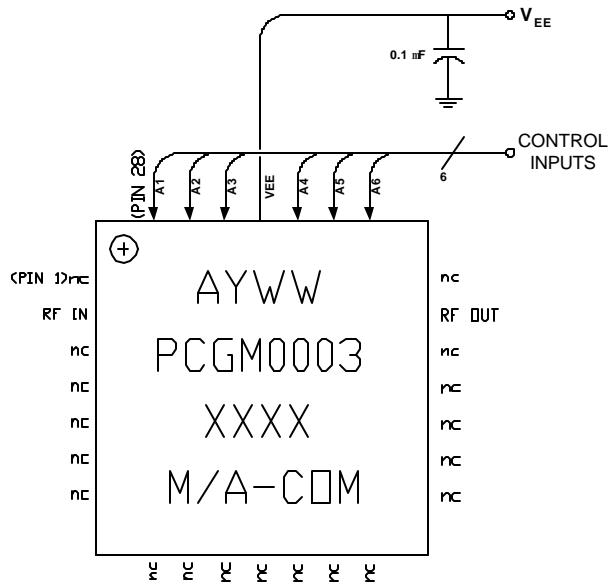

Figure 8. Recommended Bias Configuration

Refer to M/A-COM Application Note **Surface Mounting Instructions for FQFP-N Packages #S2083*** for assembly guidelines.

Application Notes can be found by going to the Site Search Page on M/A-COM's web page (<http://www.macom.com/search/search.jsp>) and searching for the required Application Note.

Specifications subject to change without notice.

Email: macom_adbu_ics@tycoelectronics.com

- North America: Tel. (800) 366-2266
- Asia/Pacific: Tel.+81-44-844-8296, Fax +81-44-844-8298
- Europe: Tel. +44 (1908) 574 200, Fax+44 (1908) 574 300



Visit www.macom.com for additional data sheets and product information.

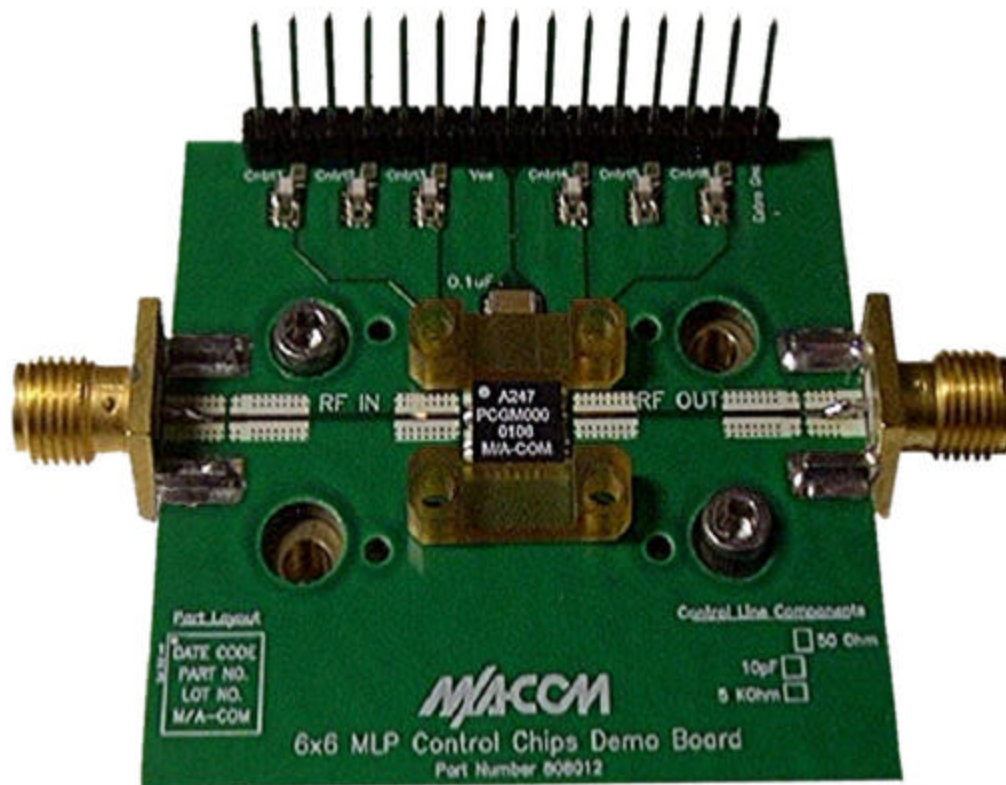

Figure 9. Demonstration Board (available upon request).

Specifications subject to change without notice.

Email: macom_adbu_ics@tycoelectronics.com

- North America: Tel. (800) 366-2266
- Asia/Pacific: Tel.+81-44-844-8296, Fax +81-44-844-8298
- Europe: Tel. +44 (1908) 574 200, Fax+44 (1908) 574 300

tyco / Electronics

MACOM

Visit www.macom.com for additional data sheets and product information.