

# M/A-COM 6-Bit Digital Phase Shifter

## 7.0-12.0 GHz

Preliminary Information

MAPCGM0005-DIE

### Features

- ◆ 6 Bit Digital Phase Shifter
- ◆ 7.0-12.0 GHz Operation
- ◆ 360° Coverage, LSB = 5.6°
- ◆ TTL Control Inputs
- ◆ Self-Aligned MSAG<sup>®</sup> MESFET Process

### Primary Applications

- ◆ Satellite Communication
- ◆ Military and Weather Radar

### Description

The MAPCGM0005-Die is a 6-bit Phase Shifter with Parallel TTL Input Control. This product is fully matched to 50 ohms on both the input and output. The part has 360° of phase coverage with LSB of 5.6°.

Each device is 100% RF tested on wafer to ensure performance compliance. The part is fabricated using M/A-COM's repeatable, high performance and highly reliable GaAs Multifunction Self-Aligned Gate (MSAG<sup>®</sup>) MESFET Process.

### 7.0-12.0 GHz GaAs MMIC Phase Shifter

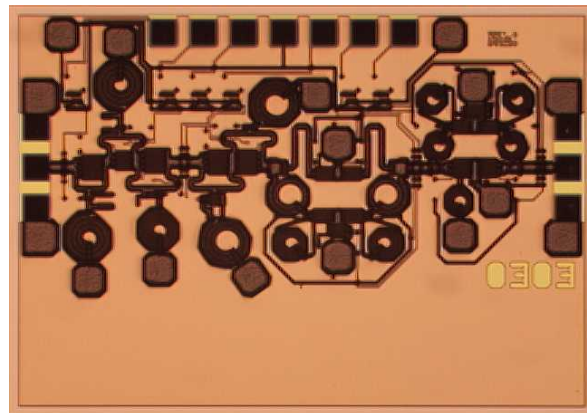

**Electrical Characteristics:**  $T_B = 40^\circ\text{C}^1$ ,  $Z_0 = 50\Omega$ ,  $V_{EE} = -5V$

Parameter	Symbol	Typical	Units
Bandwidth	f	7.0-12.0	GHz
Insertion Loss	IL	10	dB
Input VSWR, All States	VSWR	2.5:1	
Output VSWR, All States	VSWR	1.8:1	
RMS Phase Error	$\phi_{RMS}$	6	°
RMS Phase Error, Calibrated	$\phi_{RMS}$	3	°
Peak to Peak Gain Variation, All States	$\Delta G_n$	3	dB
Digital Driver Current	$I_{EE}$	< 10	mA
Input Third Order Intercept	ITOI	35	dBm
Input 1-dB Compression Point	P1dB	23	dBm

1.  $T_B$  = MMIC Base Temperature

## Maximum Operating Conditions <sup>1</sup>

Parameter	Symbol	Absolute Maximum	Units
Input Power	$P_{IN}$	30	dBm
Digital Driver Voltage	$V_{EE}$	-6.0	V
Junction Temperature	$T_J$	180	°C
Storage Temperature	$T_{STG}$	-55 to +150	°C

1. Operation outside of these ranges may reduce product reliability. Operation at other than the typical values may result in performance outside the guaranteed limits.

## Recommended Operating Conditions

Characteristic	Symbol	Min	Typ	Max	Unit
Digital Driver Voltage	$V_{EE}$	-5.2	-5	-4.8	V
Control Voltage	$V_{control\ pads}$				
Logic High		3	5	5	V
Logic Low		0	0	0.4	V

## Operating Instructions

This device is static and light sensitive. The digital circuitry operation can be impaired under high intensity light, e.g. microscope light. Please handle with care.

To operate the device, follow these steps.

1. Power Up: Apply  $V_{EE} = -5$  V.
2. Apply Logic Voltages to control Circuits as listed in Recommended Operating Conditions
3. Power Down: Set  $V_{EE} = 0$



Specifications subject to change without notice.

Customer Service: Tel. (888)-563-3949

Email: [macom\\_adbu\\_ics@tycoelectronics.com](mailto:macom_adbu_ics@tycoelectronics.com)

- **North America:** Tel. (800) 366-2266
- **Asia/Pacific:** Tel. +81-44-844-8296, Fax +81-44-844-8298
- **Europe:** Tel. +44 (1344) 869 595, Fax+44 (1344) 300 020

**tyco** / Electronics

**MACOM**

Visit [www.macom.com](http://www.macom.com) for additional data sheets and product information.

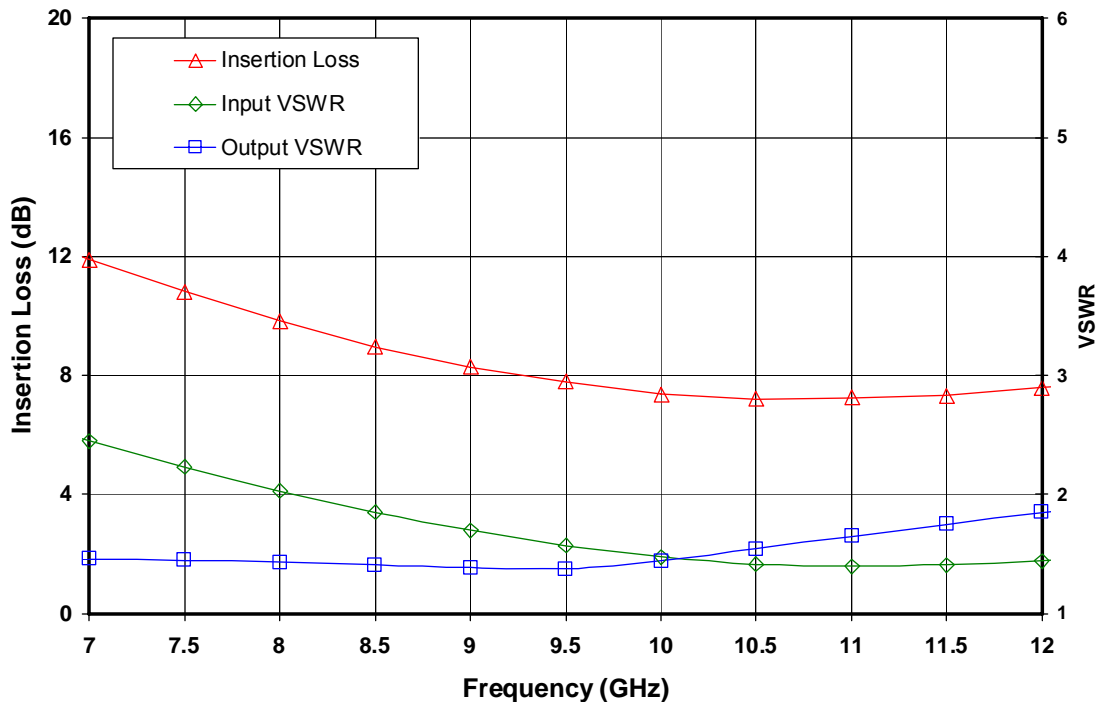

Figure 1. Reference State Insertion Loss, Input and Output VSWR vs. Frequency

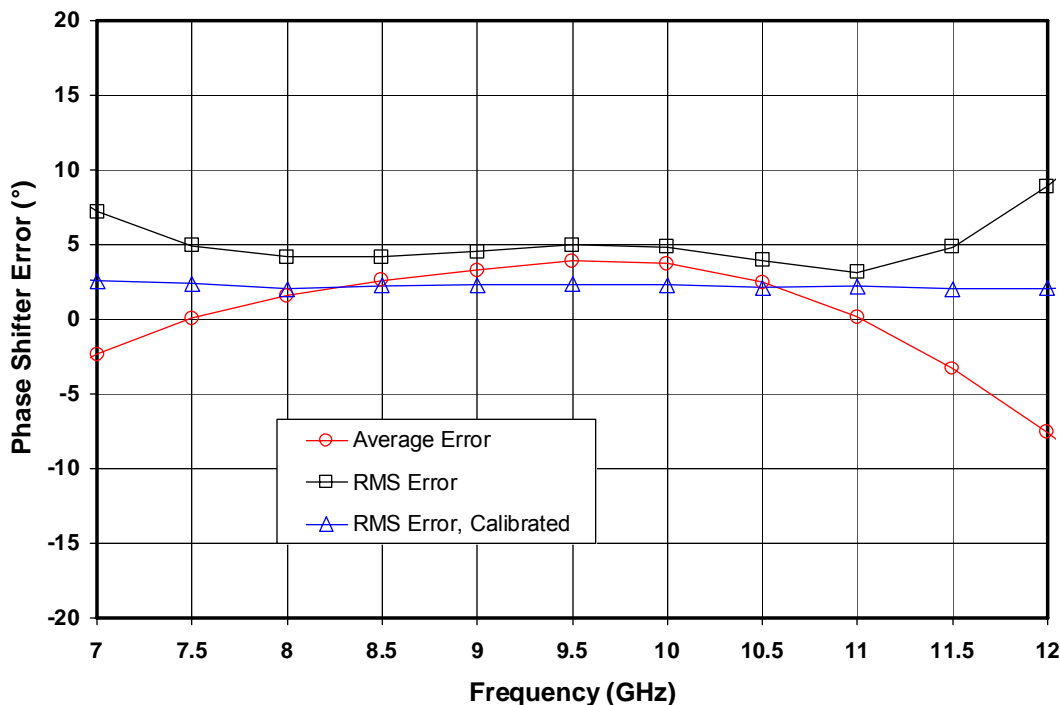

Figure 2. Phase Shifter Figures of Merit: Average Error vs Reference State, RMS Error and Calibrated RMS Error over All States

Specifications subject to change without notice.

Customer Service: Tel. (888)-563-3949

Email: [macom\\_adbu\\_ics@tycoelectronics.com](mailto:macom_adbu_ics@tycoelectronics.com)

- North America: Tel. (800) 366-2266
- Asia/Pacific: Tel. +81-44-844-8296, Fax +81-44-844-8298
- Europe: Tel. +44 (1344) 869 595, Fax+44 (1344) 300 020



Visit [www.macom.com](http://www.macom.com) for additional data sheets and product information.

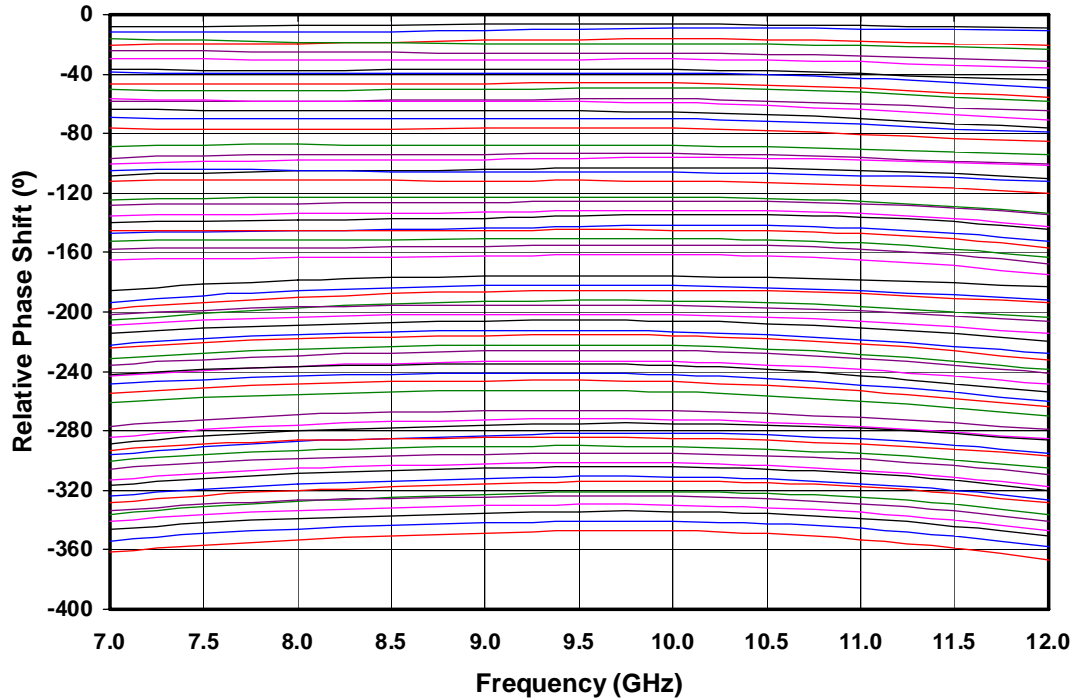

Figure 3. Relative Phase Shift vs Phase Shifter State

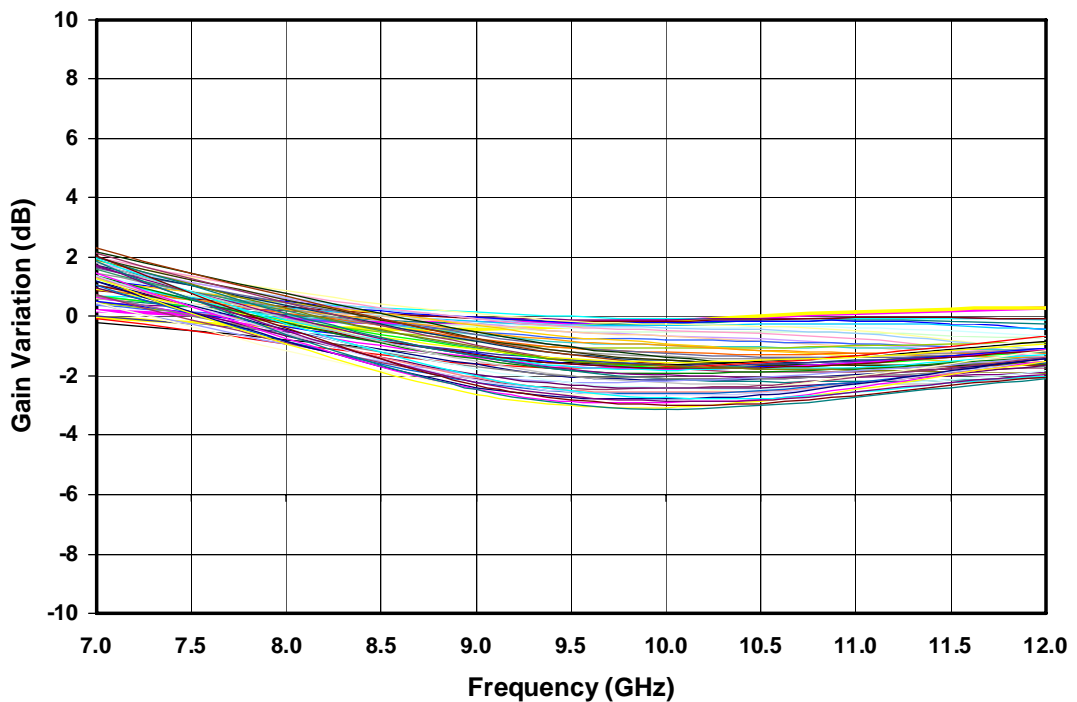

Figure 4. Relative Gain Change vs Phase Shifter State

Specifications subject to change without notice.

Customer Service: Tel. (888)-563-3949

Email: [macom\\_adbu\\_ics@tycoelectronics.com](mailto:macom_adbu_ics@tycoelectronics.com)

- North America: Tel. (800) 366-2266
- Asia/Pacific: Tel. +81-44-844-8296, Fax +81-44-844-8298
- Europe: Tel. +44 (1344) 869 595, Fax+44 (1344) 300 020

**tyco** / Electronics

**MACOM**

Visit [www.macom.com](http://www.macom.com) for additional data sheets and product information.

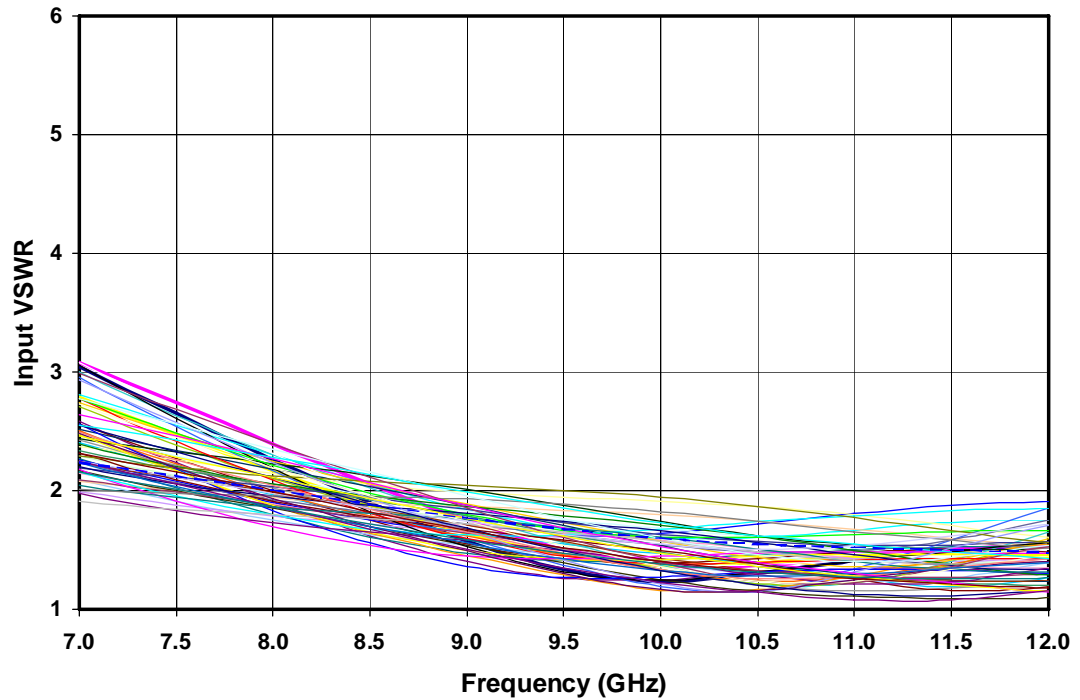

Figure 5. Input VSWR vs Phase Shifter State

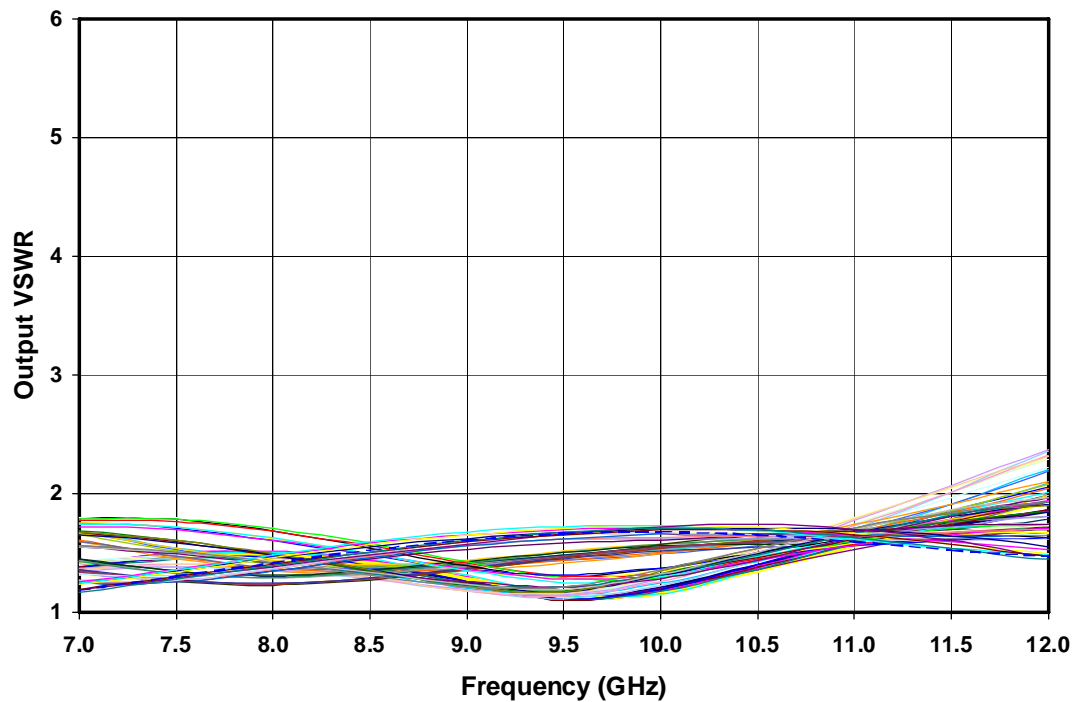

Figure 6. Output VSWR vs Phase Shifter State

Specifications subject to change without notice.

Customer Service: Tel. (888)-563-3949

Email: [macom\\_adbu\\_ics@tycoelectronics.com](mailto:macom_adbu_ics@tycoelectronics.com)

- North America: Tel. (800) 366-2266
- Asia/Pacific: Tel. +81-44-844-8296, Fax +81-44-844-8298
- Europe: Tel. +44 (1344) 869 595, Fax+44 (1344) 300 020

**tyco** / Electronics

**MACOM**

Visit [www.macom.com](http://www.macom.com) for additional data sheets and product information.

### Mechanical Information

Chip Size: 2.923 x 2.054 x 0.075 mm (115 x 81 x 3 mils)

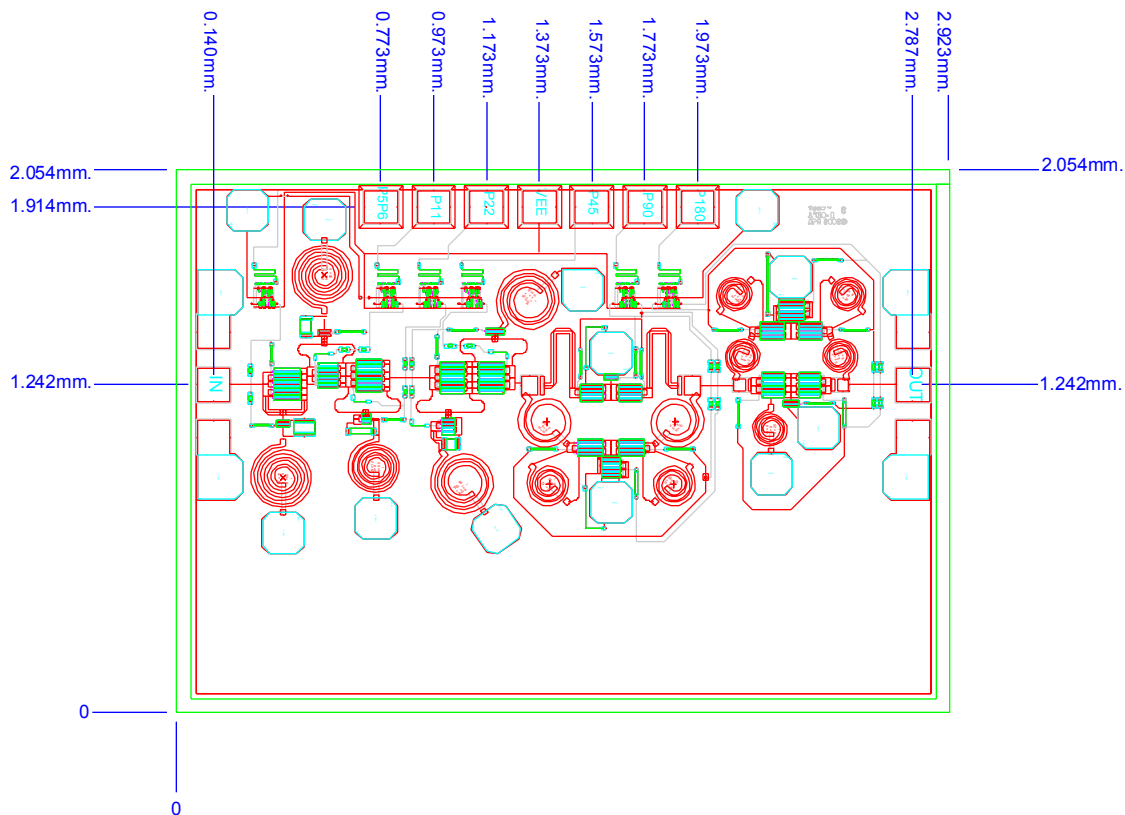

Figure 7. Die Layout

### Bond Pad Dimensions

Pad	Size (µm)	Size (mils)
RF (2)	100 x 200	4 x 8
Digital Driver Voltage VEE (1)	125 x 125	5 x 5
TTL Control (6)	125 x 125	5 x 5

Specifications subject to change without notice.

Customer Service: Tel. (888)-563-3949

Email: [macom\\_adbu\\_ics@tycoelectronics.com](mailto:macom_adbu_ics@tycoelectronics.com)

- North America: Tel. (800) 366-2266
- Asia/Pacific: Tel. +81-44-844-8296, Fax +81-44-844-8298
- Europe: Tel. +44 (1344) 869 595, Fax+44 (1344) 300 020



Visit [www.macom.com](http://www.macom.com) for additional data sheets and product information.

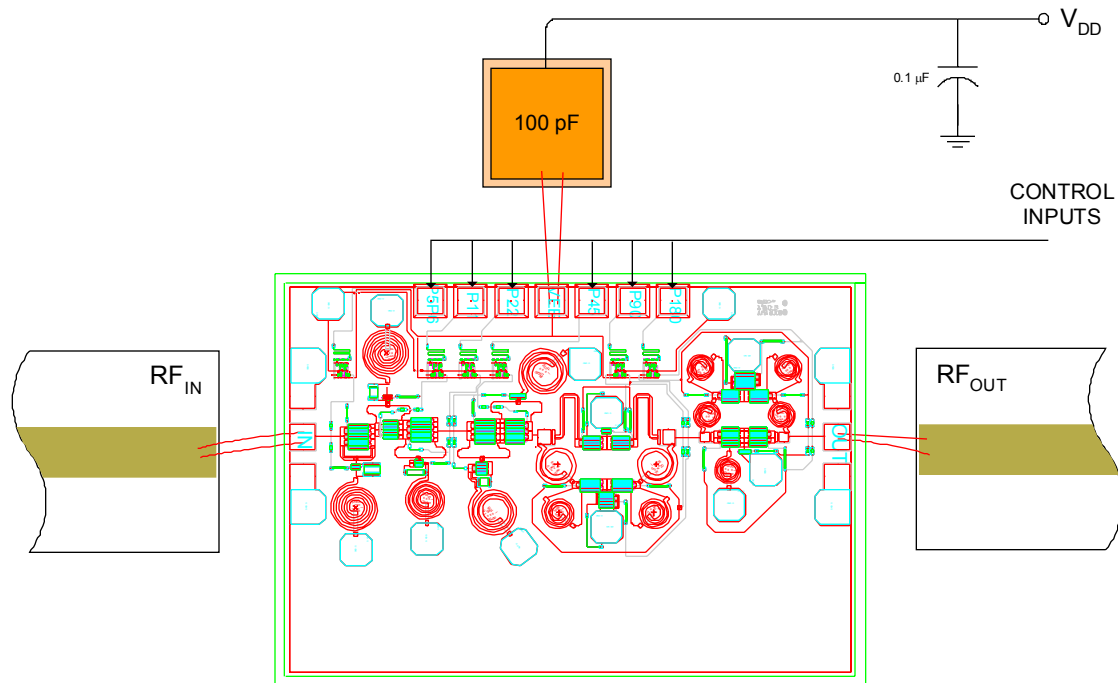

**Figure 8. Recommended bonding diagram for pedestal mount.**  
Support circuitry typical of MMIC characterization.

#### Assembly Instructions:

**Die attach:** Low thermal conductivity silver epoxies are acceptable for die attach of this MMIC. Follow the manufacturer's instructions. If solder is employed, use AuSn (80/20) 1-2 mil preform solder. Limit time @ 300 °C to less than 5 minutes.

**Wirebonding:** Bond @ 160 °C using standard ball or thermal compression wedge bond techniques. For DC and RF pad connections, use either ball or wedge bonds. For best performance, especially above 10 GHz, wedge bonds of shortest length employed on the RF interconnects is preferred over ball bonds.

**Biasing Note:** Must apply negative bias to  $V_{EE}$  before applying positive bias to Control Pads.

Specifications subject to change without notice.

Customer Service: Tel. (888)-563-3949

Email: [macom\\_adbu\\_ics@tycoelectronics.com](mailto:macom_adbu_ics@tycoelectronics.com)

- **North America:** Tel. (800) 366-2266
- **Asia/Pacific:** Tel. +81-44-844-8296, Fax +81-44-844-8298
- **Europe:** Tel. +44 (1344) 869 595, Fax+44 (1344) 300 020

**tyco** / Electronics

**MACOM**

Visit [www.macom.com](http://www.macom.com) for additional data sheets and product information.