

# MAPD-008108-C202C0



2-Way 0° Power Divider  
5 to 1000 MHz

M/A-COM Products  
Released, Rev. V2

## Features

- Surface Mount, hermetically sealed
- 2 Way, 0 Degree
- 260°C Reflow Compatible
- RoHS\* Compliant
- RoHS version of ESSMJ-2-12-75TR
- 75 Ohm
- Available on Tape and Reel

## Description

M/A-COM's MAPD-008108-C202C0 is a 2 Way 0° Power Divider in a low cost, surface mount package. Ideally suited for high volume CATV/Broadband applications.

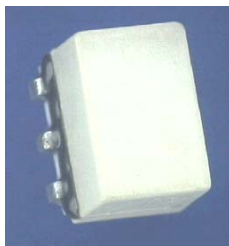

## Schematic

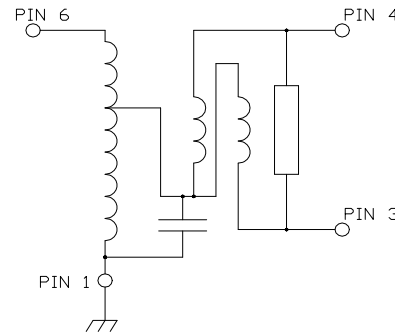

## Case style: SM-44

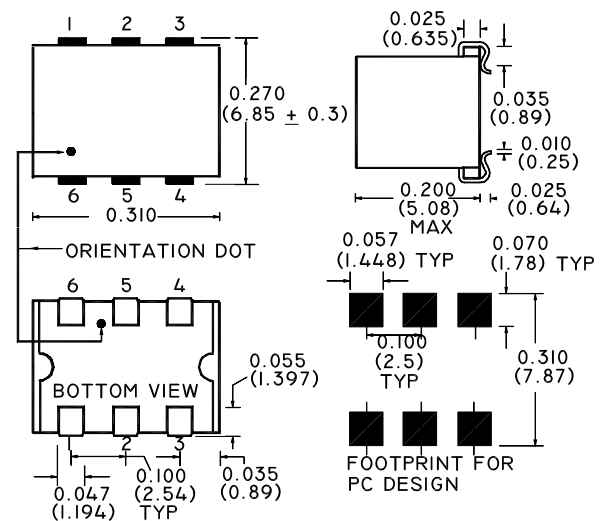

Dimensions in inches [mm] Tolerance: .xx ± .02, .xxx ± .010

## Pin configuration

Pin No.	Function
1	Ground
2	Not Connected
3	Output Port 2
4	Output Port 1
5	Not Connected
6	Input

Note: Reference Application Note **M513** for reel size information.

## Ordering information

Part Number	Description
MAPD-008108-C202C0	900 per reel
MAPD-008108-C202TB	Customer Test Board

\* Restrictions on Hazardous Substances, European Union Directive 2002/95/EC.

1

**ADVANCED:** Data Sheets contain information regarding a product M/A-COM Technology Solutions is considering for development. Performance is based on target specifications, simulated results, and/or prototype measurements. Commitment to develop is not guaranteed.  
**PRELIMINARY:** Data Sheets contain information regarding a product M/A-COM Technology Solutions has under development. Performance is based on engineering tests. Specifications are typical. Mechanical outline has been fixed. Engineering samples and/or test data may be available. Commitment to produce in volume is not guaranteed.

• **North America** Tel: 800.366.2266 • **Europe** Tel: +353.21.244.6400  
 • **India** Tel: +91.80.4155721 • **China** Tel: +86.21.2407.1588  
 Visit [www.macomtech.com](http://www.macomtech.com) for additional data sheets and product information.

M/A-COM Technology Solutions Inc. and its affiliates reserve the right to make changes to the product(s) or information contained herein without notice.

**Electrical Specifications:  $T_A = 25^\circ\text{C}$ ,  $Z_0 = 75\Omega$ ,  $P_{IN} = 0\text{dBm}$**

Parameter	Frequency	Units	Minimum	Typical	Maximum
Insertion Loss	5 - 500 MHz	dB	—	0.4	0.6
	500 - 1000 MHz	dB	—	0.5	1.2
Isolation	5 - 600 MHz	dB	20	35	—
	600 - 1000 MHz	dB	17.5	30	—
Amplitude Unbalance	5 - 600 MHz	dB	—	—	0.2
	600 - 1000 MHz	dB	—	—	0.5
Phase Unbalance	5 - 100 MHz	°	—	—	1.5
	100 - 500 MHz	°	—	—	3.5
	500 - 1000 MHz	°	—	—	4.0
Output Return Loss	5 - 40 MHz	dB	12	20	—
	40 - 1000 MHz	dB	20	25	—
Input Return Loss	5 - 40 MHz	dB	13.5	20	—
	40 - 500 MHz	dB	20	24	—
	500 - 860 MHz	dB	17	21	—
	860-1000 MHz	dB	14	19	—
Insertion Loss Flatness	5 - 1000 MHz	dB	—	—	0.9

**Absolute maximum ratings <sup>1,2</sup>**

Parameter	Absolute Maximum
RF Power	1 Watt
Internal Load Dissipation	0.125 Watt
Pin Temp (10 sec.)	260°C
Storage Temperature	-55°C to +100°C
Operating Temperature	-40°C to +85°C

1. Exceeding any one or combination of these limits may cause permanent damage to this device.
2. M/A-COM does not recommend sustained operation near these survivability limits.

**Typical Performance Curves:  $T_A = 25^\circ\text{C}$ ,  $Z_0 = 75\Omega$ ,  $P_{IN} = 0\text{dBm}$**

**Insertion Loss**

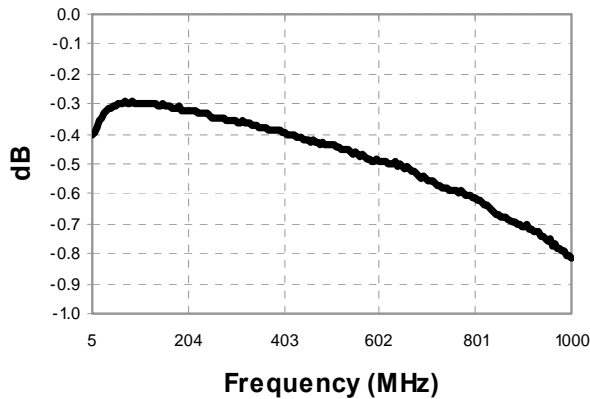

**Isolation**

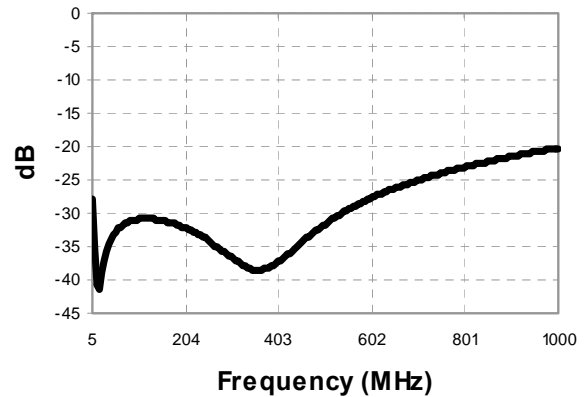

**Amplitude Balance**

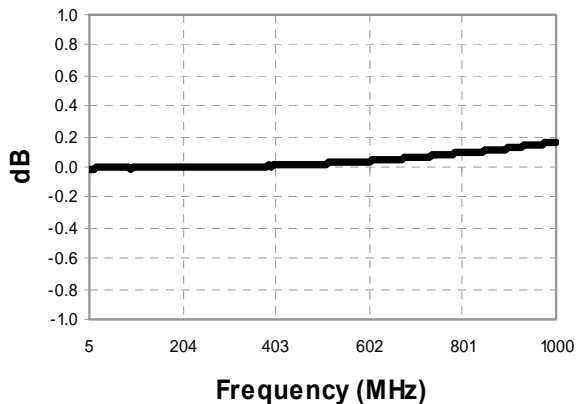

**Phase Balance**

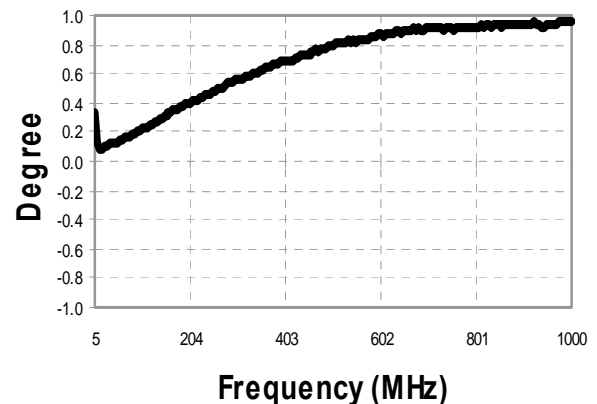

**Return Loss: Input**

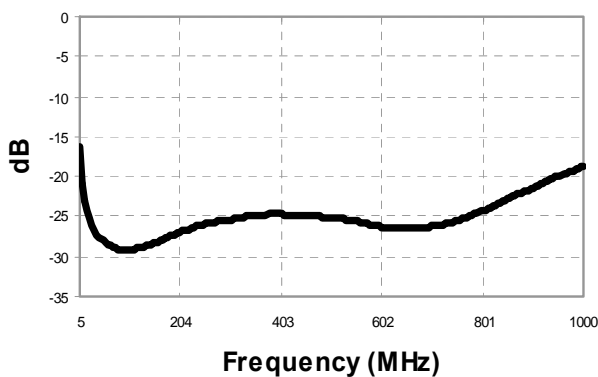

**Return Loss: Output**

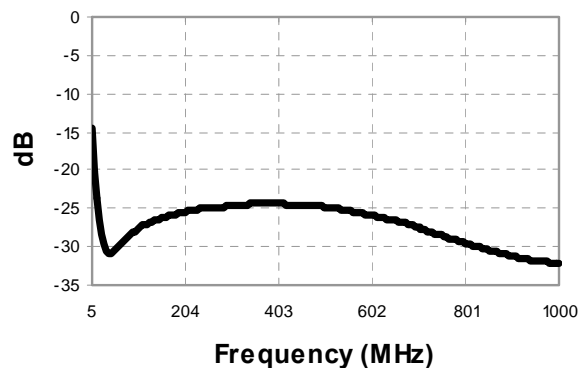

**ADVANCED:** Data Sheets contain information regarding a product M/A-COM Technology Solutions is considering for development. Performance is based on target specifications, simulated results, and/or prototype measurements. Commitment to develop is not guaranteed.  
**PRELIMINARY:** Data Sheets contain information regarding a product M/A-COM Technology Solutions has under development. Performance is based on engineering tests. Specifications are typical. Mechanical outline has been fixed. Engineering samples and/or test data may be available. Commitment to produce in volume is not guaranteed.

• **North America** Tel: 800.366.2266 • **Europe** Tel: +353.21.244.6400  
 • **India** Tel: +91.80.4155721 • **China** Tel: +86.21.2407.1588  
 Visit [www.macomtech.com](http://www.macomtech.com) for additional data sheets and product information.

M/A-COM Technology Solutions Inc. and its affiliates reserve the right to make changes to the product(s) or information contained herein without notice.