

## Features

- Small Size, Low Profile
- Superior Repeatability (Lot-to-Lot Variation)
- Typical Isolation 25 dB
- Typical Insertion Loss 0.8 dB
- Low Cost
- Lead-Free SOIC-16 Package
- 100% Matte Tin Plating over Copper
- Halogen-Free “Green” Mold Compound
- 260°C Reflow Compatible
- RoHS\* Compliant Version of DS56-0005

## Description

M/A-COM’s MAPDCC0019 is an IC-based monolithic power divider in a low cost SOIC-16 plastic package. The 6-way power divider is ideally suited for applications where PCB real estate is at a premium and part count reduction and cost are critical. Typical applications include base station switching networks and other cellular equipment, including subscriber units. Available in Tape and Reel.

The MAPDCC0019 is fabricated using a passive-integrated circuit process. The process features full-chip passivation for increased performance and reliability.

## Functional Block Diagram<sup>1</sup>

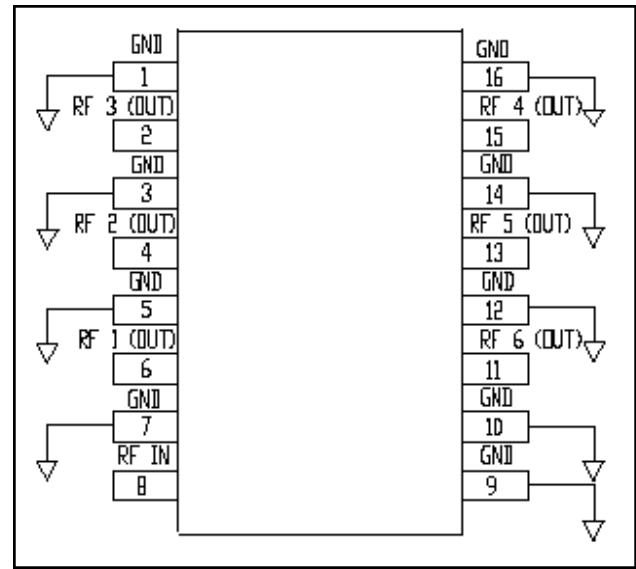

1. All unused pins must be RF and DC grounded.

## Ordering Information

Part Number	Package
MAPDCC0019	Bulk Packaging
MAPDCC0019-TR	1000 piece reel
MAPDCC0019-TB	Sample Test Board

Note: Reference Application Note M513 for reel size information.

## Pin Configuration

Pin No.	Function	Pin No.	Function
1	GND	9	GND
2	RF 3 (OUT)	10	GND
3	GND	11	RF 6 (OUT)
4	RF 2 (OUT)	12	GND
5	GND	13	RF 5 (OUT)
6	RF 1 (OUT)	14	GND
7	GND	15	RF 4 (OUT)
8	RF IN	16	GND

\* Restrictions on Hazardous Substances, European Union Directive 2002/95/EC.

## Electrical Specifications: $T_A = 25^\circ\text{C}$ , $Z_0 = 50\Omega$

Parameter	Units	Min	Typ	Max
Insertion Loss above 7.8 dB	dB	—	0.8	1.2
Isolation	dB	20	25	—
VSWR Input	—	—	1.4:1	1.8:1
Output	—	—	1.3:1	1.5:1
Amplitude Balance	dB	—	0.5	0.9
Phase Balance	Deg.	—	4	8

## Absolute Maximum Ratings <sup>2,3</sup>

Parameter	Absolute Maximum
Input Power <sup>4</sup>	1 W CW
Operating Temperature	-40°C to +85°C
Storage Temperature	-65°C to +150°C

- Exceeding any one or combination of these limits may cause permanent damage to this device.
- M/A-COM does not recommend sustained operation near these survivability limits.
- With internal load dissipation of 0.125 W maximum.

## Handling Procedures

Please observe the following precautions to avoid damage:

## Static Sensitivity

GMIC Circuits are sensitive to electrostatic discharge (ESD) and can be damaged by static electricity. Proper ESD control techniques should be used when handling these devices.

## Typical Performance Curves

Insertion Loss vs. Frequency

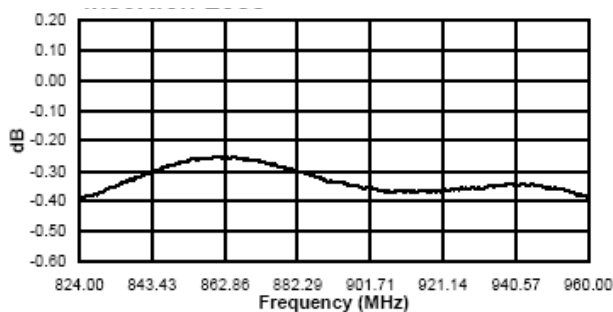

Amplitude Imbalance vs. Frequency

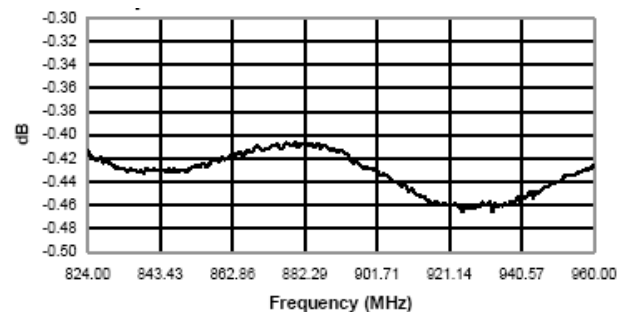

## Typical Performance Curves

*Isolation vs. Frequency*

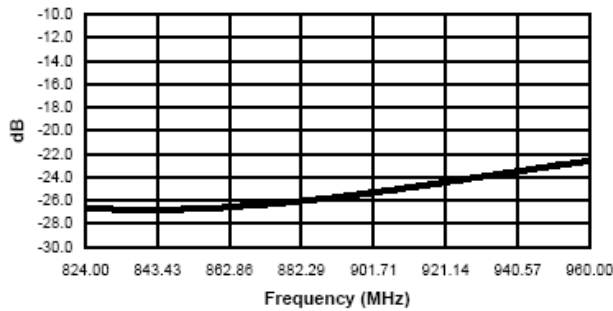

*Phase Imbalance vs. Frequency*

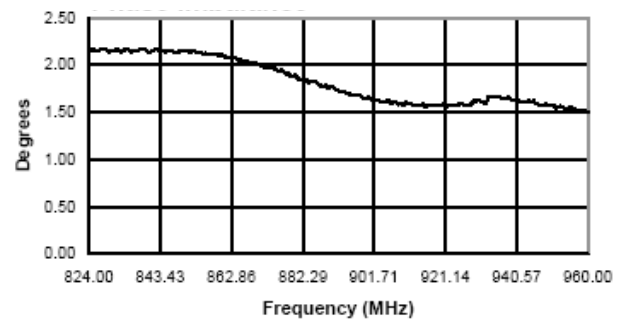

*Input VSWR vs. Frequency*

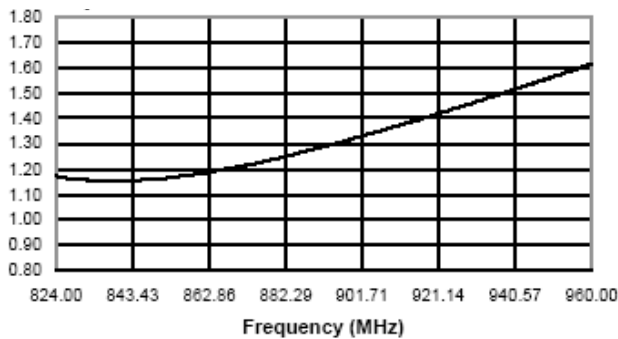

*Output VSWR vs. Frequency*

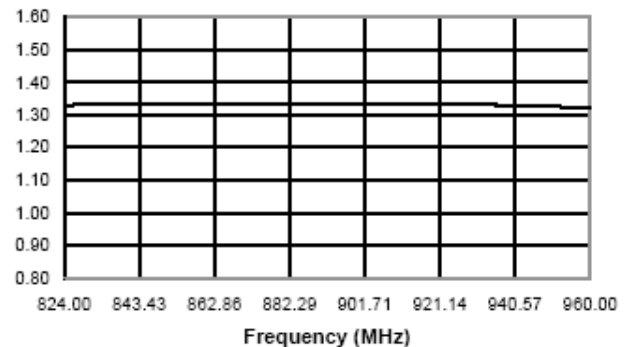

## Lead-Free, SOIC-16†

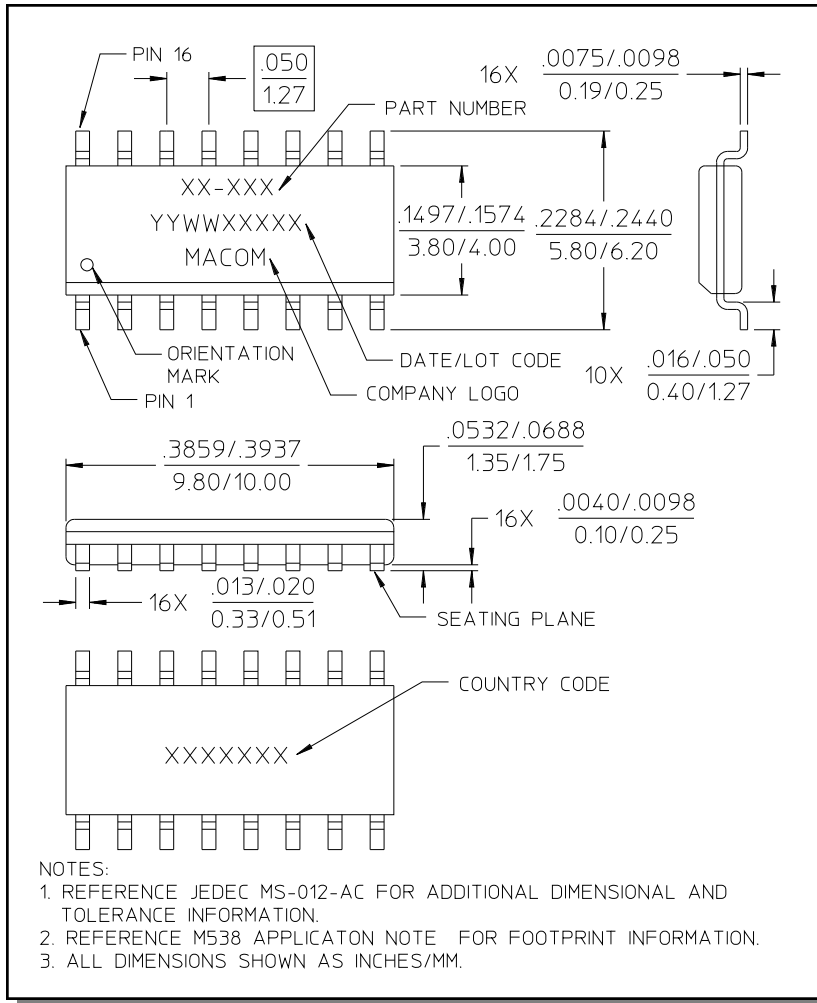

† Reference Application Note M538 for lead-free solder reflow recommendations.