

## 20 W HMIC Silicon PIN Diode Terminated SPDT Switch 8.0 - 10.5 GHz

Rev. V1

### Features

- Low Insertion Loss
- High Isolation
- Low Parasitic Capacitance and Inductance
- Fully Monolithic Die, Integrated Bias Network
- Glass Encapsulated Construction
- Greater than 20 W CW Power Handling @ +85°C
- Silicon Nitride Passivation
- Polymer Scratch Protection
- RoHS\* Compliant

### Description

The MASW-010647 is a monolithic, terminated Silicon PIN diode SPDT switch designed for X-Band high power, high performance applications. The switch handles greater than 20 W of CW power over the 8.0 - 10.5 GHz frequency band.

The device is fabricated using MACOM's patented HMIC process, which allows for the integration of silicon pedestals that embed series and shunt diodes in low loss, low dispersion glass. The switch offers low insertion loss of 0.8 dB as well as high isolation performance of 37 dB. The device integrates a bias network to allow for simplified bias application and switch control.

The topside is fully encapsulated with silicon nitride passivation and an additional polymer layer for scratch and impact protection. These protective coatings prevent damage to the semiconductor junctions and metal air bridges during handling and assembly.

### Functional Diagram

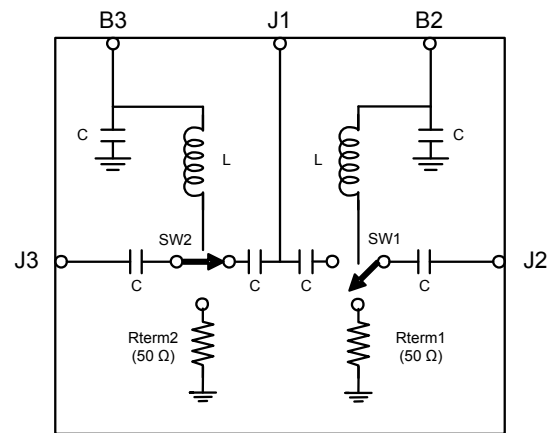

### Pin Configuration<sup>2</sup>

Pin	Function
J1	RF <sub>COMMON</sub>
J2	RF <sub>OUT</sub>
J3	RF <sub>OUT</sub>
B2	Bias of J2
B3	Bias of J3

2. The exposed metallization on the chip bottom must be connected to RF, DC and thermal ground.

### Ordering Information<sup>1</sup>

Part Number	Package
MASW-010647-13950G	Die in Gel Pack

1. Die quantity varies.

\* Restrictions on Hazardous Substances, European Union Directive 2011/65/EU.

## 20 W HMIC Silicon PIN Diode Terminated SPDT Switch 8.0 - 10.5 GHz

Rev. V1

**Electrical Specifications:  $T_A = +25^\circ\text{C}$ ,  $Z_0 = 50 \Omega$ ,  $P_{IN} = 0 \text{ dBm}$  (unless otherwise noted)**

Parameter	Test Conditions	Units	Min.	Typ.	Max.
Insertion Loss (-5 V <sup>3</sup> / 0 mA Bias)	8.0 GHz	dB	—	0.70	—
	8.5 GHz			0.70	0.9
	9.5 GHz			0.75	1.0
	10.5 GHz			0.85	1.1
Input to Output Isolation (+5 V / 55 mA Bias)	8.0 GHz	dB	—	33	—
	8.5 GHz		32	35	
	9.5 GHz		34	37	
	10.5 GHz		35	39	
Input Return Loss	8.0 GHz	dB	—	25	—
	8.5 GHz		19	28	
	9.5 GHz		17	24	
	10.5 GHz		13	18	
Return Loss (Termination) (+5 V / 55 mA Bias)	8.0 GHz	dB	—	14	—
	8.5 GHz		12	18	
	9.5 GHz		12	31	
	10.5 GHz		—	14	
Input IP3	10 GHz, +20 dBm, 10 & 100 MHz spacing	dBm	—	>60	—
Switching Speed <sup>4</sup>	10 GHz, +/- 4 V, PW 500 ns, 50% duty cycle	ns	—	130	—

3. R. Caverly and G. Hiller, "Establishing the Minimum Reverse Bias for a P-I-N Diode in a High Power Switch," IEEE Transactions on Microwave Theory and Techniques, Vol.38, No.12, December 1990

4. Typical switching speed measured from 10% to 90 % of detected RF signal driven by TTL compatible drivers. MACOM recommends the MADR-007097, Complementary Channel TTL PIN Diode Driver.

### Bias Control<sup>3</sup>

Optimal operation is achieved by simultaneous application of negative DC voltage to the low loss switch path and positive DC voltage to the isolating switch path.

In the low loss path, the diodes are reverse biased. In the isolating path, the diodes are forward biased.

Minimum Reverse Bias Required:

At X-Band, with a 1:1 match, 5 V of reverse bias is required. With a 4:1 match, 10 V of reverse bias is required.

However MACOM recommends 30 V of reverse bias to achieve optimal operating conditions.

### Driver Connections

DC Control Voltages (DC Currents)		Condition of RF Output	
B2	B3	J1-J2	J1-J3
-5 V <sup>3</sup> (0 mA)	+5 V (55 mA typ.)	Low Loss	Isolation
+5 V (55 mA typ.)	-5 V <sup>3</sup> (0 mA)	Isolation	Low Loss

## Absolute Maximum Ratings<sup>5,6</sup>

Parameter	Absolute Maximum
Applied Reverse Voltage	100 V
Bias Current	100 mA @ +85°C
RF CW Incident Power (Transmission)	20 W @ +85°C
RF CW Incident Power (Termination)	2 W @ +85°C
Junction Temperature	+175°C
Operating Temperature	-40°C to +85°C
Storage Temperature	-65°C to +150°C

- Exceeding any one or combination of these limits may cause permanent damage to this device.
- MACOM does not recommend sustained operation near these survivability limits.

## Handling Procedures

Please observe the following precautions to avoid damage:

## Static Sensitivity

Gallium Arsenide Integrated Circuits are sensitive to electrostatic discharge (ESD) and can be damaged by static electricity. Proper ESD control techniques should be used when handling these HBM class 1A devices.

## Functional Schematic

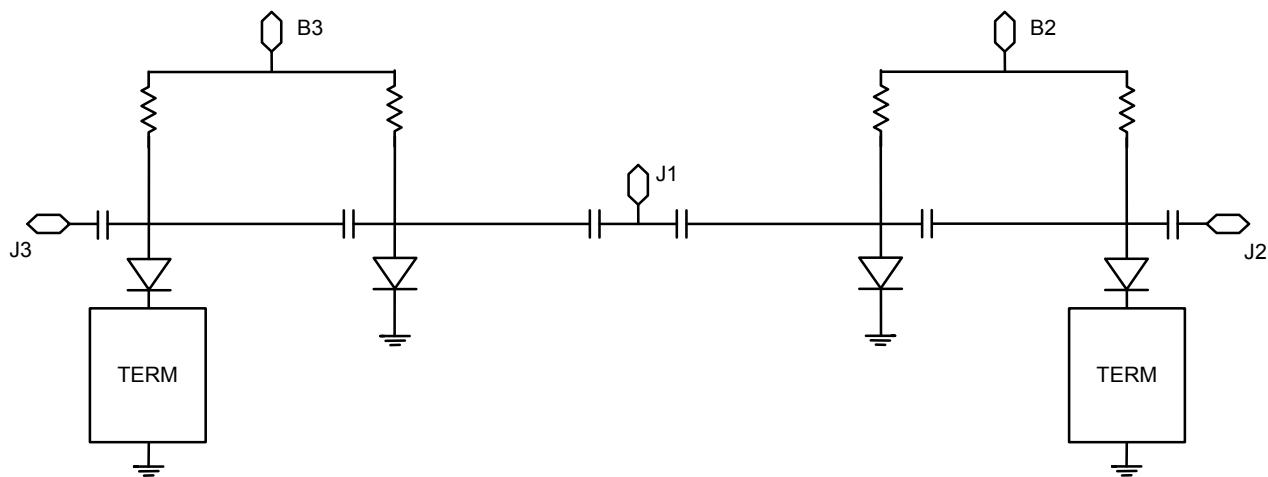

## 20 W HMIC Silicon PIN Diode Terminated SPDT Switch 8.0 - 10.5 GHz

Rev. V1

### Typical Performance: $T_A = +25^\circ\text{C}$

**Insertion Loss vs. Frequency, -5V**

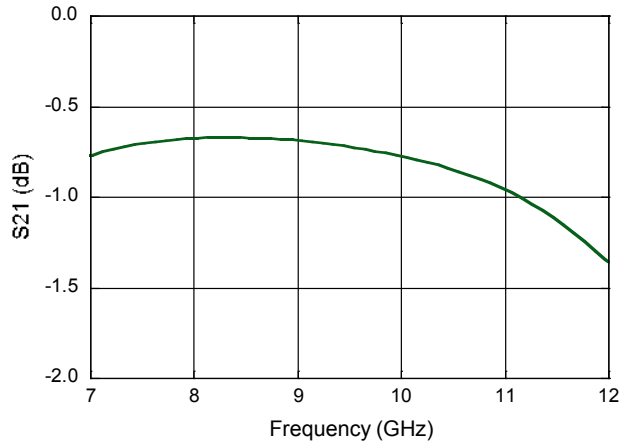

**Isolation vs. Frequency, +5V**

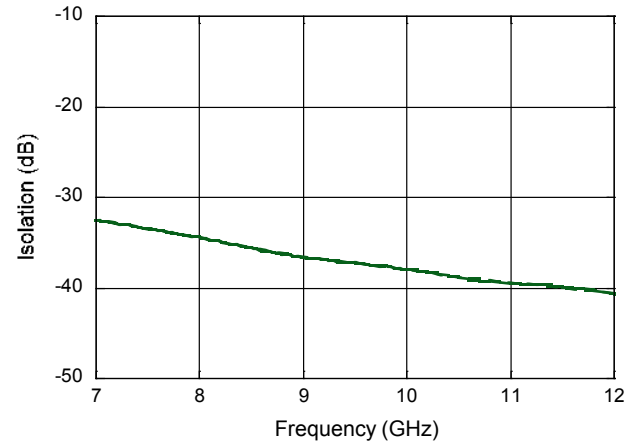

**Input Return Loss vs. Frequency  
Transmission, +/-5V**

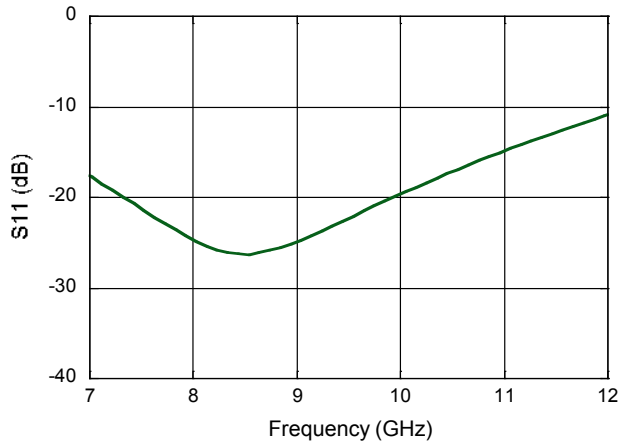

**Output Return Loss vs. Frequency  
Termination, +5V**

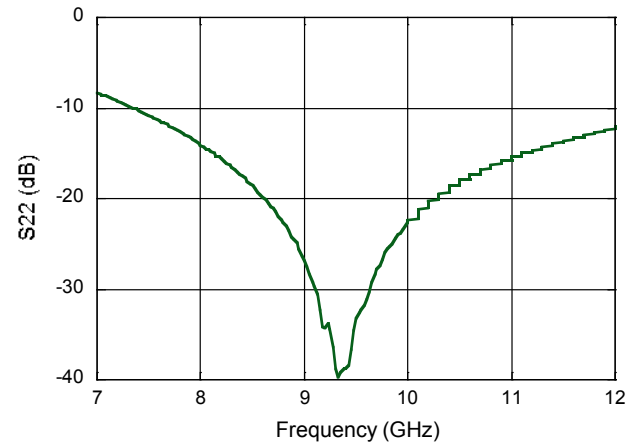

## 20 W HMIC Silicon PIN Diode Terminated SPDT Switch 8.0 - 10.5 GHz

Rev. V1

### Typical Measured Large Signal Performance

**Insertion Loss vs. Bias Voltage**  
9.5 GHz, 43 dBm CW

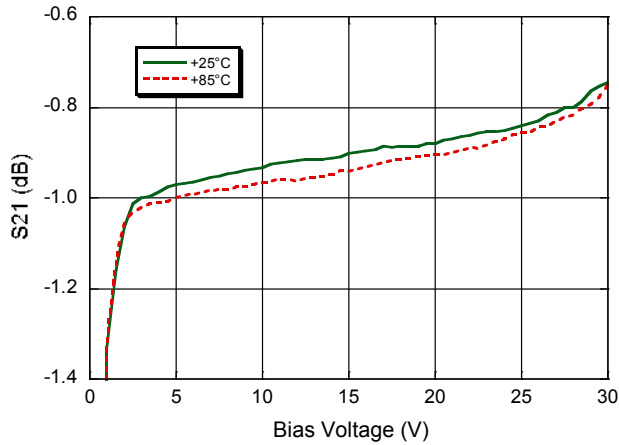

**Insertion Loss vs. CW Power**  
9.5 GHz, -30 V

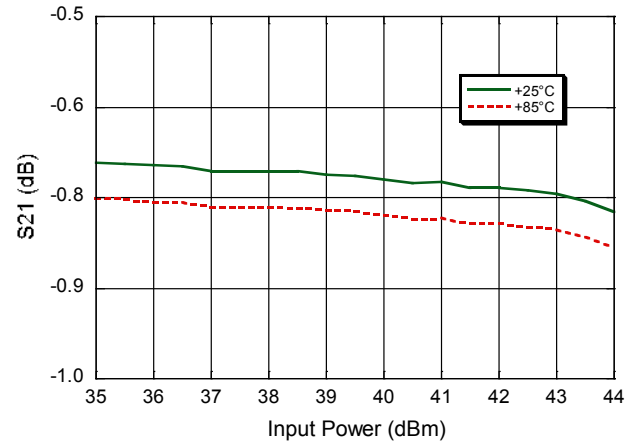

### Outline Drawing

All dimensions shown in microns ( $\mu\text{m}$ ).  
Thickness is  $125 \pm 10 \mu\text{m}$ .

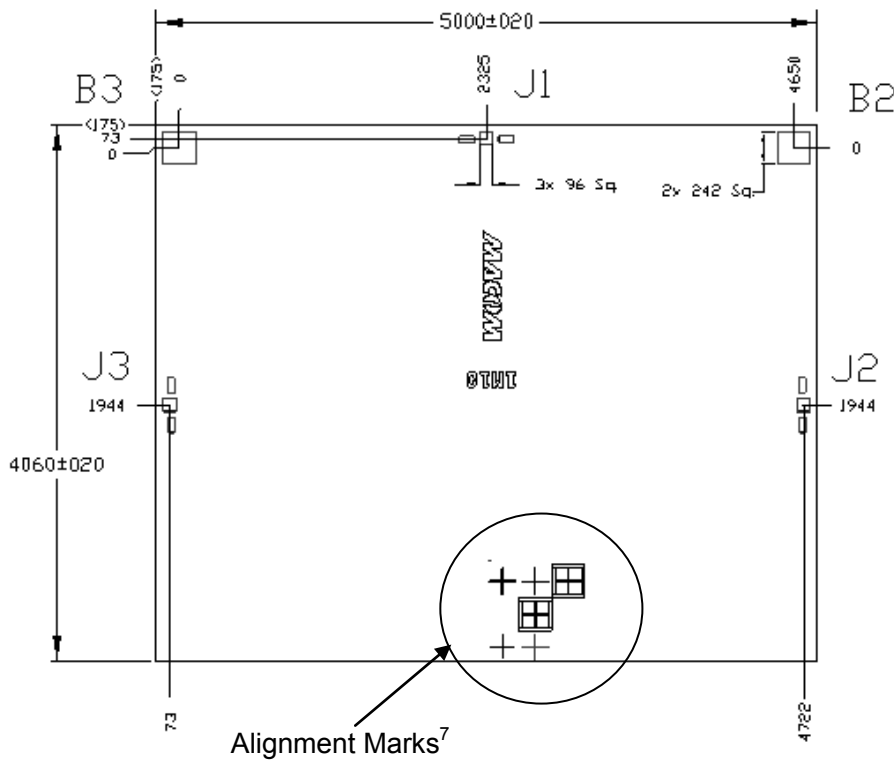

7. Most switches will not have the alignment marks pictured above. Switches with alignment marks have the same quality and reliability rating as switches without the alignment marks and cannot be returned as defective.