

Switch, Symmetrical SP3T 100 Watt Reflective 0.05 - 2.5 GHz

Preliminary- Rev. V4P

Features

- Suitable for High Power Military and Civilian Radio Applications
- Power Handling: 100 W C.W. @ 85°C
- Insertion Loss: 0.45 dB @ 2 GHz
- Isolation: 27 dB @ 2 GHz
- Surface Mount 7mmPQFN-16LD Package
- RoHS* Compliant and 260°C Reflow Compatible
- Class 1B ESD Rating

Description

The MASW-011032 is a symmetrical high power series-shunt silicon PIN diode SP3T switch in a common cathode configuration, operating from 50 MHz to 2.5 GHz. It features low insertion loss and excellent linearity with low DC consumption. This device is capable of handling 100 W C.W. of incident power at a base plate temperature of 85° C. This device is ideal for use on land mobile radio and MIL-COM applications requiring higher CW and pulsed power operation.

The MASW-011032 is manufactured using M/A-COM Technology Solutions' hybrid manufacturing process featuring high voltage PIN diodes and passive devices integrated in a 7 mm PQFN 16-lead plastic package.

Functional Schematic

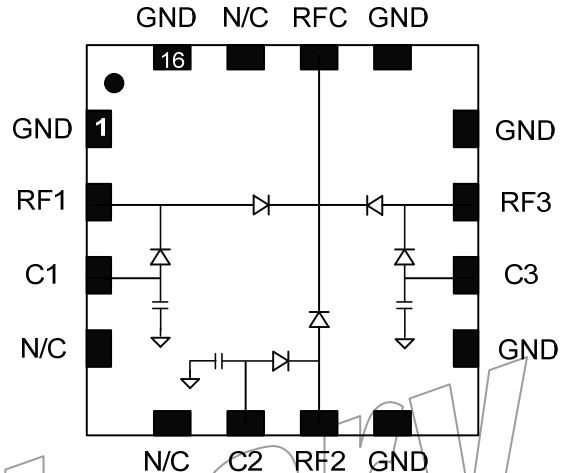

Pin Configuration

Pin	Function	Pin	Function
1	GND	9	GND
2	RF1	10	C3
3	C1	11	RF3
4	N/C	12	GND
5	N/C	13	GND
6	C2	14	RFC
7	RF2	15	N/C
8	GND	16	GND
		Paddle ²	Ground

2. The exposed paddle centered on the package bottom must be connected to RF, DC and thermal ground.

Ordering Information¹

Part Number	Package
MASW-011032-000PPR	Tape and Reel (1K)
MASW-011032-SMBPPR	Sample Board

1. Reference Application Note M513 for reel size information.

* Restrictions on Hazardous Substances, European Union Directive 2002/95/EC.

Switch, Symmetrical SP3T 100 Watt Reflective 0.05 - 2.5 GHz

Preliminary- Rev. V4P

Electrical Specifications: $T_A = 25^\circ\text{C}$, Bias = +5 / -5 V³, 100 mA

Parameter	Test Conditions	Units	Min.	Typ.	Max.
Insertion Loss ³ Pin = 0 dBm	0.5 GHz 1 GHz 2 GHz	dB	—	0.2 0.3 0.45	—
Isolation ³ Pin = 0 dBm	0.5 GHz 1 GHz 2 GHz	dB	—	30 30 27	—
Input Return Loss ³	Pin = 0 dBm	dB	—	>15	—
C.W. Input Power ⁴	25°C Base plate, 2 GHz	dBm W	—	52 158	—
C.W. Input Power ⁴	85°C Base plate, 2 GHz	dBm W	—	50 100	—
P0.1dB ⁴	25°C Base plate, 2 GHz	dBm	—	>52	—
Input IP3 ⁴	F1 = 2000 MHz, F2 = 2010 MHz Pin = 40 dBm/Tone	dBm	—	77	—
RF Switching Speed	(10-90% RF Voltage) 1 MHz Rep Rate in Modulating Mode	ns	—	250	—

3. See Bias table.

Bias (+5V/-5V)

RF State	V1 Bias (Volts)	V2 Bias (Volts)	V3 Bias (Volts)	B1 Bias (Volts)	B2 Bias (Volts)	B3 Bias (Volts)	V4 Bias (Volts)
RFC - RF1 Low Loss RFC - RF2 Isolation RFC - RF3 Isolation	+5	-5	-5	0	0	0	0
RFC - RF2 Low Loss RFC - RF1 Isolation RFC - RF3 Isolation	-5	+5	-5	0	0	0	0
RFC - RF3 Low Loss RFC - RF1 Isolation RFC - RF2 Isolation	-5	-5	+5	0	0	0	0

4. D.C. reverse bias of a PIN Diode operating at a high power is dependent on RF Frequency, Incident Power, and VSWR. See Minimum Reverse DC Voltage table for high power operation.

Minimum Reverse DC Voltage⁵

Frequency (MHz)	Minimum Reverse DC Voltage
100	-117 V
200	-110 V
300	-101 V
500	-82 V
1000	-51 V
1500	-36 V
2000	-28 V

5. Required to maintain low loss under 100 W of incident power with 1.5:1 VSWR

Absolute Maximum Ratings^{6,7}

Parameter	Absolute Maximum
Forward Current	200 mA
Reverse Voltage (RF & D.C.)	-400 V
Operating Temperature	-40 °C to +85 °C
Storage Temperature	-55 °C to +150 °C
Junction Temperature	+175 °C

6. Exceeding any one or combination of these limits may cause permanent damage to this device.
7. M/A-COM Technology Solutions does not recommend sustained operation near these survivability limits.

Handling Procedures

Please observe the following precautions to avoid damage:

Static Sensitivity

Silicon Integrated Circuits are sensitive to electrostatic discharge (ESD) and can be damaged by static electricity. Proper ESD control techniques should be used when handling these Class 1B devices.

Application Schematic

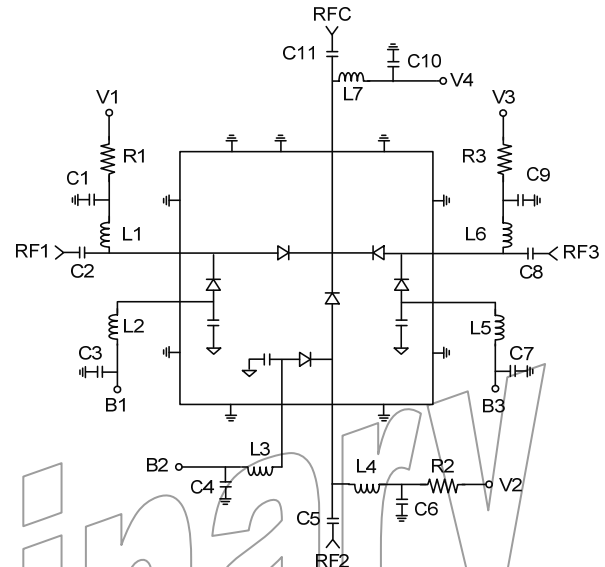

Off-Chip Component Values (400 MHz - 2.5 GHz)

Component	Value (Positive Bias)	Size
C1, C3, C4, C6, C7, C9, C10	270 pF	0603
C2, C5, C8, C11	27 pF	0603
L1 - L7	82 nH	0603
R1 - R3	39 Ω ⁸	1210

8. Resistance values are used for small signal testing under +5V/-5 V bias conditions.

Switch, Symmetrical SP3T 100 Watt Reflective 0.05 - 2.5 GHz

Preliminary- Rev. V4P

Typical Performance Curves: Bias = +5 / -5 V³, 100 mA

Insertion Loss (using external Bias T (ZFBT-4R2G))

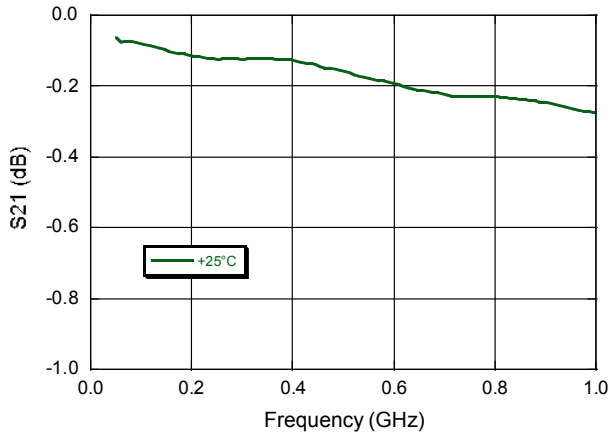

Insertion Loss (using off-chip components)

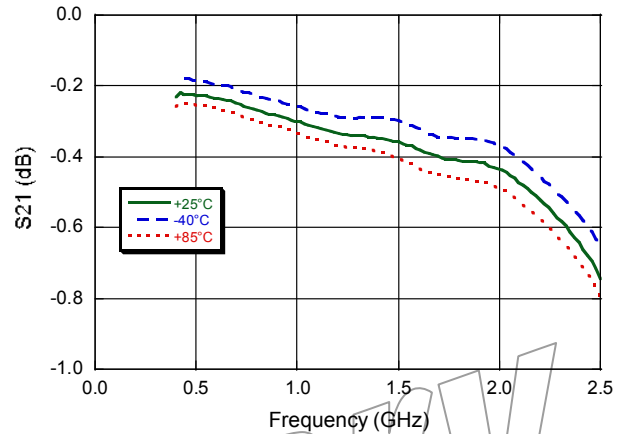

Isolation (using external Bias T (ZFBT-4R2G))

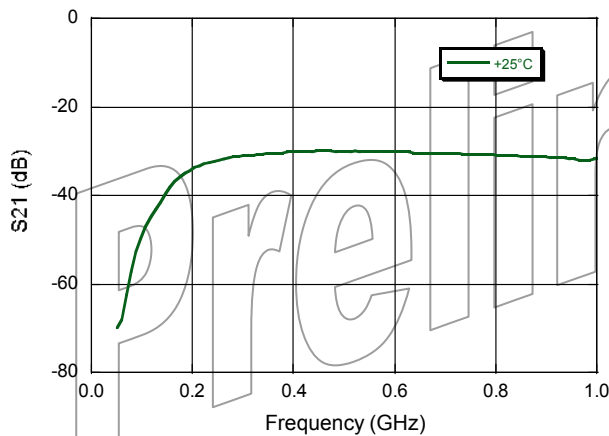

Isolation (using off-chip components)

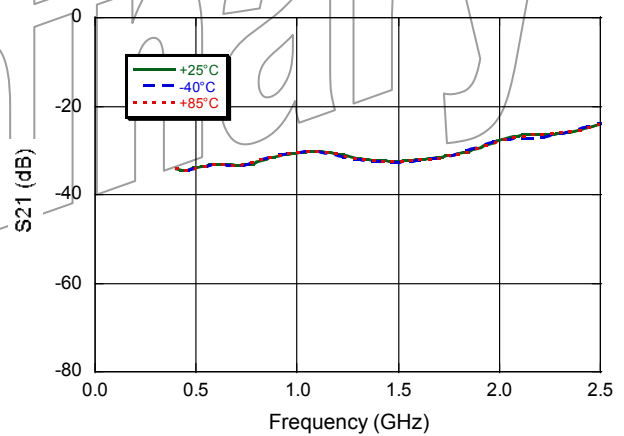

Return Loss (using external Bias T (ZFBT-4R2G))

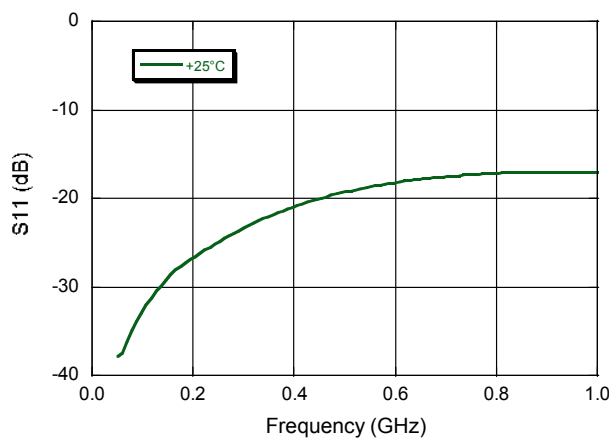

Return Loss (using off-chip components)

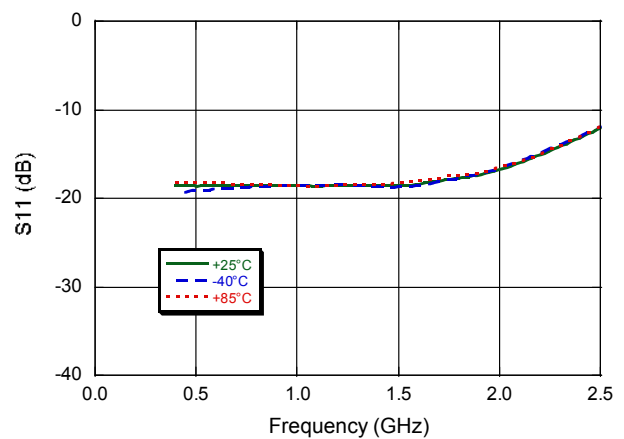

ADVANCED: Data Sheets contain information regarding a product M/A-COM Technology Solutions is considering for development. Performance is based on target specifications, simulated results, and/or prototype measurements. Commitment to develop is not guaranteed.
PRELIMINARY: Data Sheets contain information regarding a product M/A-COM Technology Solutions has under development. Performance is based on engineering tests. Specifications are typical. Mechanical outline has been fixed. Engineering samples and/or test data may be available. Commitment to produce in volume is not guaranteed.

• **North America** Tel: 800.366.2266 • **Europe** Tel: +353.21.244.6400
 • **India** Tel: +91.80.43537383 • **China** Tel: +86.21.2407.1588
 Visit www.macomtech.com for additional data sheets and product information.

M/A-COM Technology Solutions Inc. and its affiliates reserve the right to make changes to the product(s) or information contained herein without notice.

Switch, Symmetrical SP3T 100 Watt Reflective
0.05 - 2.5 GHz

Preliminary- Rev. V4P

Lead Free 7 mm 16-Lead PQFN †

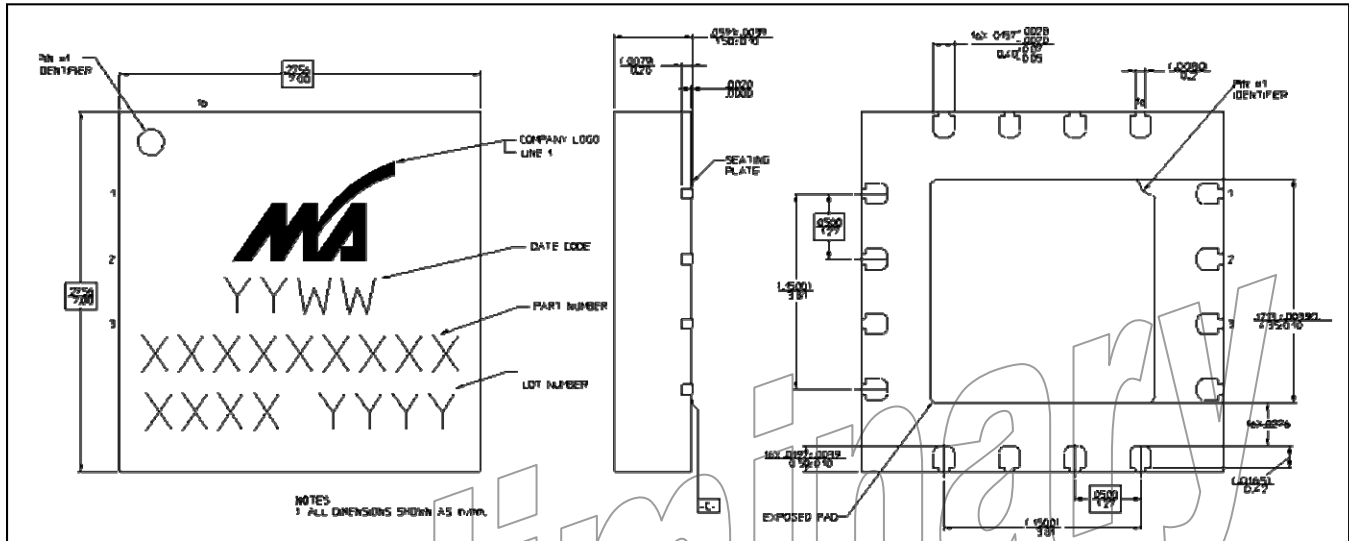

† Reference Application Note S2083 for lead-free solder reflow recommendations.
Meets JEDEC moisture sensitivity level 1 requirements.
Plating is 100% matte tin over copper.