

GaAs SPDT 2.7 V High Power Switch DC - 3.0 GHz

MASWSS0117
V2

Features

- Low Voltage Operation: 2.7 V
- High IP3: +56 dBm
- Low Insertion Loss: 0.30 dB at 1 GHz
- High Isolation: 25 dB at 1 GHz
- SC70 6-Lead Package
- 0.5 micron GaAs PHEMT Process

Description

M/A-COM's MASWSS0117 is a GaAs PHEMT MMIC single pole double throw (SPDT) high power switch in a low cost SC70 6-lead package. The MASWSS0117 is ideally suited for applications where high power, low control voltage, low insertion loss, high isolation, small size and low cost are required.

Typical applications are for CDMA handset systems that connect separate transceiver and/or GPS functions to a common antenna, as well as other related handset and general purpose applications. The MASWSS0117 can be used in all systems operating up to 3.0 GHz requiring high power at low control voltage.

The MASWSS0117 is fabricated using a 0.5 micron gate length GaAs PHEMT process. The process features full passivation for performance and reliability.

Functional Block Diagram

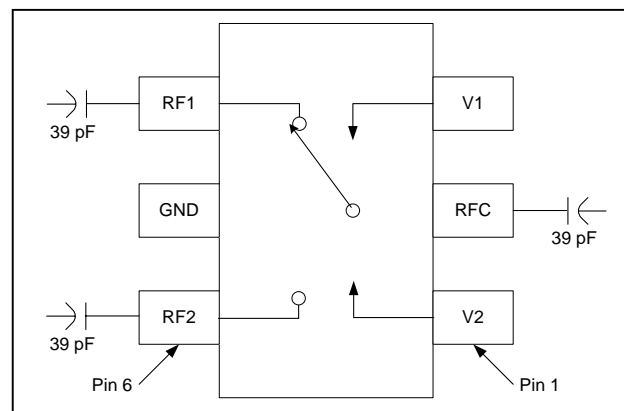

Pin Configuration

Pin No.	Pin Name	Description
1	V2	Vcontrol 2
2	RFC	RF Common
3	V1	Vcontrol 1
4	RF1	RF Port 1
5	GND	RF Ground
6	RF2	RF Port 2

MASWSS0117 orientation in tape

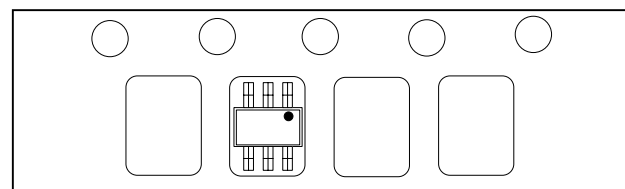

MASWSS0117 Device Marking

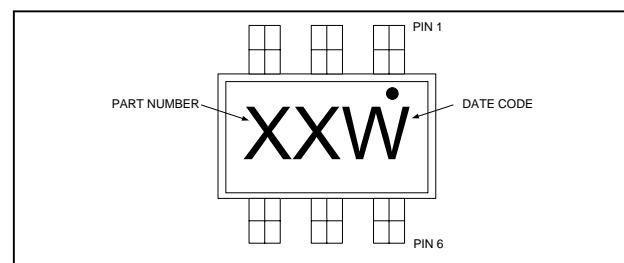

Ordering Information¹

Part Number	Package
MASWSS0117	Bulk Packaging
MASWSS0117TR	1000 piece reel
MASWSS0117TR-3000	3000 piece reel
MASWSS0117SMB	Sample Test Board

1. Reference Application Note M513 for reel size information.

GaAs SPDT 2.7 V High Power Switch
DC - 3.0 GHz

MASWSS0117
V2

Electrical Specifications: $T_A = 25^\circ\text{C}$, $V_C = 0\text{ V} / 2.7\text{ V}$, $Z_0 = 50\ \Omega$ ²

Parameter	Test Conditions	Units	Min.	Typ.	Max.
Insertion Loss ³	DC – 1 GHz	dB	—	0.30	0.65
	1 – 2 GHz	dB	—	0.35	—
	2 - 3 GHz	dB	—	0.35	—
Isolation	DC – 1 GHz	dB	23	25	—
	1 – 2 GHz	dB	—	19	—
	2 - 3 GHz	dB	—	15	—
Return Loss	DC – 3 GHz	dB	—	20	—
IP3	825 MHz Two Tone, +24 dBm Total Pin, 5 MHz Spacing	dBm	—	56	—
Cross Modulation	For Cell Band: Two-tone signal input: Tx1 = +22 dBm @ 820 MHz, Tx2 = +22 dBm @ 821 MHz, RX interfere = -23 dBm @ 869 MHz.	dBm	—	-99	—
	For PCS Band: Two-tone signal input: Tx1 = +18 dBm @ 1880 MHz, Tx2 = +18 dBm @ 1881 MHz, RX interfere = -23 dBm @ 1960 MHz.	dBm	—	-94	—
P0.1dB	1.0 GHz	dBm	—	38	—
Trise, Tfall	10% to 90% RF, 90% to 10% RF	nS	—	70	—
Ton, Toff	50% control to 90% RF 50% control to 10% RF	nS	—	100	—
Transients	In Band	mV	—	25	—
Control Current	$V_C = 2.7\text{ V}$	μA	—	5	20

2. For positive voltage control, external DC blocking capacitors are required on all RF ports.
3. Insertion loss can be optimized by varying the DC blocking capacitor value, e.g. 1000 pF for 100 MHz - 1 GHz, 39 pF for 0.5 - 3 GHz.

Absolute Maximum Ratings ^{4,5}

Parameter	Absolute Maximum
Input Power (0.5 - 3 GHz, 3 V Control)	+38 dBm
Operating Voltage	+8.5 volts
Operating Temperature	-40°C to +85°C
Storage Temperature	-65°C to +150°C

4. Exceeding any one or combination of these limits may cause permanent damage to this device.
5. M/A-COM does not recommend sustained operation near these survivability limits.

Truth Table ^{6,7,8}

V1	V2	ANT– RF1	ANT - RF2
1	0	On	Off
0	1	Off	On

6. For positive voltage control, external DC blocking capacitors are required on all RF ports.
7. Differential voltage, V (state 1) - V (state 0), must be +2.7 V minimum, but must not exceed 8.5 V.
8. 0 = -5 V to +2.3 V, 1 = -2.3 V to +5 V.

**GaAs SPDT 2.7 V High Power Switch
DC - 3.0 GHz**

MASWSS0117
V2

Typical Performance Curves vs. Frequency, 39 pF

Insertion Loss

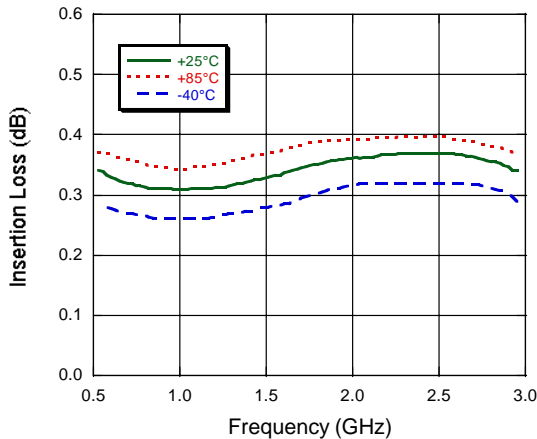

Isolation

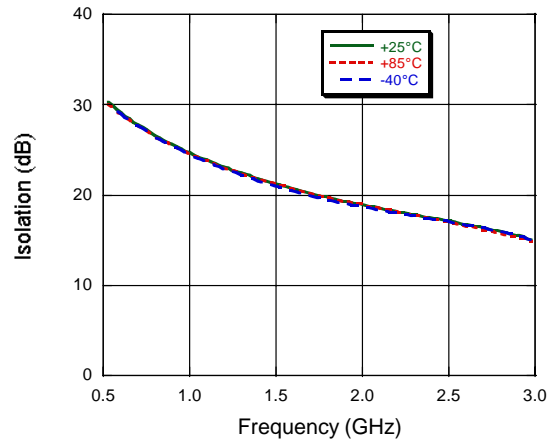

Return Loss

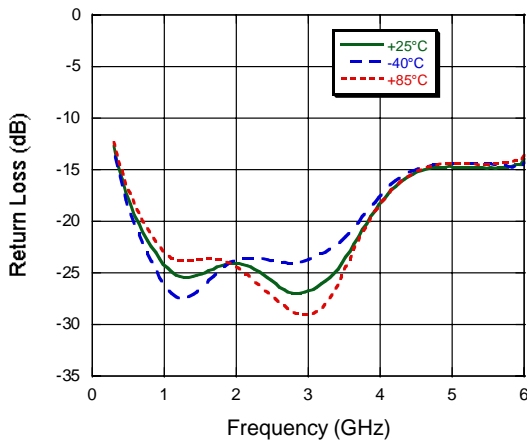

Qualification

Qualified to M/A-COM specification REL-201, Process Flow -2.

Handling Procedures

Please observe the following precautions to avoid damage:

Static Sensitivity

Gallium Arsenide Integrated Circuits are sensitive to electrostatic discharge (ESD) and can be damaged by static electricity. Proper ESD control techniques should be used when handling these devices.

SC-70 Plastic Package†

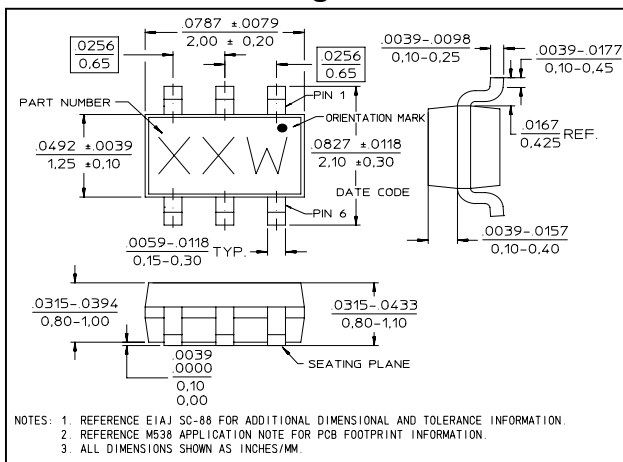

†Meets JEDEC moisture sensitivity level 1 requirements.