

**SPDT High Isolation Terminated Switch**  
 0.01 - 3.0 GHz

**MASWSS0178**  
**V3**
**Features**

- Positive Voltage Control: 0 / +5 V
- High Isolation: 55 dB @ 0.9 GHz  
50 dB @ 1.9 GHz
- 50 Ω Internal Terminations
- Low Insertion Loss: 0.6 dB @ 0.9 GHz  
0.7 dB @ 1.9 GHz
- Lead-Free MSOP-8-EP Package
- 100% Matte Tin Plating over Copper
- Halogen-Free "Green" Mold Compound
- 260°C Reflow Compatible
- RoHS\* Compliant Version of MASWSS0024

**Description**

The M/A-COM MASWSS0178 GaAs monolithic switch provides high isolation in a lead-free, plastic surface mount package.

The MASWSS0178 is ideal for applications across a broad range of frequencies including synthesizer switching, transmit / receive switching, switch matrices and filter banks in systems such as radio and cellular equipment, PCS, GPS, and fiber optic modules.

M/A-COM fabricates the MASWSS0178 using a 1.0-micron gate length MESFET process. The process features full chip passivation for performance and reliability.

**Ordering Information**<sup>1</sup>

Part Number	Package
MASWSS0178	Bulk Packaging
MASWSS0178TR-3000	3000 piece reel
MASWSS0178SMB	Sample Board

1. Reference Application Note M513 for reel size information.

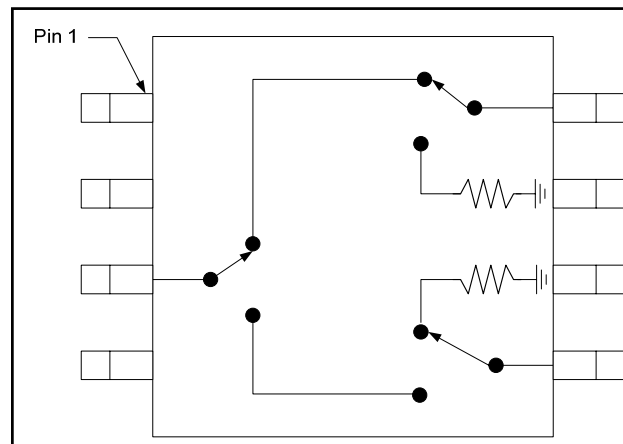
**Functional Block Diagram**

**Pin Configuration**<sup>2</sup>

Pin	Function	Pin	Function
1	Control 1	5	RF Port 2
2	Control 2	6	Ground
3	RF Common	7	Ground
4	Ground	8	RF Port 1

2. The exposed pad centered on the package bottom must be connected to RF and DC ground.

**Absolute Maximum Ratings**<sup>3,4</sup>

Parameter	Absolute Maximum
Input Power (0.5 - 3.0 GHz) 3 V Control 5 V Control	+30 dBm +33 dBm
Operating Voltage	+8.5 Volts
Operating Temperature	-40°C to +85°C
Storage Temperature	-65°C to +150°C

3. Exceeding any one or combination of these limits may cause permanent damage to this device.

4. M/A-COM does not recommend sustained operation near these survivability limits.

\* Restrictions on Hazardous Substances, European Union Directive 2002/95/EC.

**SPDT High Isolation Terminated Switch**  
0.01 - 3.0 GHz

MASWSS0178  
V3

**Electrical Specifications:  $T_A = 25^\circ\text{C}$ ,  $V_C = 0\text{ V} / 5\text{ V}$ ,  $Z_0 = 50\ \Omega$ <sup>5</sup>**

Parameter	Test Conditions	Units	Min.	Typ.	Max.
Insertion Loss	0.01 - 0.5 GHz	dB	—	0.5	—
	0.5 - 1.0 GHz	dB	—	0.6	0.7
	1.0 - 2.0 GHz	dB	—	0.7	0.8
	2.0 - 3.0 GHz	dB	—	0.75	—
Isolation	0.01 - 0.5 GHz	dB	—	59	—
	0.5 - 1.0 GHz	dB	51	57	—
	1.0 - 2.0 GHz	dB	44	53	—
	2.0 - 3.0 GHz	dB	—	43	—
Return Loss	0.01 - 0.5 GHz <sup>6</sup>	dB	—	20	—
	0.5 - 1.0 GHz	dB	—	20	—
	1.0 - 2.0 GHz	dB	—	20	—
	2.0 - 3.0 GHz	dB	—	20	—
Input IP <sub>2</sub>	2-Tone, 900 MHz, 5 MHz spacing	dBm	—	83	—
Input IP <sub>3</sub>	2-Tone, 900 MHz, 5 MHz spacing	dBm	—	43	—
Trise, Tfall	10% to 90% RF & 90% to 10% RF	nS	—	24	—
Ton, Toff	50% of V <sub>C</sub> to 10% / 90% RF	nS	—	15	—
Transients	In-band	mV	—	12	—
Control Current	V <sub>C</sub>   = 5 V	μA	—	2	13

5. External DC blocking capacitors are required on all RF ports (47 pF capacitors are recommended). Use larger value capacitors for lower frequency operation (e.g. use 10,000 pF capacitors to optimize insertion and return loss at frequencies below 50 MHz).

6. Terminated return loss is governed by blocking capacitors internal to the device; see applications plot.

**Truth Table**

V1	V2	RFC-RF1	RFC-RF2
0	1	Off	On
1	0	On	Off

Logic Level	Voltage Level
V <sub>LOW</sub> "0"	0 ± 0.2 V
V <sub>HIGH</sub> "1"	3.0 V to 8.0 V

**Handling Procedures**

Please observe the following precautions to avoid damage:

**Static Sensitivity**

Gallium Arsenide Integrated Circuits are sensitive to electrostatic discharge (ESD) and can be damaged by static electricity. Proper ESD control techniques should be used when handling these devices.

**SPDT High Isolation Terminated Switch  
0.01 - 3.0 GHz**

**MASWSS0178  
V3**

**Typical Performance Curves**

**Return Loss**

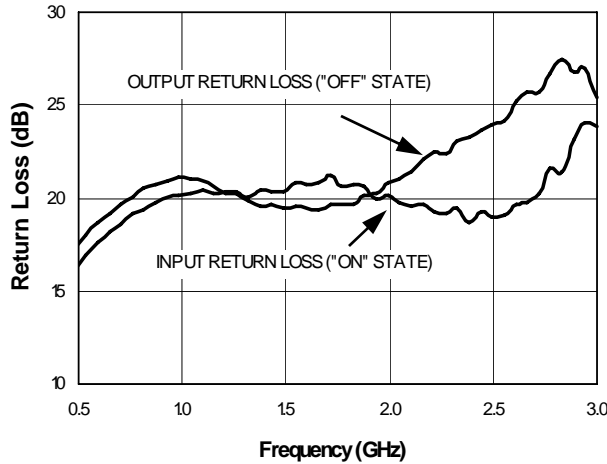

**Insertion Loss**

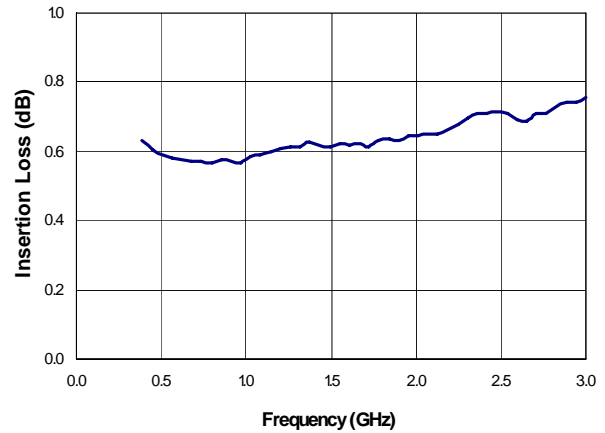

**Isolation**

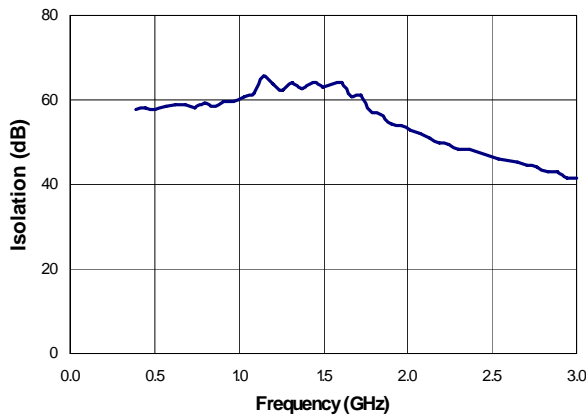

**Lead-Free MSOP-8-EP†**

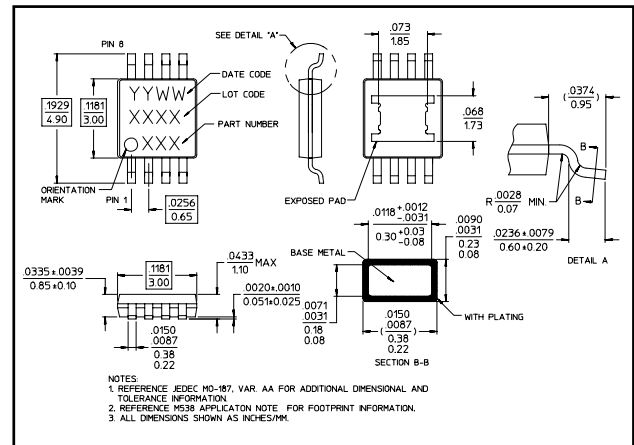

† Reference Application Note M538 for lead-free solder reflow recommendations.

**Applications Section**

**Typical Performance Curves, Very Low Frequency, 10000 pF Blocking Capacitors**

*Return Loss vs. Frequency*

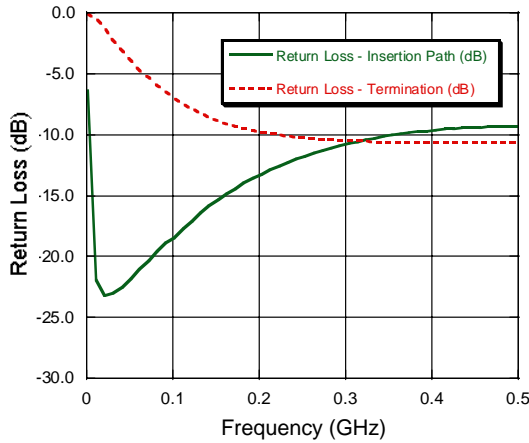

*Insertion Loss vs. Frequency*

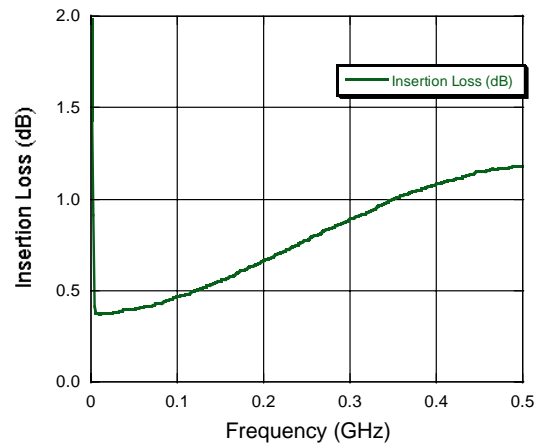

*Isolation vs. Frequency*

