



1.7GHz to 2.5GHz, Direct I/Q Modulator with VGA and PA Driver

General Description

The MAX2720/MAX2721 are low-cost, high-performance, direct I/Q modulators designed for use in wideband-CDMA and wireless local-loop (WLL) systems. Their direct-upconversion architecture reduces system cost, component count, and board space compared to devices with dual-conversion architectures.

The MAX2720/MAX2721 include an I/Q modulator, a variable gain amplifier (VGA), and a power amplifier (PA) driver. The quadrature modulator accepts differential baseband I/Q signals and directly modulates an RF carrier in the 1.7GHz to 2.1GHz range (MAX2720) or the 2.1GHz to 2.5GHz range (MAX2721). The VGA provides 35dB of output power control. The modulator's amplitude and phase balance yield 35dBc of sideband suppression and 30dBc of carrier suppression. These devices feature an LO frequency doubler that allows the external LO source to operate at half-frequency or full-frequency when disabled.

The MAX2720/MAX2721 operate from a single +2.7V to +3.3V supply and require only 77mA (MAX2720) or 86mA (MAX2721) of supply current. An additional 20mA of supply current is saved by disabling the stand-alone PA driver. A low-power shutdown mode further reduces supply current to less than 0.1µA. The device is packaged in the small 20-pin TSSOP-EP with exposed paddle to improve RF performance.

Applications

Wireless Local Loop (WLL)
Wideband CDMA Systems
LMDS/MMDS
2.4GHz Broadband ISM Radios
DCS/PCS Base Stations

Pin Configuration appears at end of data sheet.

Features

- ◆ RF Frequency Range
 - 1.7GHz to 2.1GHz (MAX2720)
 - 2.1GHz to 2.5GHz (MAX2721)
- ◆ Integrated I/Q Modulator, LO Doubler, VGA, and PA Driver
- ◆ 35dB VGA Gain Control Range
- ◆ 35dBc Sideband Suppression
- ◆ 30dBc Carrier Suppression
- ◆ Low Supply Current
 - 77mA (MAX2720), 86mA (MAX2721)
 - 20mA Reduction with PA Driver Disabled
- ◆ 0.1µA Supply Current in Shutdown Mode
- ◆ +2.7V to +3.3V Single-Supply Operation

Ordering Information

PART	TEMP. RANGE	PIN-PACKAGE
MAX2720EUP	-40°C to +85°C	20 TSSOP-EP*
MAX2721EUP	-40°C to +85°C	20 TSSOP-EP*

*Exposed paddle.

Functional Diagram

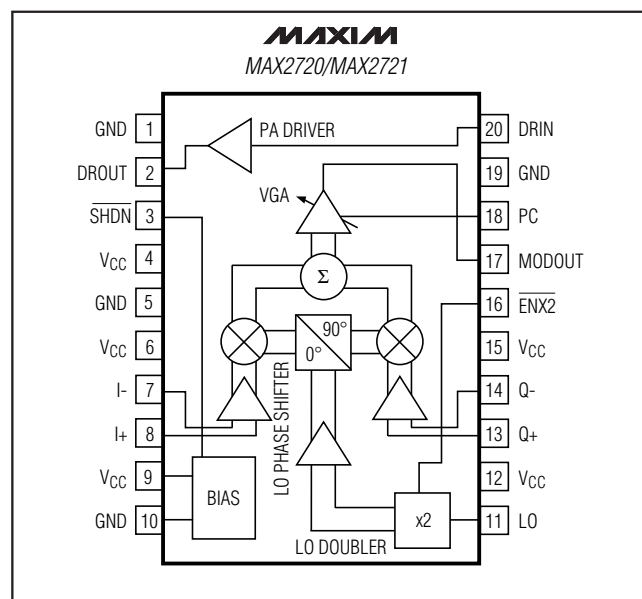

1.7GHz to 2.5GHz, Direct I/Q Modulator with VGA and PA Driver

ABSOLUTE MAXIMUM RATINGS

V _{CC} to GND	-0.3V to +6V
ENX2, SHDN, PC, I+, I-, Q+, Q-, LO, DRIN to GND	-0.3V to (V _{CC} + 0.3V)
ENX2, SHDN Continuous Current	±10mA
PC Continuous Current	±10mA
I+ to I-, Q+ to Q-	±2V
MODOUT, DROUT to GND Short-Circuit Duration	10s

Continuous Power Dissipation (T _A = +70°C) 20-Pin TSSOP-EP (derate 21.7mW/°C above +70°C)	1.74W
Operating Temperature Range	-40°C to +85°C
Junction Temperature	+150°C
Storage Temperature Range	-65°C to +150°C
Lead Temperature (soldering 10s)	+300°C

Stresses beyond those listed under "Absolute Maximum Ratings" may cause permanent damage to the device. These are stress ratings only, and functional operation of the device at these or any other conditions beyond those indicated in the operational sections of the specifications is not implied. Exposure to absolute maximum rating conditions for extended periods may affect device reliability.

DC ELECTRICAL CHARACTERISTICS

(V_{CC} = +2.7V to +3.3V; SHDN = V_{CC}; ENX2 = GND; V_{PC} = 0.5V; no input AC signals applied to I+, I-, Q+, Q-, LO, DRIN, MODOUT and DROUT = V_{CC}, T_A = -40°C to +85°C. Typical values are at V_{CC} = +3V, T_A = +25°C, unless otherwise noted.)

PARAMETER	CONDITIONS	MIN	TYP	MAX	UNITS
Supply Voltage		2.7		3.3	V
Supply Current	MAX2720		77	119	mA
	MAX2721		86	129	
Supply Current with PA Driver Disabled	MAX2720, DRIN = GND		59	86	mA
	MAX2721, DRIN = GND		67	96	
Shutdown Supply Current	SHDN = GND		0.1	10	μA
Logic Input High Voltage		2.0			V
Logic Input Low Voltage				0.5	V
Logic Input Bias Current		-1		1	μA
PC Input Bias Current	0.5V < V _{PC} < 2.5V	-5		5	μA
	0.5V < V _{PC} < 2.5V, SHDN = GND		2.5		

AC ELECTRICAL CHARACTERISTICS

(MAX2720/MAX2721 EV Kit, V_{CC} = +3.0V, SHDN = V_{CC}, ENX2 = GND, V_{PC} = 2.5V, input I/Q signals driven in quadrature, from a 1kΩ source impedance, single-ended, f_{I+} = f_{Q+} = 500kHz, V_{I+} = V_{Q+} = 200mVp-p, P_{LO} = -13dBm, f_{LO} = 950MHz (MAX2720), f_{LO} = 1157.5MHz (MAX2721), P_{DRIN} = -12dBm, f_{DRIN} = 1900MHz (MAX2720), f_{DRIN} = 2315MHz (MAX2721), MODOUT and DROUT ports are matched to a 50Ω load, T_A = +25°C, unless otherwise noted.) (Note 1)

PARAMETER	CONDITIONS	MIN	TYP	MAX	UNITS
I/Q BASEBAND INPUTS					
I/Q Input -1dB Bandwidth (Note 2)		14	20		MHz
I/Q Input -3dB Bandwidth (Note 2)			40		MHz
I/Q Differential Input Level			200	630	mVp-p
I/Q Gain Imbalance	f _I = f _Q < BW _{-3dB} , 0.5V < V _{PC} < 2.5V		±0.2		dB
I/Q Phase Imbalance	f _I = f _Q < BW _{-3dB} , 0.5V < V _{PC} < 2.5V		±1.0		degrees
I/Q Input Resistance	f _I = f _Q < BW _{-1dB}	1.6	2.0		kΩ
I/Q Input Resistance Mismatch	f _I = f _Q < BW _{-1dB}		18		Ω
I/Q Input Capacitance	f _I = f _Q < BW _{-1dB}		5		pF
Group Delay Ripple	100kHz < f _{I+} = f _{Q+} < 2MHz		1		ns
Group Delay Mismatch	100kHz < f _I = f _Q < 2MHz		1		ns

1.7GHz to 2.5GHz, Direct I/Q Modulator with VGA and PA Driver

MAX2720/MAX2721

AC ELECTRICAL CHARACTERISTICS (continued)

(MAX2720/MAX2721 EV Kit, $V_{CC} = +3.0V$, $\overline{SHDN} = V_{CC}$, $\overline{ENX2} = GND$, $V_{PC} = 2.5V$, input I/Q signals driven in quadrature, from a $1k\Omega$ source impedance, single-ended, $f_{I+} = f_{Q+} = 500kHz$, $V_{I+} = V_{Q+} = 200mVp-p$, $P_{LO} = -13dBm$, $f_{LO} = 950MHz$ (MAX2720), $f_{LO} = 1157.5MHz$ (MAX2721), $P_{DRIN} = -12dBm$, $f_{DRIN} = 1900MHz$ (MAX2720), $f_{DRIN} = 2315MHz$ (MAX2721), MODOUT and DROUT ports are matched to a 50Ω load, $T_A = +25^\circ C$, unless otherwise noted.) (Note 1)

PARAMETER	CONDITIONS		MIN	TYP	MAX	UNITS
MODULATOR OUTPUT						
Frequency Range (Note 3)	MAX2720		1700		2100	MHz
	MAX2721		2100		2500	
Output Power, High	MAX2720, $V_{PC} = 2.5V$, $\overline{ENX2} = V_{CC}$ or GND, $T_A = +25^\circ C$ (Note 3)		-12.5	-8.5	-6.0	dBm
	MAX2721, $V_{PC} = 2.5V$, $\overline{ENX2} = V_{CC}$ or GND, $T_A = +25^\circ C$ (Note 3)		-10.5	-5.0	-2.5	
Output Power Variation Over Temperature	$V_{PC} = 2.5V$, $T_A = -40^\circ C$ to $+85^\circ C$	MAX2720		± 1.0	± 1.8	dB
		MAX2721		± 0.8	± 1.5	
Power Control Range	$V_{PC} = 0.5V$, $\overline{ENX2} = V_{CC}$ or GND	MAX2720	29	35		dB
		MAX2721	28	32		
PC Slope	Slope between $V_{PC} = 1V$ and $V_{PC} = 2V$			19	23	dB/V
Output 1dB Compression Point	$V_{PC} = 2.5V$	MAX2720	+1	+5		dBm
		MAX2721	+3	+6		
Output Third-Order Intercept Point (Note 4)	$V_{PC} = 2.5V$	MAX2720	+8	+14		dBm
		MAX2721	+9	+14		
Output VSWR	$0.5V < V_{PC} < 2.5V$			2:1		
Out-of-Band Noise Density	$V_{PC} = 2.5V$, I/Q terminated in 50Ω			-141	-137	dBm/Hz
Carrier Suppression	MAX2720, $0.5V < V_{PC} < 2.5V$		26	33		dBc
	MAX2721	$V_{PC} = 2.5V$	24	31		
		$V_{PC} = 0.5V$	20	25		
Sideband Suppression	$0.5V < V_{PC} < 2.5V$	MAX2720	30	40		dBc
		MAX2721	28	35		
MODOUT to LO Input Isolation				50	45	dB
Power-Supply Ripple Rejection (Note 5)	$V_{CC} = +3.0V + 100mVp-p$ at 10kHz/300kHz			41		dBc
LO BUFFER, LO FREQUENCY DOUBLER, QUADRATURE GENERATOR						
LO Frequency Range (Note 3)	MAX2720	$\overline{ENX2} = GND$	850		1050	MHz
		$\overline{ENX2} = V_{CC}$	1700		2100	
	MAX2721	$\overline{ENX2} = GND$	1050		1250	
		$\overline{ENX2} = V_{CC}$	2100		2500	
LO Input VSWR	MAX2720	$\overline{ENX2} = GND$		1.9:1		
		$\overline{ENX2} = V_{CC}$		1.8:1		
	MAX2721	$\overline{ENX2} = GND$		1.8:1		
		$\overline{ENX2} = V_{CC}$		1.6:1		
LO Input Power (Note 3)			-16	-10		dBm

1.7GHz to 2.5GHz, Direct I/Q Modulator with VGA and PA Driver

AC ELECTRICAL CHARACTERISTICS (continued)

(MAX2720/MAX2721 EV Kit, $V_{CC} = +3.0V$, $\overline{SHDN} = V_{CC}$, $\overline{ENX2} = GND$, $V_{PC} = 2.5V$, input I/Q signals driven in quadrature, from a $1k\Omega$ source impedance, single-ended, $f_{I+} = f_{Q+} = 500kHz$, $V_{I+} = V_{Q+} = 200mVp-p$, $P_{LO} = -13dBm$, $f_{LO} = 950MHz$ (MAX2720), $f_{LO} = 1157.5MHz$ (MAX2721), $P_{DRIN} = -12dBm$, $f_{DRIN} = 1900MHz$ (MAX2720), $f_{DRIN} = 2315MHz$ (MAX2721), MODOUT and DROUT ports are matched to a 50Ω load, $T_A = +25^\circ C$, unless otherwise noted.) (Note 1)

PARAMETER	CONDITIONS		MIN	TYP	MAX	UNITS
PA DRIVER						
Frequency Range (Note 6)	MAX2720		1700		2100	MHz
	MAX2721		2100		2500	
Gain (Note 6)	MAX2720		11	13.5	15.5	dB
	MAX2721		8.5	11.5	15.5	
Gain Variation Over Temperature	$T_A = -40^\circ C$ to $+85^\circ C$	MAX2720		± 0.4	± 0.8	dB
		MAX2721		± 0.3	± 0.8	
Noise Figure	MAX2720			2.4		dB
	MAX2721			2.6		
Output 1dB Compression Point	MAX2720		+9.5	+12.5		dBm
	MAX2721		+8	+11		
Output Third-Order Intercept Point	MAX2720 (Note 7)		+22	+24		dBm
	MAX2721 (Note 8)		+20	+24		
Reverse Isolation				19		dB
DROUT to LO Input Isolation				65		dB
Input VSWR				1.5:1		
Output VSWR				1.5:1		

Note 1: Min/max limits are guaranteed by design and characterization and are not production tested.

Note 2: I/Q input bandwidth is determined by the baseband source impedance and the I/Q input capacitance. The bandwidth can be increased by lowering the baseband source impedance.

Note 3: MODOUT output power specifications are met over this frequency range for $V_{PC} = 2.5V$ and $T_A = +25^\circ C$.

Note 4: IP3 measured with two tones, $f_1 = 500kHz$ and $f_2 = 600kHz$, at $100mVp-p$ each.

Note 5: Measured relative to desired upconverted signal level.

Note 6: DROUT gain specifications are met over this frequency range at $T_A = +25^\circ C$.

Note 7: IP3 measured with two tones, $f_1 = 1900MHz$ and $f_2 = 1901MHz$, at $-18dBm$ each.

Note 8: IP3 measured with two tones, $f_1 = 2315MHz$ and $f_2 = 2316MHz$, at $-18dBm$ each.

1.7GHz to 2.5GHz, Direct I/Q Modulator with VGA and PA Driver

Typical Operating Characteristics

(MAX2720/MAX2721 EV Kit, $V_{CC} = +3.0V$, $\overline{SHDN} = V_{CC}$, $\overline{ENX2} = GND$, $V_{PC} = 2.5V$, input I/Q signals driven in quadrature, from a $1k\Omega$ source impedance, single-ended, $f_{I+} = f_{Q+} = 500kHz$, $V_{I+} = V_{Q+} = 200mV_{p-p}$, $P_{LO} = -13dBm$, $f_{LO} = 950MHz$ (MAX2720), $f_{LO} = 1157.5MHz$ (MAX2721), $P_{DRIN} = -12dBm$, $f_{DRIN} = 1900MHz$ (MAX2720), $f_{DRIN} = 2315MHz$ (MAX2721), MODOUT and DROUT ports are matched to a 50Ω load, $T_A = +25^\circ C$, unless otherwise noted.) (Note 1)

MAX2720

SUPPLY CURRENT vs. SUPPLY VOLTAGE WITH PA DRIVER ENABLED

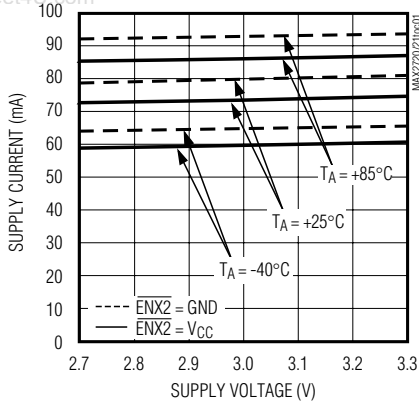

SUPPLY CURRENT vs. SUPPLY VOLTAGE WITH PA DRIVER DISABLED

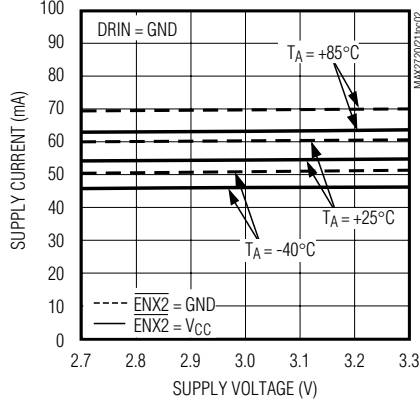

MODULATOR OUTPUT POWER vs. RF FREQUENCY

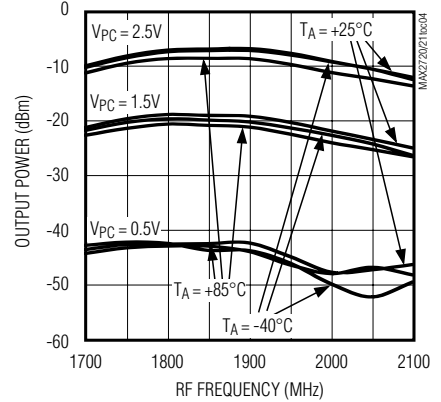

MODULATOR PERFORMANCE vs. LO POWER ($\overline{ENX2} = GND$)

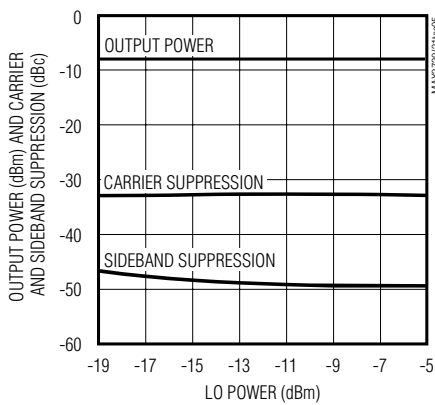

MODULATOR PERFORMANCE vs. LO POWER ($\overline{ENX2} = V_{CC}$)

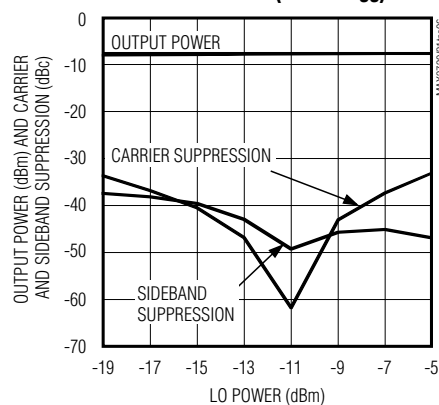

MAX2720/MAX2721

1.7GHz to 2.5GHz, Direct I/Q Modulator with VGA and PA Driver

Typical Operating Characteristics (continued)

(MAX2720/MAX2721 EV Kit, $V_{CC} = +3.0V$, $\overline{SHDN} = V_{CC}$, $\overline{ENX2} = GND$, $V_{PC} = 2.5V$, input I/Q signals driven in quadrature, from a $1k\Omega$ source impedance, single-ended, $f_{I+} = f_{Q+} = 500kHz$, $V_{I+} = V_{Q+} = 200mV_{p-p}$, $P_{LO} = -13dBm$, $f_{LO} = 950MHz$ (MAX2720), $f_{LO} = 1157.5MHz$ (MAX2721), $P_{DRIN} = -12dBm$, $f_{DRIN} = 1900MHz$ (MAX2720), $f_{DRIN} = 2315MHz$ (MAX2721), MODOUT and DROUT ports are matched to a 50Ω load, $T_A = +25^\circ C$, unless otherwise noted.) (Note 1)

MAX2720

MODULATOR OUTPUT POWER vs. PC VOLTAGE ($\overline{ENX2} = GND$)

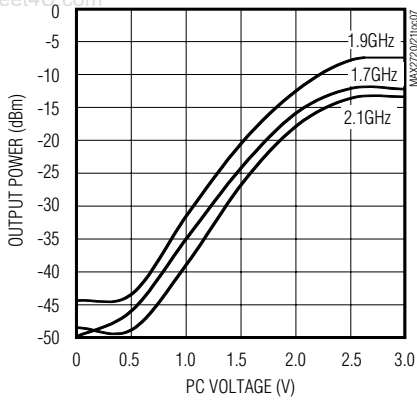

MODULATOR CARRIER SUPPRESSION vs. PC VOLTAGE ($\overline{ENX2} = GND$)

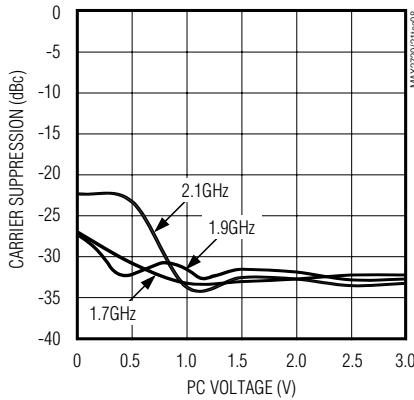

MODULATION SIDEBAND SUPPRESSION vs. PC VOLTAGE ($\overline{ENX2} = GND$)

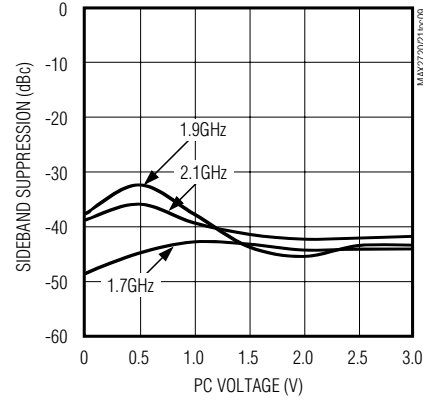

MODULATOR OUTPUT POWER vs. PC VOLTAGE ($\overline{ENX2} = V_{CC}$)

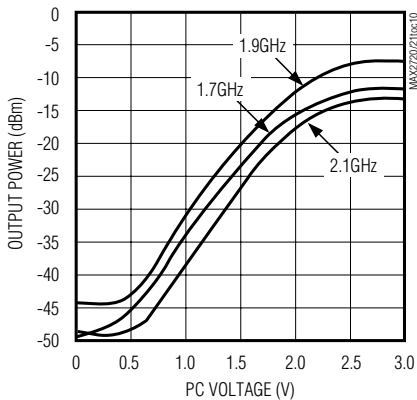

MODULATOR CARRIER SUPPRESSION vs. PC VOLTAGE ($\overline{ENX2} = V_{CC}$)

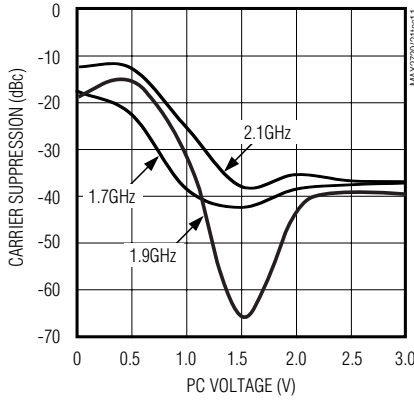

MODULATOR SIDEBAND SUPPRESSION vs. PC VOLTAGE ($\overline{ENX2} = V_{CC}$)

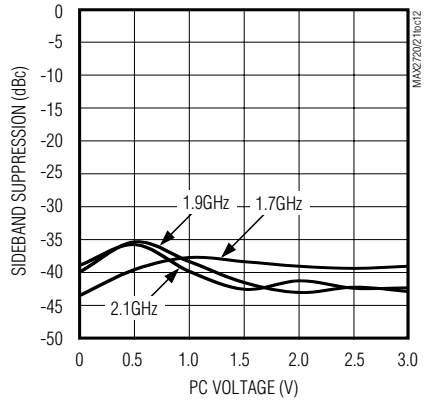

1.7GHz to 2.5GHz, Direct I/Q Modulator with VGA and PA Driver

Typical Operating Characteristics (continued)

(MAX2720/MAX2721 EV Kit, $V_{CC} = +3.0V$, $\overline{SHDN} = V_{CC}$, $\overline{ENX2} = GND$, $V_{PC} = 2.5V$, input I/Q signals driven in quadrature, from a $1k\Omega$ source impedance, single-ended, $f_{I+} = f_{Q+} = 500kHz$, $V_{I+} = V_{Q+} = 200mV_{p-p}$, $P_{LO} = -13dBm$, $f_{LO} = 950MHz$ (MAX2720), $f_{LO} = 1157.5MHz$ (MAX2721), $P_{DRIN} = -12dBm$, $f_{DRIN} = 1900MHz$ (MAX2720), $f_{DRIN} = 2315MHz$ (MAX2721), MODOUT and DROUT ports are matched to a 50Ω load, $T_A = +25^\circ C$, unless otherwise noted.) (Note 1)

MAX2720/MAX2721

MAX2720

MODULATOR OUTPUT POWER vs. PC VOLTAGE ($\overline{ENX2} = GND$)

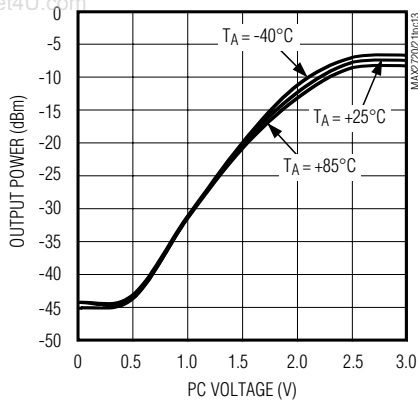

MODULATOR CARRIER SUPPRESSION vs. PC VOLTAGE ($\overline{ENX2} = GND$)

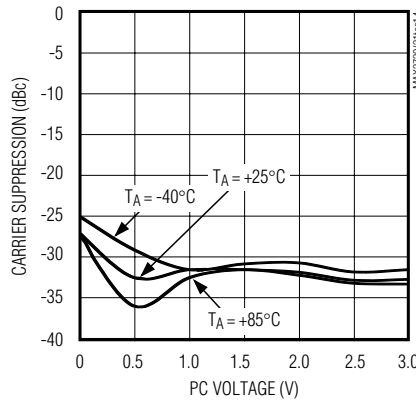

MODULATOR SIDEBAND SUPPRESSION vs. PC VOLTAGE ($\overline{ENX2} = GND$)

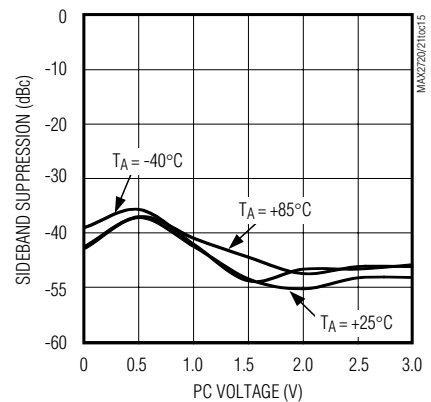

MODULATOR OUTPUT POWER vs. PC VOLTAGE ($\overline{ENX2} = V_{CC}$)

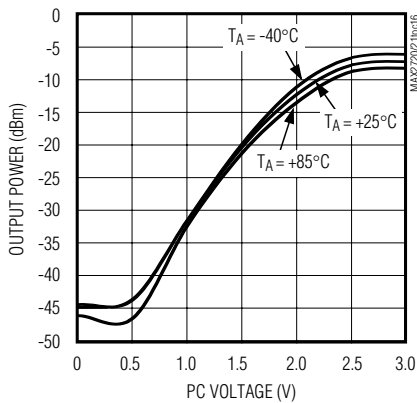

MODULATOR CARRIER SUPPRESSION vs. PC VOLTAGE ($\overline{ENX2} = V_{CC}$)

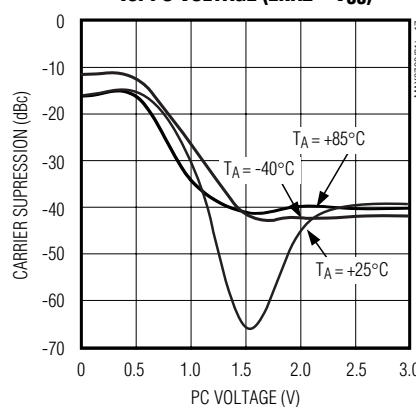

MODULATOR SIDEBAND SUPPRESSION vs. PC VOLTAGE ($\overline{ENX2} = V_{CC}$)

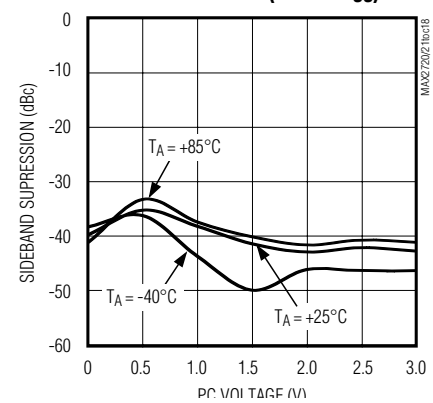

1.7GHz to 2.5GHz, Direct I/Q Modulator with VGA and PA Driver

Typical Operating Characteristics (continued)

(MAX2720/MAX2721 EV Kit, $V_{CC} = +3.0V$, $\overline{SHDN} = V_{CC}$, $\overline{ENX2} = GND$, $V_{PC} = 2.5V$, input I/Q signals driven in quadrature, from a $1k\Omega$ source impedance, single-ended, $f_{I+} = f_{Q+} = 500kHz$, $V_{I+} = V_{Q+} = 200mVp-p$, $P_{LO} = -13dBm$, $f_{LO} = 950MHz$ (MAX2720), $f_{LO} = 1157.5MHz$ (MAX2721), $P_{DRIN} = -12dBm$, $f_{DRIN} = 1900MHz$ (MAX2720), $f_{DRIN} = 2315MHz$ (MAX2721), MODOUT and DROUT ports are matched to a 50Ω load, $T_A = +25^\circ C$, unless otherwise noted.) (Note 1)

MAX2720

MODULATOR OUTPUT POWER vs. INPUT LEVEL ($T_A = -40^\circ C$)

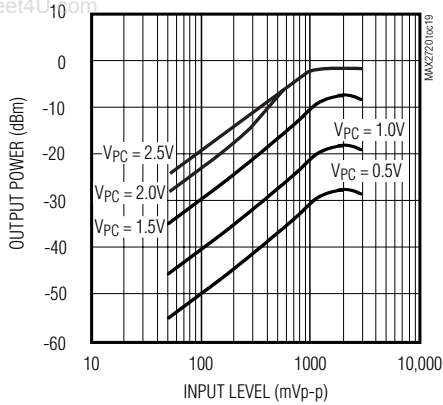

MODULATOR OUTPUT POWER vs. INPUT LEVEL ($T_A = +25^\circ C$)

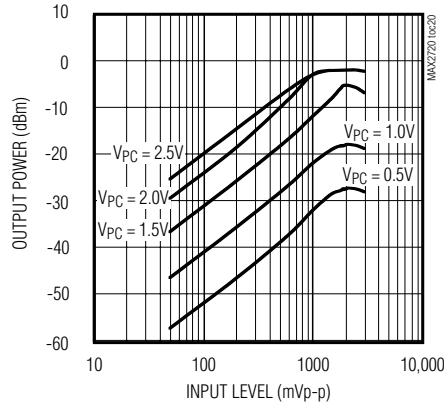

MODULATOR OUTPUT POWER vs. INPUT LEVEL ($T_A = +85^\circ C$)

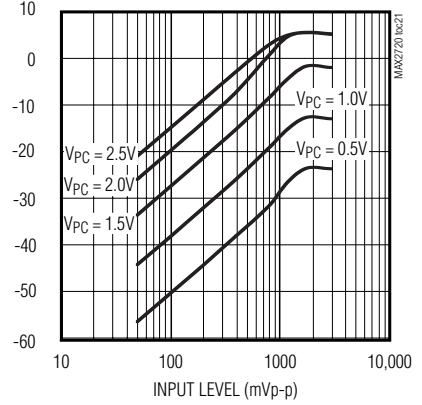

MODULATOR OUTPUT IP3 vs. PC VOLTAGE

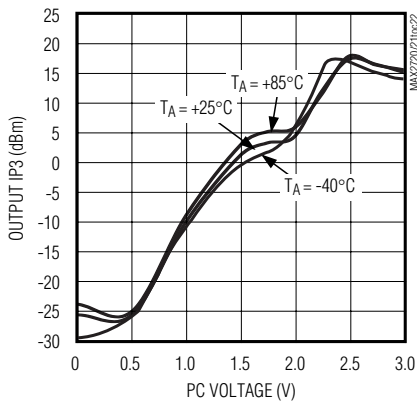

LO PORT VSWR vs. LO FREQUENCY ($\overline{ENX2} = GND$)

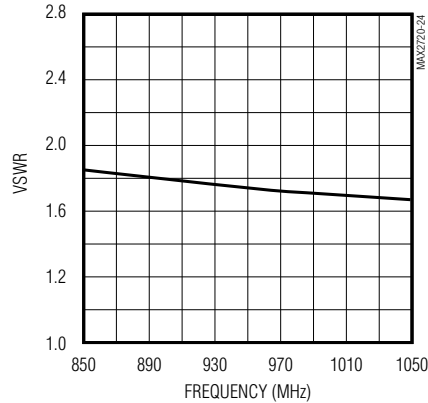

LO PORT VSWR vs. LO FREQUENCY ($\overline{ENX2} = V_{CC}$)

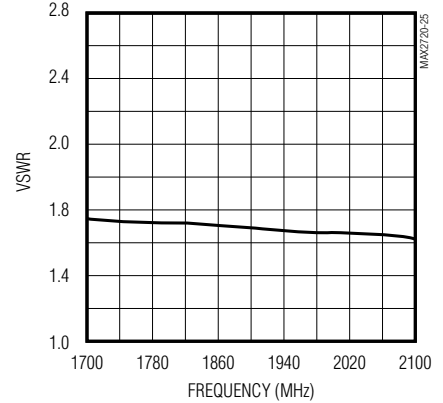

1.7GHz to 2.5GHz, Direct I/Q Modulator with VGA and PA Driver

Typical Operating Characteristics (continued)

(MAX2720/MAX2721 EV Kit, $V_{CC} = +3.0V$, $\overline{SHDN} = V_{CC}$, $\overline{ENX2} = GND$, $V_{PC} = 2.5V$, input I/Q signals driven in quadrature, from a $1k\Omega$ source impedance, single-ended, $f_{I+} = f_{Q+} = 500kHz$, $V_{I+} = V_{Q+} = 200mVp-p$, $P_{LO} = -13dBm$, $f_{LO} = 950MHz$ (MAX2720), $f_{LO} = 1157.5MHz$ (MAX2721), $P_{DRIN} = -12dBm$, $f_{DRIN} = 1900MHz$ (MAX2720), $f_{DRIN} = 2315MHz$ (MAX2721), MODOUT and DROUT ports are matched to a 50Ω load, $T_A = +25^\circ C$, unless otherwise noted.) (Note 1)

MAX2720

PA DRIVER GAIN vs. SUPPLY VOLTAGE

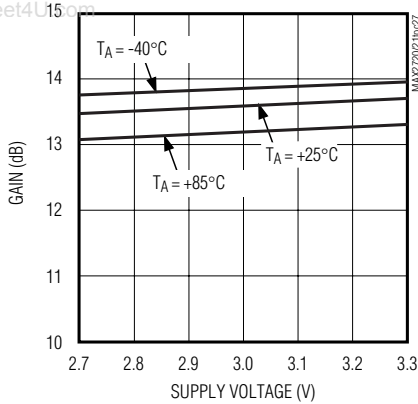

PA DRIVER OUTPUT IP3 vs. SUPPLY VOLTAGE

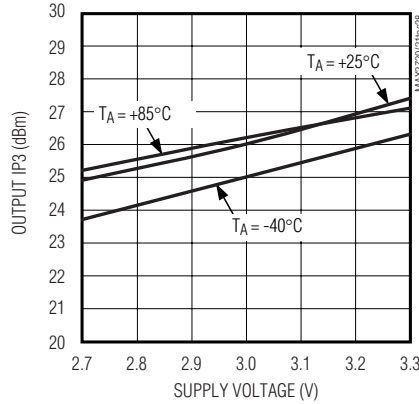

PA DRIVER OUTPUT P1dB vs. SUPPLY VOLTAGE

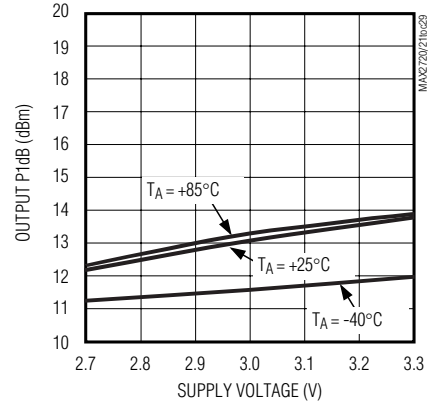

PA DRIVER GAIN vs. RF FREQUENCY

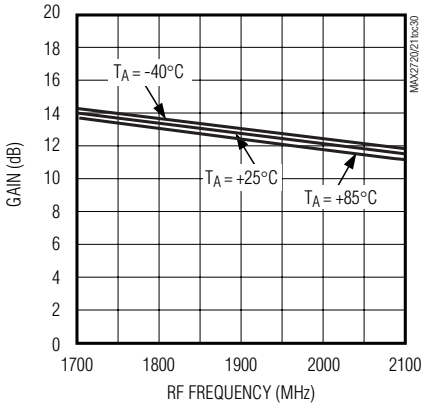

PA DRIVER OUTPUT IP3 vs. FREQUENCY

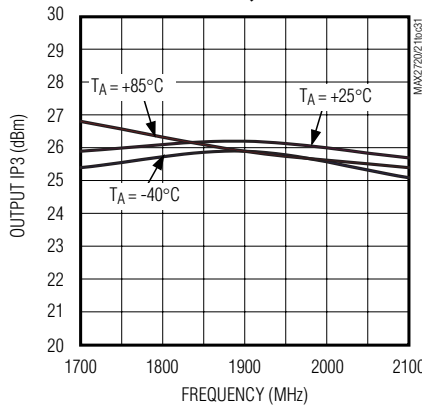

PA DRIVER OUTPUT P1dB COMPRESSION POINT vs. FREQUENCY

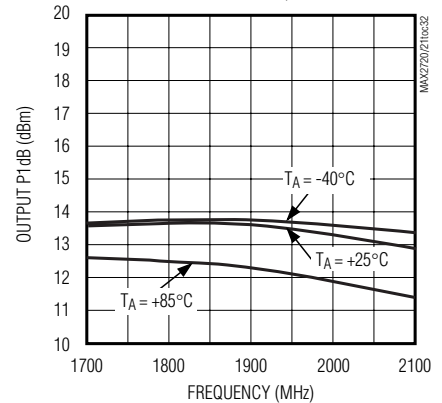

MAX2720/MAX2721

1.7GHz to 2.5GHz, Direct I/Q Modulator with VGA and PA Driver

Typical Operating Characteristics (continued)

(MAX2720/MAX2721 EV Kit, $V_{CC} = +3.0V$, $\overline{SHDN} = V_{CC}$, $\overline{ENX2} = GND$, $V_{PC} = 2.5V$, input I/Q signals driven in quadrature, from a $1k\Omega$ source impedance, single-ended, $f_{I+} = f_{Q+} = 500kHz$, $V_{I+} = V_{Q+} = 200mVp-p$, $P_{LO} = -13dBm$, $f_{LO} = 950MHz$ (MAX2720), $f_{LO} = 1157.5MHz$ (MAX2721), $P_{DRIN} = -12dBm$, $f_{DRIN} = 1900MHz$ (MAX2720), $f_{DRIN} = 2315MHz$ (MAX2721), MODOUT and DROUT ports are matched to a 50Ω load, $T_A = +25^\circ C$, unless otherwise noted.) (Note 1)

MAX2720

PA DRIVER NOISE FIGURE vs. FREQUENCY

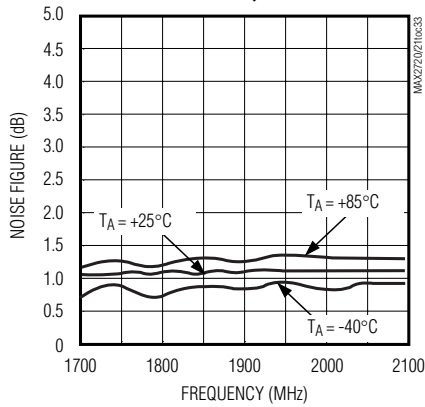

PA DRIVER OUTPUT POWER vs. INPUT POWER

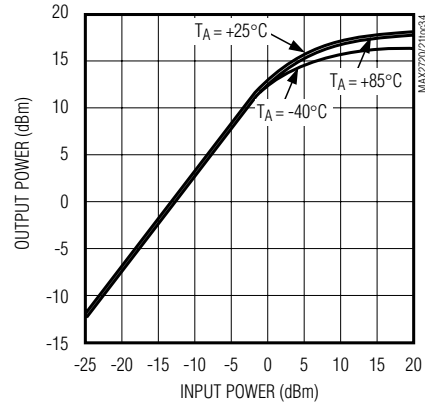

1.7GHz to 2.5GHz, Direct I/Q Modulator with VGA and PA Driver

Typical Operating Characteristics (continued)

(MAX2720/MAX2721 EV Kit, $V_{CC} = +3.0V$, $\overline{SHDN} = V_{CC}$, $\overline{ENX2} = GND$, $V_{PC} = 2.5V$, input I/Q signals driven in quadrature, from a $1k\Omega$ source impedance, single-ended, $f_{I+} = f_{Q+} = 500kHz$, $V_{I+} = V_{Q+} = 200mV_{p-p}$, $P_{LO} = -13dBm$, $f_{LO} = 950MHz$ (MAX2720), $f_{LO} = 1157.5MHz$ (MAX2721), $P_{DRIN} = -12dBm$, $f_{DRIN} = 1900MHz$ (MAX2720), $f_{DRIN} = 2315MHz$ (MAX2721), MODOUT and DROUT ports are matched to a 50Ω load, $T_A = +25^\circ C$, unless otherwise noted.) (Note 1)

MAX2721

SUPPLY CURRENT vs. SUPPLY VOLTAGE WITH PA DRIVER ENABLED

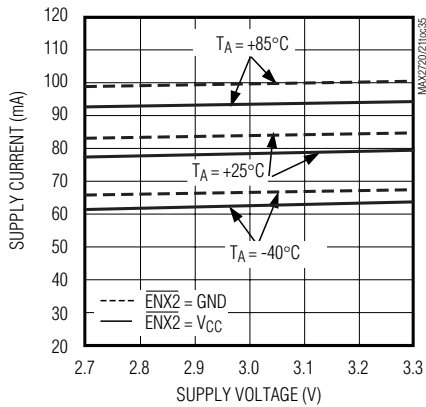

SUPPLY CURRENT vs. SUPPLY VOLTAGE WITH PA DRIVER DISABLED

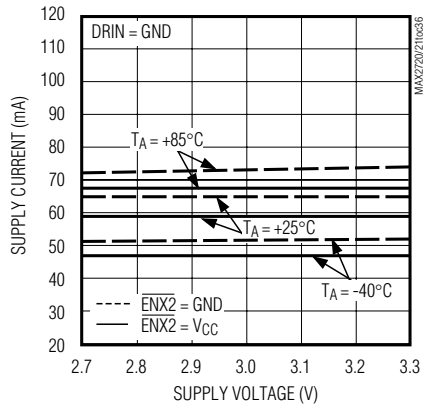

MODULATOR OUTPUT POWER vs. RF FREQUENCY

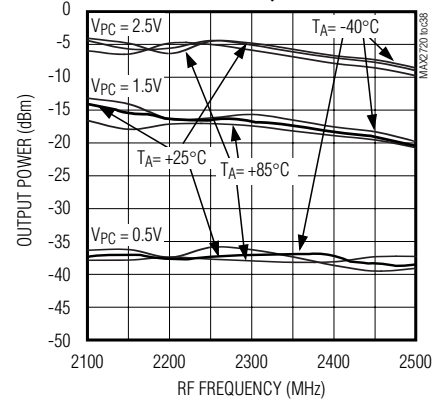

MODULATOR PERFORMANCE vs. LO POWER (ENX2 = GND)

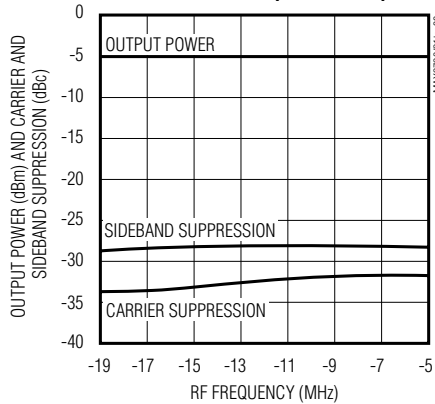

MODULATOR PERFORMANCE vs. LO POWER (ENX2 = VCC)

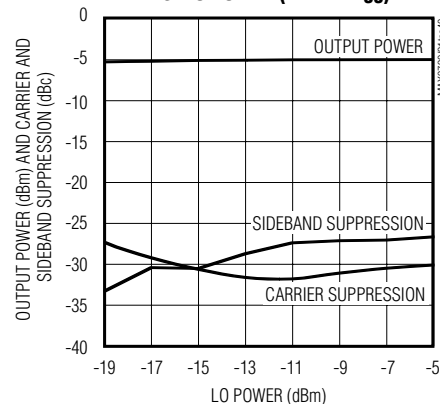

MAX2720/MAX2721

1.7GHz to 2.5GHz, Direct I/Q Modulator with VGA and PA Driver

Typical Operating Characteristics (continued)

(MAX2720/MAX2721 EV Kit, $V_{CC} = +3.0V$, $\overline{SHDN} = V_{CC}$, $\overline{ENX2} = GND$, $V_{PC} = 2.5V$, input I/Q signals driven in quadrature, from a $1k\Omega$ source impedance, single-ended, $f_{I+} = f_{Q+} = 500kHz$, $V_{I+} = V_{Q+} = 200mV_{p-p}$, $P_{LO} = -13dBm$, $f_{LO} = 950MHz$ (MAX2720), $f_{LO} = 1157.5MHz$ (MAX2721), $P_{DRIN} = -12dBm$, $f_{DRIN} = 1900MHz$ (MAX2720), $f_{DRIN} = 2315MHz$ (MAX2721), MODOUT and DROUT ports are matched to a 50Ω load, $T_A = +25^\circ C$, unless otherwise noted.) (Note 1)

MAX2721

MODULATOR OUTPUT POWER vs. PC VOLTAGE (ENX2 = GND)

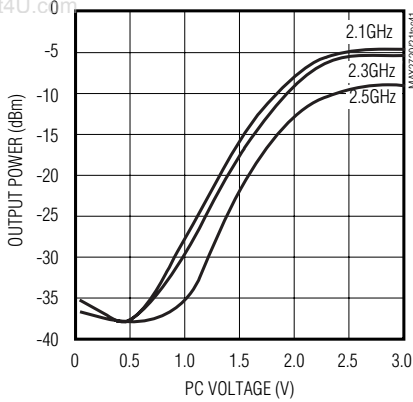

CARRIER SUPPRESSION vs. PC VOLTAGE (ENX2 = GND)

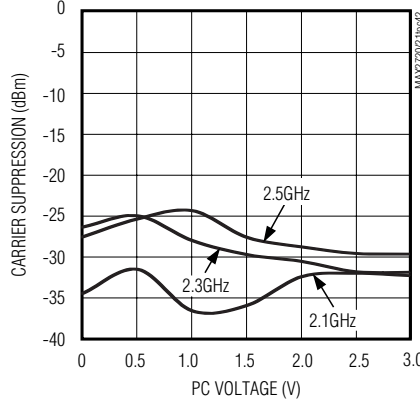

SIDEBAND SUPPRESSION vs. PC VOLTAGE (ENX2 = GND)

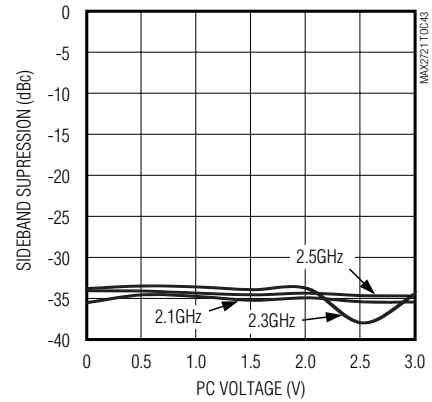

MODULATOR OUTPUT POWER vs. PC VOLTAGE (ENX2 = VCC)

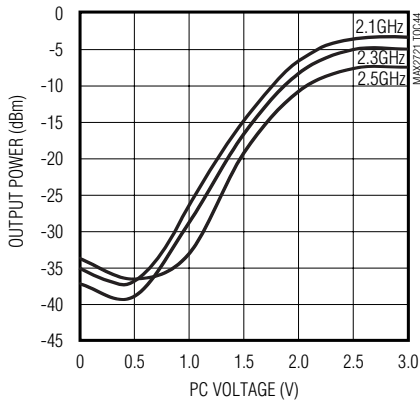

MODULATOR CARRIER SUPPRESSION vs. PC VOLTAGE (ENX2 = VCC)

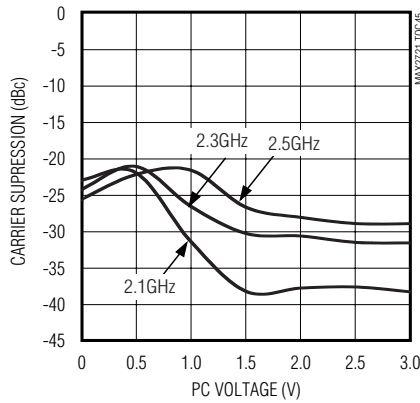

MODULATOR SIDEBAND SUPPRESSION vs. PC VOLTAGE (ENX2 = VCC)

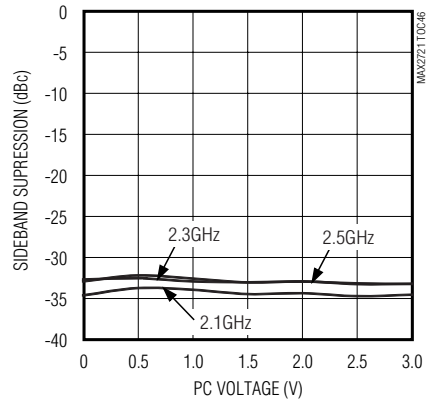

1.7GHz to 2.5GHz, Direct I/Q Modulator with VGA and PA Driver

Typical Operating Characteristics (continued)

(MAX2720/MAX2721 EV Kit, $V_{CC} = +3.0V$, $\overline{SHDN} = V_{CC}$, $\overline{ENX2} = GND$, $V_{PC} = 2.5V$, input I/Q signals driven in quadrature, from a $1k\Omega$ source impedance, single-ended, $f_{I+} = f_{Q+} = 500kHz$, $V_{I+} = V_{Q+} = 200mV_{p-p}$, $P_{LO} = -13dBm$, $f_{LO} = 950MHz$ (MAX2720), $f_{LO} = 1157.5MHz$ (MAX2721), $P_{DRIN} = -12dBm$, $f_{DRIN} = 1900MHz$ (MAX2720), $f_{DRIN} = 2315MHz$ (MAX2721), MODOUT and DROUT ports are matched to a 50Ω load, $T_A = +25^\circ C$, unless otherwise noted.) (Note 1)

MAX2721

MODULATOR OUTPUT POWER vs. PC VOLTAGE ($\overline{ENX2} = GND$)

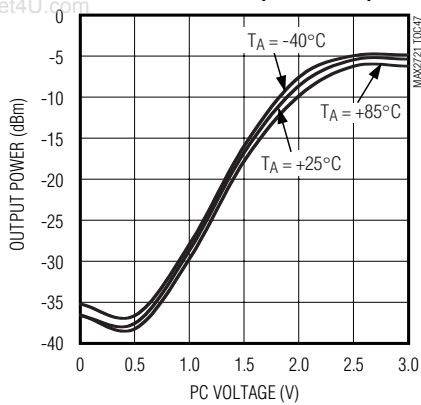

MODULATOR CARRIER SUPPRESSION vs. PC VOLTAGE ($\overline{ENX2} = GND$)

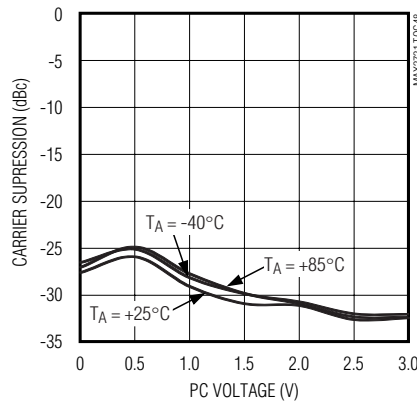

MODULATOR SIDEBAND SUPPRESSION vs. PC VOLTAGE ($\overline{ENX2} = GND$)

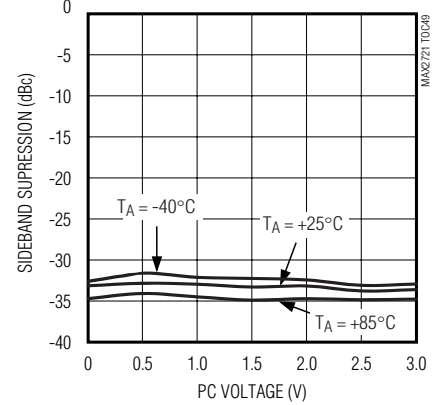

MODULATOR OUTPUT POWER vs. PC VOLTAGE ($\overline{ENX2} = V_{CC}$)

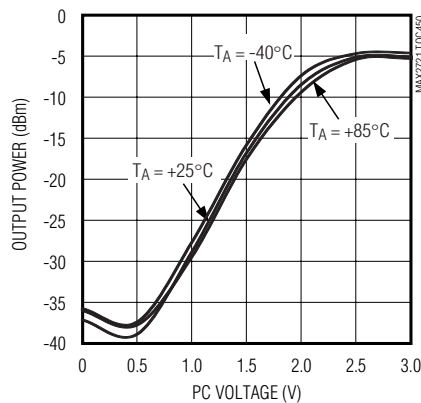

MODULATOR CARRIER SUPPRESSION vs. PC VOLTAGE ($\overline{ENX2} = V_{CC}$)

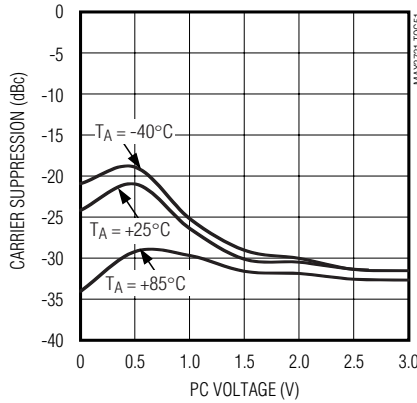

MODULATOR SIDEBAND SUPPRESSION vs. PC VOLTAGE ($\overline{ENX2} = V_{CC}$)

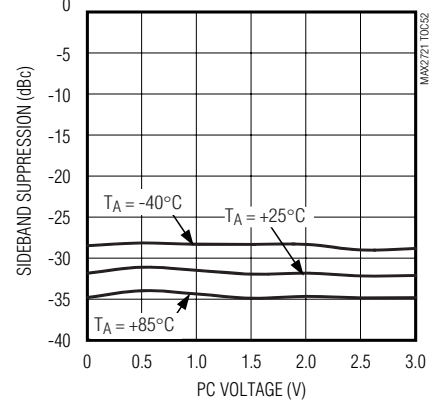

MAX2720/MAX2721

1.7GHz to 2.5GHz, Direct I/Q Modulator with VGA and PA Driver

Typical Operating Characteristics (continued)

(MAX2720/MAX2721 EV Kit, $V_{CC} = +3.0V$, $\overline{SHDN} = V_{CC}$, $\overline{ENX2} = GND$, $V_{PC} = 2.5V$, input I/Q signals driven in quadrature, from a $1k\Omega$ source impedance, single-ended, $f_{I+} = f_{Q+} = 500kHz$, $V_{I+} = V_{Q+} = 200mV_{p-p}$, $P_{LO} = -13dBm$, $f_{LO} = 950MHz$ (MAX2720), $f_{LO} = 1157.5MHz$ (MAX2721), $P_{DRIN} = -12dBm$, $f_{DRIN} = 1900MHz$ (MAX2720), $f_{DRIN} = 2315MHz$ (MAX2721), MODOUT and DROUT ports are matched to a 50Ω load, $T_A = +25^\circ C$, unless otherwise noted.) (Note 1)

MAX2721

MODULATOR OUTPUT POWER vs. INPUT LEVEL ($T_A = -40^\circ C$)

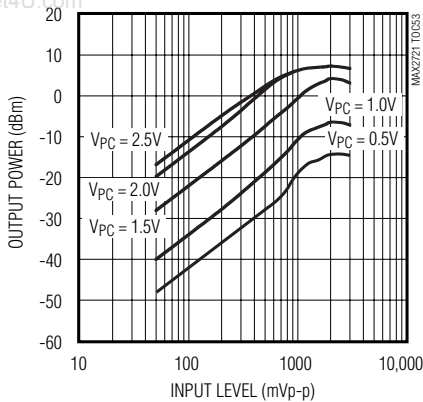

MODULATOR OUTPUT POWER vs. INPUT LEVEL ($T_A = +25^\circ C$)

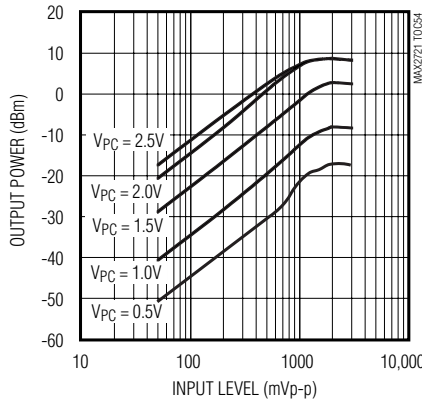

MODULATOR OUTPUT POWER vs. INPUT LEVEL ($T_A = +85^\circ C$)

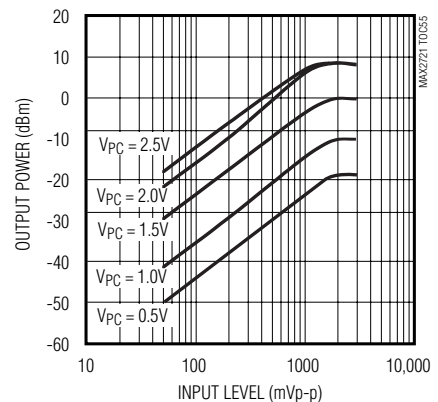

MODULATOR OUTPUT IP3 vs. PC VOLTAGE

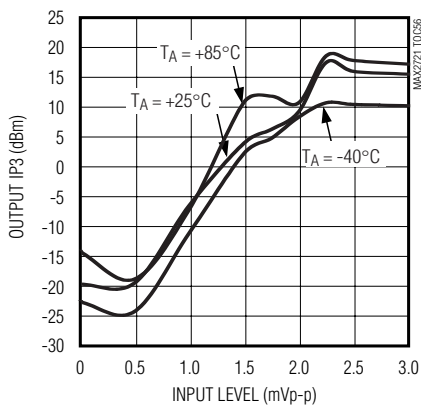

MODULATOR OUTPUT P1dB COMPRESSION POINT vs. PC VOLTAGE

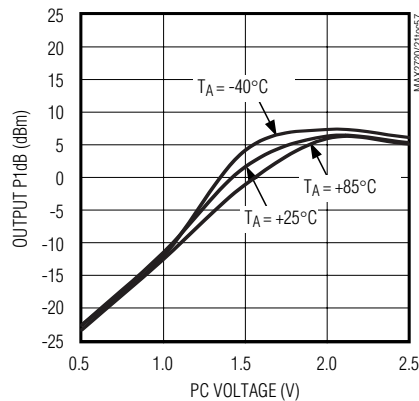

LO PORT VSWR vs. LO FREQUENCY ($ENX2 = V_{CC}$)

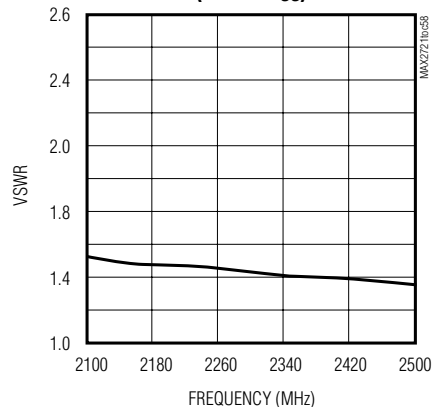

1.7GHz to 2.5GHz, Direct I/Q Modulator with VGA and PA Driver

Typical Operating Characteristics (continued)

(MAX2720/MAX2721 EV Kit, $V_{CC} = +3.0V$, $\overline{SHDN} = V_{CC}$, $\overline{ENX2} = GND$, $V_{PC} = 2.5V$, input I/Q signals driven in quadrature, from a $1k\Omega$ source impedance, single-ended, $f_{I+} = f_{Q+} = 500kHz$, $V_{I+} = V_{Q+} = 200mV_{p-p}$, $P_{LO} = -13dBm$, $f_{LO} = 950MHz$ (MAX2720), $f_{LO} = 1157.5MHz$ (MAX2721), $P_{DRIN} = -12dBm$, $f_{DRIN} = 1900MHz$ (MAX2720), $f_{DRIN} = 2315MHz$ (MAX2721), MODOUT and DROUT ports are matched to a 50Ω load, $T_A = +25^\circ C$, unless otherwise noted.) (Note 1)

MAX2721

LO PORT VSWR vs. FREQUENCY
(ENX2 = GND)

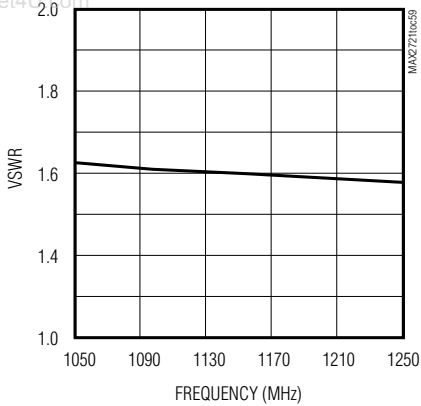

PA DRIVER GAIN vs. SUPPLY VOLTAGE

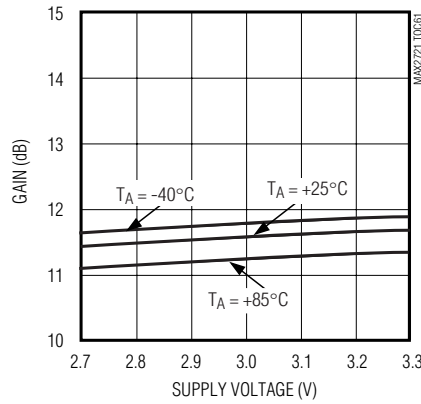

PA DRIVER OUTPUT IP3 vs. SUPPLY VOLTAGE

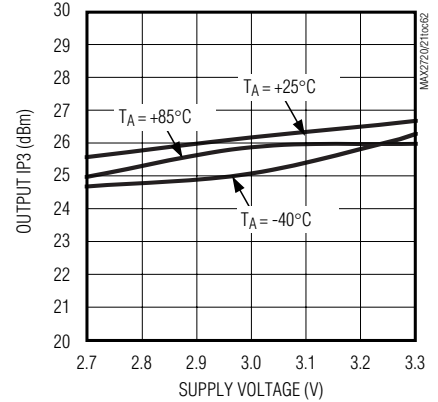

PA DRIVER OUTPUT P1dB vs. SUPPLY VOLTAGE

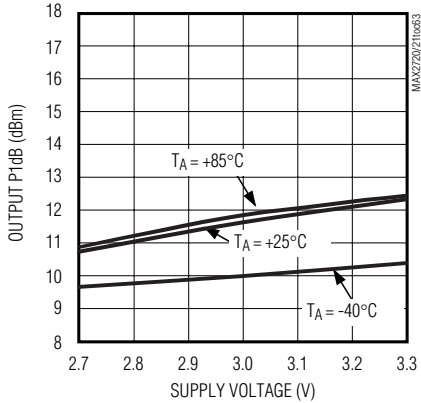

PA DRIVER GAIN vs. RF FREQUENCY

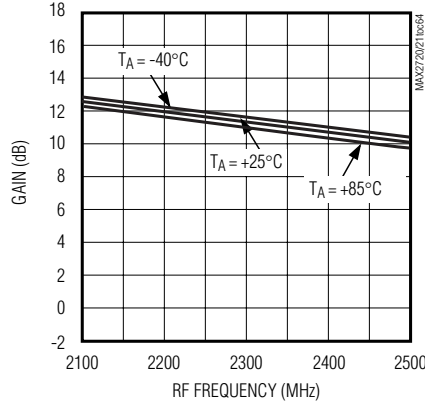

PA DRIVER OUTPUT IP3 vs. FREQUENCY

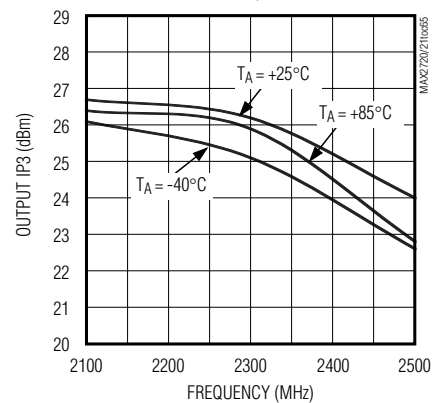

MAX2720/MAX2721

1.7GHz to 2.5GHz, Direct I/Q Modulator with VGA and PA Driver

Typical Operating Characteristics (continued)

(MAX2720/MAX2721 EV Kit, $V_{CC} = +3.0V$, $\overline{SHDN} = V_{CC}$, $\overline{ENX2} = GND$, $V_{PC} = 2.5V$, input I/Q signals driven in quadrature, from a $1k\Omega$ source impedance, single-ended, $f_{I+} = f_{Q+} = 500kHz$, $V_{I+} = V_{Q+} = 200mVp-p$, $P_{LO} = -13dBm$, $f_{LO} = 950MHz$ (MAX2720), $f_{LO} = 1157.5MHz$ (MAX2721), $P_{DRIN} = -12dBm$, $f_{DRIN} = 1900MHz$ (MAX2720), $f_{DRIN} = 2315MHz$ (MAX2721), MODOUT and DROUT ports are matched to a 50Ω load, $T_A = +25^\circ C$, unless otherwise noted.) (Note 1)

MAX2721

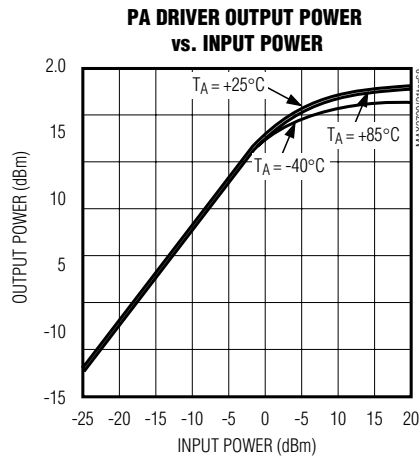
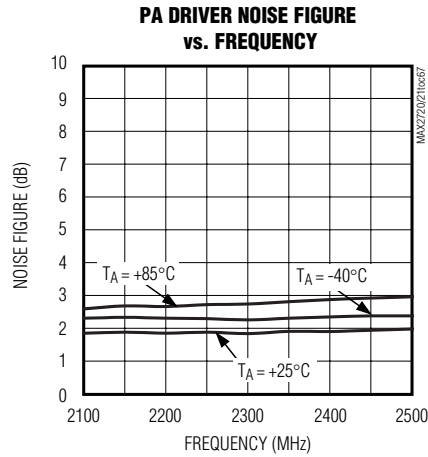
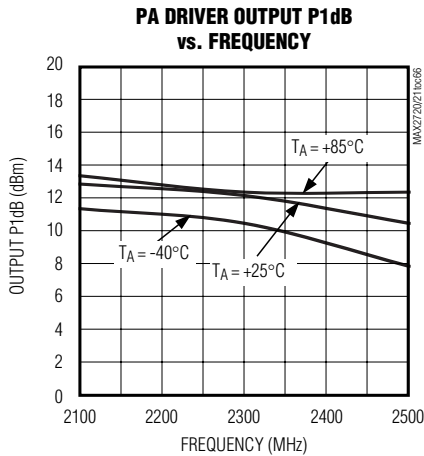

1.7GHz to 2.5GHz, Direct I/Q Modulator with VGA and PA Driver

MAX2720/MAX2721

Pin Description

PIN	NAME	FUNCTION
1, 5, 10, 19, EP	GND	Ground. Connect to ground plane with lowest inductance path. Solder exposed paddle evenly to the board ground plane.
2	DROUT	PA Driver Open-Collector Output Port. Requires an external matching network and a pull-up inductor to V_{CC} for proper biasing. See <i>Typical Application Circuit</i> for recommended component values.
3	$\overline{\text{SHDN}}$	Shutdown Control Input. Drive with a logic-level high to enable the device. Drive with a logic-level low to disable the device. Bypass with a 1000pF capacitor to ground, as close to the pin as possible to minimize the amount of external noise coupled onto the control line.
4, 6, 9, 12, 15	V_{CC}	Supply Voltage Input. Bypass to ground with the specified capacitor as close to the pin as possible. (See <i>Typical Application Circuit</i> .)
7, 8	I-, I+	In-Phase Differential Input Ports. Requires DC-blocking capacitors. See <i>Typical Application Circuit</i> for recommended component values.
11	LO	Local Oscillator input. Internally matched to 50Ω over the operating frequency band. Requires a DC-blocking capacitor. See <i>Typical Application Circuit</i> for recommended component values.
13, 14	Q+, Q-	Quadrature Differential Input Ports. Requires DC-blocking capacitors. See <i>Typical Application Circuit</i> for recommended component values.
16	$\overline{\text{ENX2}}$	Logic-Level Enable Input for LO Doubler. Drive with a logic-level low to enable the doubler, allowing the external LO to run at half-frequency, $f_{LO} = f_{OUT} / 2$. Drive with a logic-level high to disable the doubler, and allow the external LO to run at full-frequency, $f_{LO} = f_{OUT}$. Bypass with a 1000pF capacitor to ground as close to the pin as possible to minimize noise coupled into the control line.
17	MODOUT	Modulator Open-Collector Output Port. Requires an external matching network and a pull-up inductor to V_{CC} for proper biasing. See <i>Typical Application Circuit</i> for recommended component values.
18	PC	Modulator Power Control Input. Apply a voltage between 0.5V to 2.5V to vary the output power of the I/Q modulator over a 30dB range. Bypass with a 1000pF capacitor to ground as close to the pin as possible to minimize noise on the control line.
20	DRIN	PA Driver Amplifier Input Port. Requires an external matching network and a DC-blocking capacitor that can be part of the matching network. See <i>Typical Application Circuit</i> for recommended component values. Connect to ground to disable the PA Driver and reduce supply current.

Detailed Description

The MAX2720/MAX2721 upconvert in-phase (I) and quadrature (Q) baseband signals directly to RF frequencies of 1700MHz to 2100MHz (MAX2720) or 2100MHz to 2500MHz (MAX2721). They are designed for wideband-CDMA and WLL systems where direct I/Q modulation of the RF carrier reduces system cost, component count, and board space compared to dual-conversion architectures.

Internally, the MAX2720/MAX2721 include an I/Q modulator, a variable gain amplifier (VGA), and a PA driver. Separate modulator output and PA driver input ports allow insertion of a bandpass filter between the modulator and PA driver for increased noise rejection. Disable the stand-alone PA driver to reduce current consumption. A low-power shutdown mode further reduces current consumption to less than $0.1\mu\text{A}$. Additionally, a logic-level control disables or enables an internal frequency doubler that allows the external LO to run at full or half frequency.

1.7GHz to 2.5GHz, Direct I/Q Modulator with VGA and PA Driver

I/Q Modulator

The MAX2720/MAX2721 modulator is composed of a pair of matched double-balanced mixers, an active LO quadrature generator, and a summing amplifier. The pair of mixers accept differential I/Q baseband signals that directly modulate the internal 0° and 90° LO signals applied to the I/Q mixers. An external LO source drives an internal LO quadrature generator that shifts the phase of the LO signal applied to the Q mixer by 90° relative to the LO signal applied to the I channel mixer. The modulated output of the I/Q mixers is summed together, and the undesired sideband is suppressed.

The I+, I-, Q+, and Q- input ports feature high-linearity buffer amplifiers with a -1dB bandwidth of 20MHz and a -3dB bandwidth of 38MHz (1kΩ I/Q source impedance), and accept differential input voltages up to 630mVp-p. Input bandwidth can be extended to beyond 100MHz by lowering the I/Q source impedance. The ports are internally biased and therefore require DC-blocking capacitors. For single-ended operation, bypass the I- and Q- ports with a capacitor to ground equal in value to the DC-blocking capacitors used on the I+ and Q+ ports. See the *Typical Application Circuit* for recommended component values.

Variable Gain Amplifier (VGA)

A VGA follows the summing amplifier of the I/Q modulator. Apply a voltage between 0.5V and 2.5V to PC to vary the output power of the modulator over a 32dB span.

The open-collector MODOUT output requires a pull-up inductor to VCC for proper biasing, an external matching network for optimum power transfer, and a DC-blocking capacitor. Since the MAX2720/MAX2721 are optimized for different frequency ranges, they require different output matching networks. See the MAX2720 and

MAX2721 *Typical Application Circuit* for recommended component values. See Table 1 for matching to other frequencies.

LO Buffer and LO Frequency Doubler

The MAX2720/MAX2721 feature an internal LO frequency doubler that allows the external LO source to run at full or half frequency (Table 2). Operating the LO at half frequency reduces injection-pulling of the voltage-controlled oscillator (VCO) from the PA, and reduces the complexity of designing a high-frequency VCO. An internal two-pole bandpass filter is integrated before the LO phase-shift network to help reduce LO harmonic content and spurious mixing.

To enable the LO frequency doubler, drive $\overline{\text{ENX2}}$ to a logic-level low and operate the external LO source at half the RF carrier frequency. To disable the LO frequency doubler, drive $\overline{\text{ENX2}}$ to a logic-level high and run the external LO source at the RF carrier frequency. See Table 2 for LO input frequency ranges.

The LO port is a single-ended input that achieves a VSWR of better than 2:1 over the specified LO input frequency range. Since the port is internally terminated with 50Ω, it requires a DC-blocking capacitor. See the *Typical Applications Circuits* for recommended component values. For optimum performance, drive the LO port with an input power of -16dBm to -10dBm. Driving the LO port with lower input power levels may affect quadrature performance, while higher input powers may increase LO leakage.

PA Driver Amplifier

The PA driver provides a gain of 13.5dB for the MAX2720 and 11.5dB for the MAX2721. The DRIN input port requires an external matching network and a

Table 1. VGA MODOUT S22 Parameters (VCC = 3.0V, VPC = 2.5V, TA = +25°C)

MAX2720			MAX2721		
FREQUENCY (MHz)	S22 MAG	S22 PHASE (degrees)	FREQUENCY (MHz)	S22 MAG	S22 PHASE (degrees)
1700	0.914	-66.6	2100	0.861	-86.5
1750	0.909	-68.9	2150	0.861	-91.3
1800	0.896	-71.0	2200	0.832	-93.8
1850	0.884	-73.0	2250	0.811	-94.4
1900	0.871	-74.6	2300	0.807	-94.7
1950	0.868	75.4	2350	0.834	-94.8
2000	0.878	-77.1	2400	0.866	-97.1
2050	0.892	-79.6	2450	0.891	-100.5
2100	0.897	82.5	2500	0.905	-104.5

1.7GHz to 2.5GHz, Direct I/Q Modulator with VGA and PA Driver

MAX2720/MAX2721

Table 2. LO Input Frequency Range

ENX2 LOGIC LEVEL	LO INPUT FREQUENCY RANGE (MHz)	
	MAX2720	MAX2721
Low	850 to 1050	1050 to 1250
High	1700 to 2100	2100 to 2500

DC-blocking capacitor that can be part of the matching network. The DROUT open-collector output port requires an external matching network and a pull-up inductor to VCC for proper biasing. The pull-up inductor is incorporated as part of the matching network. See the MAX2720 and MAX2721 *Typical Application Circuit* for recommended component values. Refer to Table 3 for matching to other frequencies.

If the additional gain of the PA driver is not required, disable the PA driver to reduce current consumption. To disable the PA driver, short pin 20 (DRIN) to ground and leave pin 2 unconnected.

Shutdown

Apply a logic-level high to the SHDN pin to enable the MAX2720/MAX2721. Apply a logic-level low voltage to disable the device and reduce supply current to less than 0.1μA.

Applications Information

Layout Considerations

A properly designed PC board is an essential part of any RF circuit. A ground plane is essential. Keep RF signal lines as short as possible to reduce losses, radiation, and inductance. Use separate, low-inductance vias to the ground plane for each pin. For best performance, solder the exposed pad on the bottom of the device package evenly to the board ground plane. Remove the ground plane under the external VCO and lowpass filters to reduce the effects of parasitic capaci-

tance. In direct I/Q modulator applications, radiated power from the PA can couple into the VCO tank. To reduce PA injection-pulling, the external VCO should be housed in a separate shielded compartment if possible.

Power-Supply, Logic, and PC Input Bypassing

Proper voltage supply bypassing is essential for high-frequency circuit stability. With the exception of pin 6, bypass all VCC pins with a 470pF capacitor as close to the VCC pins as possible. The decoupling capacitor for pin 6 also serves as part of an on-chip matching network, so it should be chosen to resonate out series inductance on the board. Some empirical adjustment may yield increased output power. See the MAX2720/MAX2721 *Typical Application Circuit* for suggested values.

Bypass the ENX2, SHDN, and PC inputs with a 1000pF capacitor to ground to minimize noise injected into the device. Use a series resistor (10kΩ typ) to further reduce coupling of high-frequency signals into the device.

Voltage supply layout is also critical to achieve optimum performance. The IC has several RF processing stages that use the various VCC pins, and while they have on-chip decoupling, off-chip interaction between them may degrade gain, linearity, carrier suppression, and output power control range. The supplies associated with pins 2, 6, 15 (MAX2721 only), and 17 lie directly in the RF signal path. Pins 4, 12, and 15 carry LO signal currents, so it is important to keep them from interacting with the RF signal path to prevent poor carrier suppression. The VGA generates discarded signal currents on pin 4, which also need to be kept away from the signal path supplies. Because there is a great deal of gain following from the first RF stage, it is also important to prevent coupling from pins 2, 4, 15, and 17 to pin 6; excessive coupling may degrade stability.

1.7GHz to 2.5GHz, Direct I/Q Modulator with VGA and PA Driver

MAX2720/MAX2721

Table 3. PA Driver S-Parameters (VCC = 3.0V, TA = +25°C)

FREQUENCY (MHz)	S11 MAG	S11 PHASE	S21 MAG	S21 PHASE	S12 MAG	S21 PHASE	S22 MAG	S22 PHASE
1700	0.321	151.6	4.708	178.1	0.092	164.7	0.162	-82.4
1750	0.347	152.7	4.588	171.5	0.094	154.2	0.158	-90.3
1800	0.383	152.0	4.389	161.7	0.097	147.2	0.142	-99.5
1850	0.418	149.4	4.370	153.5	0.093	138.2	0.123	-109.2
1900	0.449	145.3	4.160	144.3	0.093	129.7	0.095	-118.4
1950	0.421	140.1	3.946	135.2	0.091	128.7	0.082	-100.8
2000	0.425	142.8	3.801	128.4	0.096	121.2	0.091	-111.0
2050	0.440	142.8	3.690	120.4	0.100	112.8	0.083	-120.3
2100	0.452	142.9	3.567	112.3	0.105	104.9	0.082	-128.8
2150	0.470	141.3	3.492	104.2	0.102	97.2	0.066	-138.0
2200	0.475	139.0	3.360	96.2	0.106	88.0	0.055	-142.7
2250	0.473	136.9	3.268	87.4	0.106	84.2	0.046	-138.9
2300	0.456	135.8	3.176	80.4	0.110	75.9	0.051	-133.9
2350	0.462	135.3	3.087	71.7	0.117	67.9	0.042	-153.1
2400	0.447	132.9	3.013	63.5	0.118	59.7	0.031	-141.0
2450	0.437	132.2	2.929	55.4	0.123	51.6	0.026	-144.9
2500	0.425	130.3	2.848	47.0	0.125	40.9	0.015	-97.8

1.7GHz to 2.5GHz, Direct I/Q Modulator with VGA and PA Driver

Pin Configuration

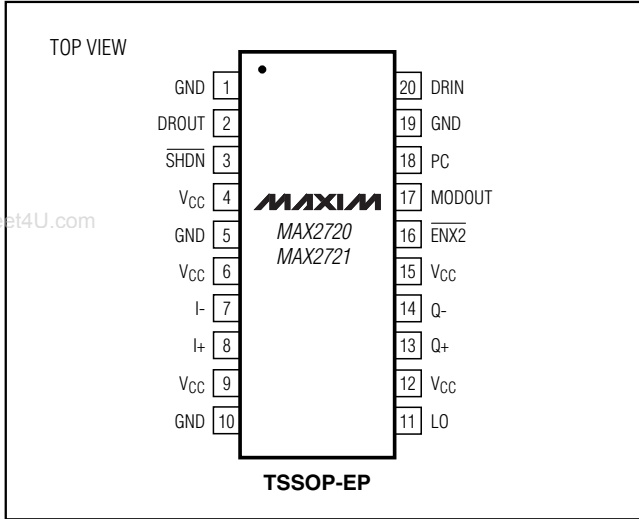

Chip Information

TRANSISTOR COUNT: 1041

1.7GHz to 2.5GHz, Direct I/Q Modulator with VGA and PA Driver

Package Information

MAX2720/MAX2721

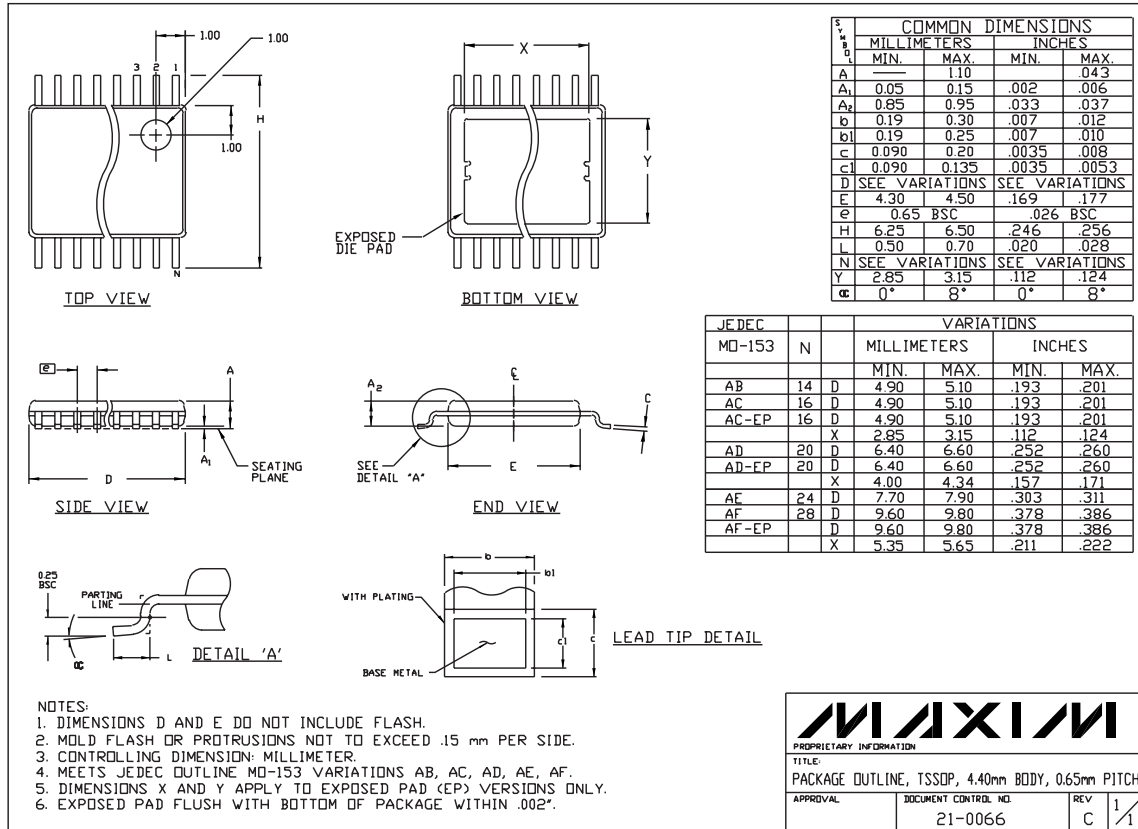

TSSOP-EP

MAXIM

PROPRIETARY INFORMATION

TITLE:
PACKAGE OUTLINE, TSSOP, 4.40mm BODY, 0.65mm PITCH

APPROVAL	DOCUMENT CONTROL NO.	REV
	21-0066	C 1/1

1.7GHz to 2.5GHz, Direct I/Q Modulator with VGA and PA Driver

NOTES

MAX2720/MAX2721

www.DataSheet4U.com

Maxim cannot assume responsibility for use of any circuitry other than circuitry entirely embodied in a Maxim product. No circuit patent licenses are implied. Maxim reserves the right to change the circuitry and specifications without notice at any time.

24 _____ **Maxim Integrated Products, 120 San Gabriel Drive, Sunnyvale, CA 94086 408-737-7600**

© 2000 Maxim Integrated Products

Printed USA

MAXIM is a registered trademark of Maxim Integrated Products.

www.DataSheet4U.com