

# Battery Switch with Four Enable Inputs

## General Description

The MAX14525 features a low  $R_{ON}$  35m $\Omega$  (typ) load switch with four unique enable inputs. The MAX14525 is ideal for disconnecting the lithium-ion (Li+) battery from the loads in portable devices such as cell phones. The MAX14525 operates from a +2.2V to +5.5V supply voltage.

The MAX14525 features an extremely low 0.8 $\mu$ A (typ) quiescent supply current to maximize battery life in portable devices. It is enabled from four possible inputs: external charger connection capable of high voltage up to +28V, travel adapter (TA), on key (ON\_K), factory mode enable (JIG), and switch enable (S\_EN). The S\_EN input is internally ANDed with the switched battery connection (IN).

The MAX14525 is available in a small 8-pin, 2mm x 2mm TDFN package and operates over the -40°C to +85°C extended temperature range.

## Applications

- Cell Phones
- PDAs
- GPS
- UMPC Computers
- Digital Cameras

## Features

- ◆ Low 35m $\Omega$  (typ)  $R_{ON}$  Load Switch
- ◆ Ultra Low, 0.8 $\mu$ A (typ) Supply Current
- ◆ Four Enable Inputs:
  - TA: +28V (max) Capable
  - ON\_K: Accurate +3V Trigger Enable
  - JIG: Factory Mode Enable
  - S\_EN: Logically ANDed with IN
- ◆ Space-Saving 8-Pin, 2mm x 2mm TDFN Package
- ◆ Controlled Turn-On to Limit di/dt Pulses Due to Lead Inductance

## Ordering Information

| PART          | PIN-PACKAGE | TOP MARK |
|---------------|-------------|----------|
| MAX14525ETA+T | 8 TDFN-EP*  | ACQ      |

**Note:** The device is specified over the -40°C to +85°C operating temperature range.  
+Denotes a lead-free/RoHS-compliant package.  
\*EP = Exposed pad.

## Typical Application Circuit

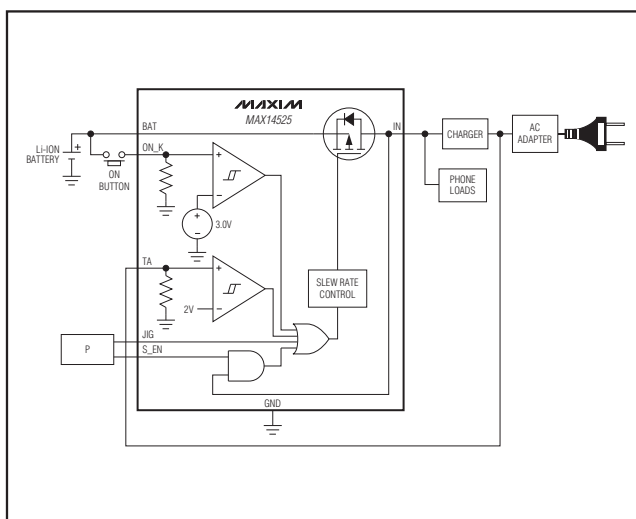

## Pin Configuration

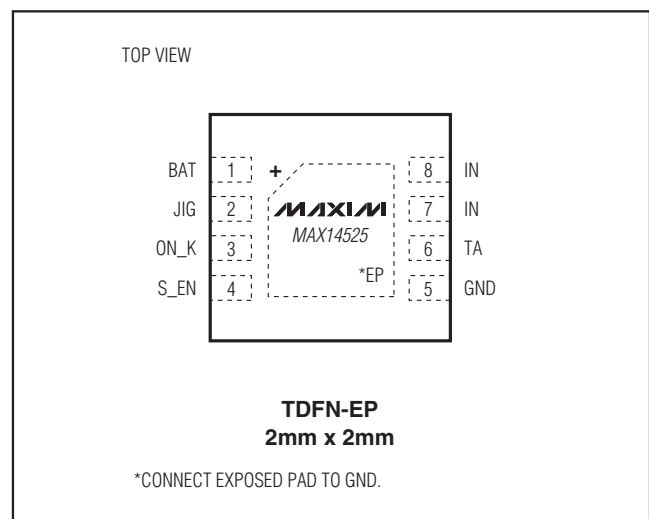

# Battery Switch with Four Enable Inputs

## ABSOLUTE MAXIMUM RATINGS

(All voltages referenced to GND.)

|  |                              |
|--|------------------------------|
| IN, BAT, JIG, S_EN, ON_K .....   | -0.3V to +6.0V               |
| TA .....   | -0.3V to +28V                |
| Continuous Power Dissipation ( $T_A = +70^\circ\text{C}$ )                     |                              |
| 8-Pin TDFN (derate 11.9 mW/ $^\circ\text{C}$ above $+70^\circ\text{C}$ ) ..... | 954 mW                       |
| Junction-to-Case Thermal Resistance<br>( $\theta_{JC}$ ) (Note 1) .....        | 37 $^\circ\text{C}/\text{W}$ |

Junction-to-Ambient Thermal Resistance

|   |   |
|---|---|
| ( $\theta_{JA}$ ) (Note 1) .....        | 84 $^\circ\text{C}/\text{W}$                  |
| Operating Temperature Range .....       | -40 $^\circ\text{C}$ to +85 $^\circ\text{C}$  |
| Junction Temperature .....              | +150 $^\circ\text{C}$                         |
| Storage Temperature Range .....         | -65 $^\circ\text{C}$ to +150 $^\circ\text{C}$ |
| Lead Temperature (soldering, 10s) ..... | +300 $^\circ\text{C}$                         |

**Note 1:** Package thermal resistances were obtained using the method described in JEDEC specification JESD51-7, using a four-layer board. For detailed information on package thermal considerations, refer to [www.maxim-ic.com/thermal-tutorial](http://www.maxim-ic.com/thermal-tutorial).

Stresses beyond those listed under "Absolute Maximum Ratings" may cause permanent damage to the device. These are stress ratings only, and functional operation of the device at these or any other conditions beyond those indicated in the operational sections of the specifications is not implied. Exposure to absolute maximum rating conditions for extended periods may affect device reliability.

## ELECTRICAL CHARACTERISTICS

( $V_{BAT} = +2.2\text{V}$  to  $+5.5\text{V}$ ,  $T_A = -40^\circ\text{C}$  to  $+85^\circ\text{C}$ , unless otherwise noted. Typical values are at  $V_{BAT} = +3.6\text{V}$  and  $T_A = +25^\circ\text{C}$ .) (Note 2)

| PARAMETER   | SYMBOL            | CONDITIONS  | MIN             | TYP | MAX             | UNITS            |
|---|-------------------|---|-----------------|-----|-----------------|------------------|
| <b>DC CHARACTERISTICS</b>                                   |                   |   |                 |     |                 |                  |
| Input Voltage Range   | $V_{BAT}, V_{IN}$ |   | 2.2             |     | 5.5             | V                |
| On-Resistance   | $R_{ON}$          | $I_{LOAD} = 100\text{mA}, V_{BAT} = +3.0\text{V}$                                       |                 | 35  | 90              | $\text{m}\Omega$ |
| Disable Supply Current                                      | $I_{BAT\_DIS}$    | $V_{BAT} = +5.5\text{V}$<br>( $V_{JIG} = V_{S\_EN} = V_{ON\_K} = V_{TA} = V_{IN} = 0$ ) |                 |     | 1               | $\mu\text{A}$    |
| $V_{BAT}$ Supply Current                                    | $I_{BAT}$         | $V_{JIG} = V_{S\_EN} = V_{BAT}, V_{ON\_K} = V_{TA} = 0$                                 |                 | 0.8 | 4.5             | $\mu\text{A}$    |
| Increase in Supply Current with $V_{JIG}/V_{S\_EN}$ Voltage | $\Delta I_{BAT}$  | $V_{JIG} = V_{S\_EN} = V_{IH}$ or $V_{IL}$  |                 |     | 2               | $\mu\text{A}$    |
| Increase in Supply Current with $V_{ON\_K}$ Voltage         | $\Delta I_{BAT}$  | $V_{BAT} = V_{ON\_K} = +3.6\text{V}$  |                 |     | 4.5             | $\mu\text{A}$    |
| Peak Current  | $I_{LIM}$         | $V_{BAT} = +3.6\text{V}$  | 5               |     |                 | A                |
| UVLO Undervoltage Lockout                                   |                   | Ramping $V_{BAT}$   |                 |     | 1.9             | V                |
| <b>LOGIC INPUT</b>  |                   |   |                 |     |                 |                  |
| TA Threshold Voltage  | $V_{TA\_TH}$      |   | 1.15            | 1.7 | 2.5             | V                |
| TA Threshold Hysteresis                                     |                   |   |                 | 1%  |                 |                  |
| TA Input Resistance   |                   | $V_{TA} = 1\text{V}$  | 50              | 100 | 180             | $\text{k}\Omega$ |
| JIG, S_EN Input Logic-High                                  | $V_{IH}$          |   | 1.4             |     |                 | V                |
| JIG, S_EN Input Logic-Low                                   | $V_{IL}$          |   |                 |     | 0.4             | V                |
| JIG, S_EN Input Leakage Current                             | $I_{IN}$          | $V_{BAT} = +5.5\text{V}$  | -200            |     | +200            | nA               |
| IN AND Gate Threshold Voltage                               | $V_{IN\_TH}$      |   | 0.3 x $V_{BAT}$ |     | 0.6 x $V_{BAT}$ | V                |
| ON_K Threshold Voltage                                      | $V_{ON\_K\_TH}$   | Low-to-high transition<br>(Figure 1)  | 2.94            | 3.0 | 3.06            | V                |
| ON_K Threshold Hysteresis                                   |                   |   |                 | 1%  |                 |                  |

# Battery Switch with Four Enable Inputs

## ELECTRICAL CHARACTERISTICS (continued)

( $V_{BAT} = +2.2V$  to  $+5.5V$ ,  $T_A = -40^\circ C$  to  $+85^\circ C$ , unless otherwise noted. Typical values are at  $V_{BAT} = +3.6V$  and  $T_A = +25^\circ C$ .) (Note 2)

| PARAMETER  | SYMBOL        | CONDITIONS   | MIN | TYP  | MAX  | UNITS   |
|--|---------------|--|-----|------|------|---------|
| ON_K Input Leakage Current   | $I_{ON\_K}$   | $V_{BAT} = V_{ON\_K} = +3.6V$                        |     |      | 3    | $\mu A$ |
| <b>SWITCH DYNAMICS (<math>R_L = 20\Omega</math>, <math>C_L = 0.1\mu F</math>) (Figure 2)</b> |               |  |     |      |      |         |
| Turn-On Delay Time   | $t_{ONDLY}$   | From any enable high to $V_{IN} = 10\%$ of $V_{BAT}$ |     | 600  | 2600 | $\mu s$ |
| Turn-On Rise Time  | $t_{ONRISE}$  | $V_{IN}$ 10% to 90% of $V_{BAT}$                     | 500 | 1800 | 5000 | $\mu s$ |
| Turn-Off Delay Time  | $t_{OFFDLY}$  | From any enable low to $V_{IN} = 90\%$ of $V_{BAT}$  |     | 130  | 300  | $\mu s$ |
| Turn-Off Fall Time   | $t_{OFFFALL}$ | $V_{IN}$ 90% to 10% of $V_{BAT}$                     |     | 60   | 150  | $\mu s$ |

**Note 2:** Devices are tested at  $T_A = +25^\circ C$ . Specifications over temperature are guaranteed by design.

## Typical Operating Characteristics

( $V_{IN} = +3.6V$ ,  $T_A = +25^\circ C$ , unless otherwise noted.)

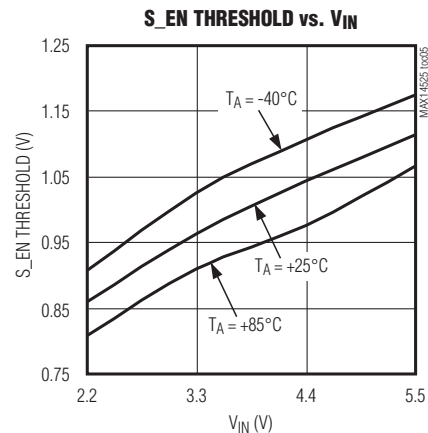
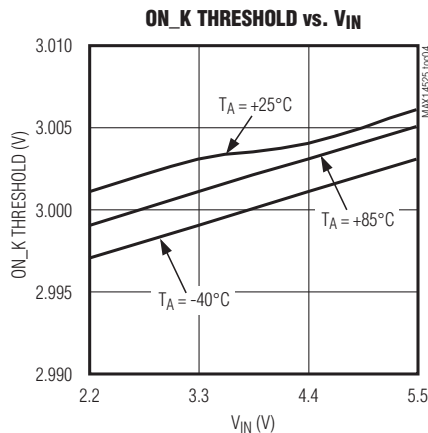
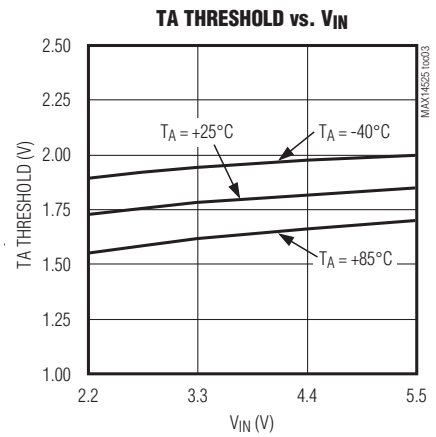
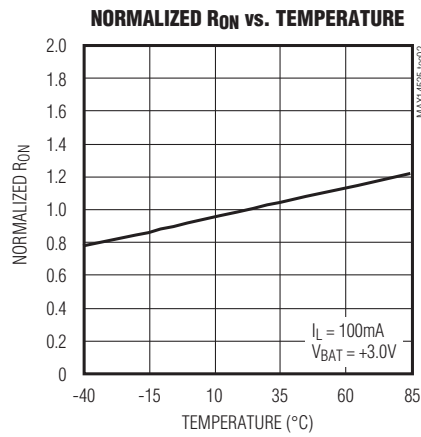
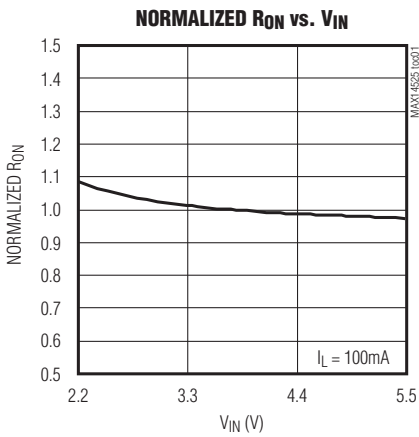

# Battery Switch with Four Enable Inputs

## Typical Operating Characteristics (continued)

( $V_{IN} = +3.6V$ ,  $T_A = +25^\circ C$ , unless otherwise noted.)

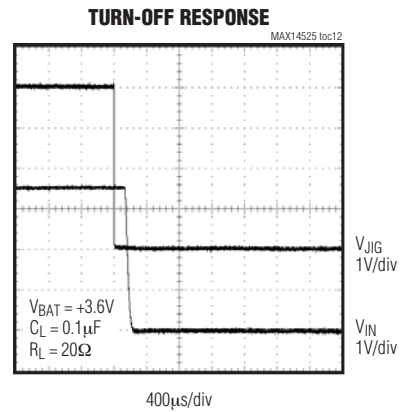
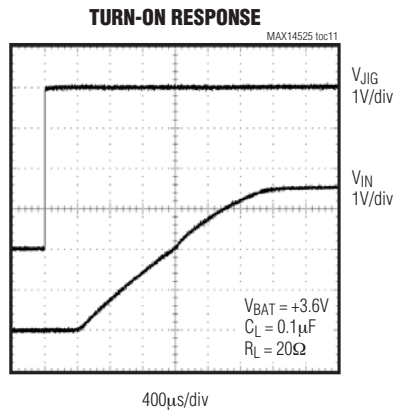
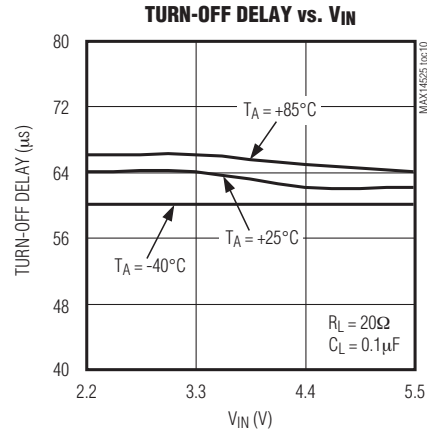
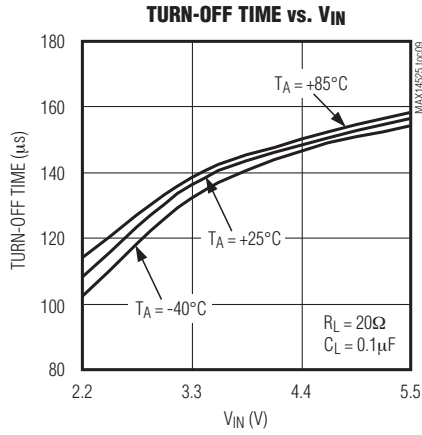
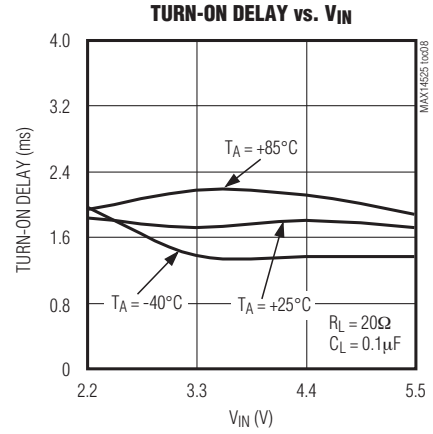
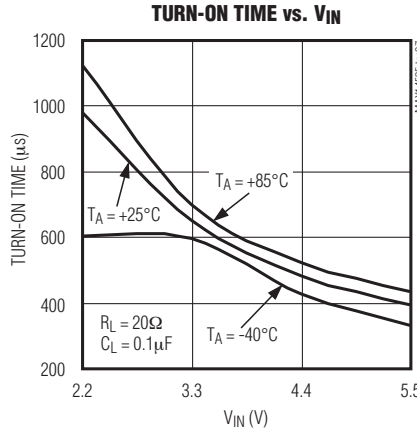
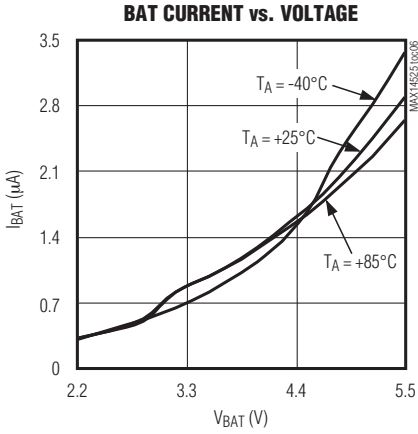

# Battery Switch with Four Enable Inputs

MAX14525

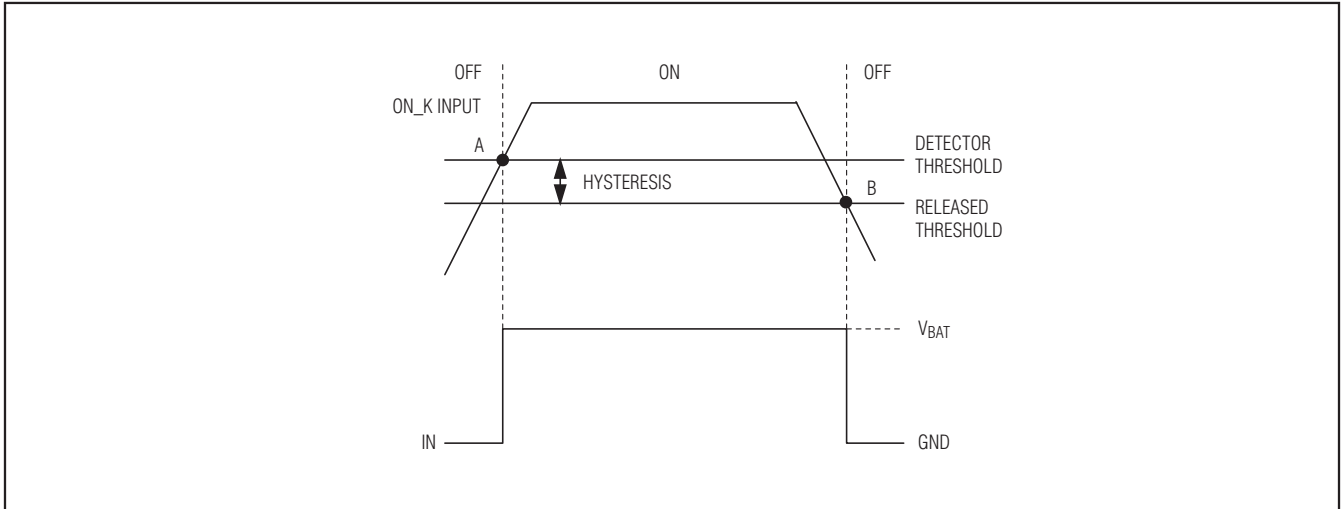

Figure 1. ON\_K Input Operation Diagram

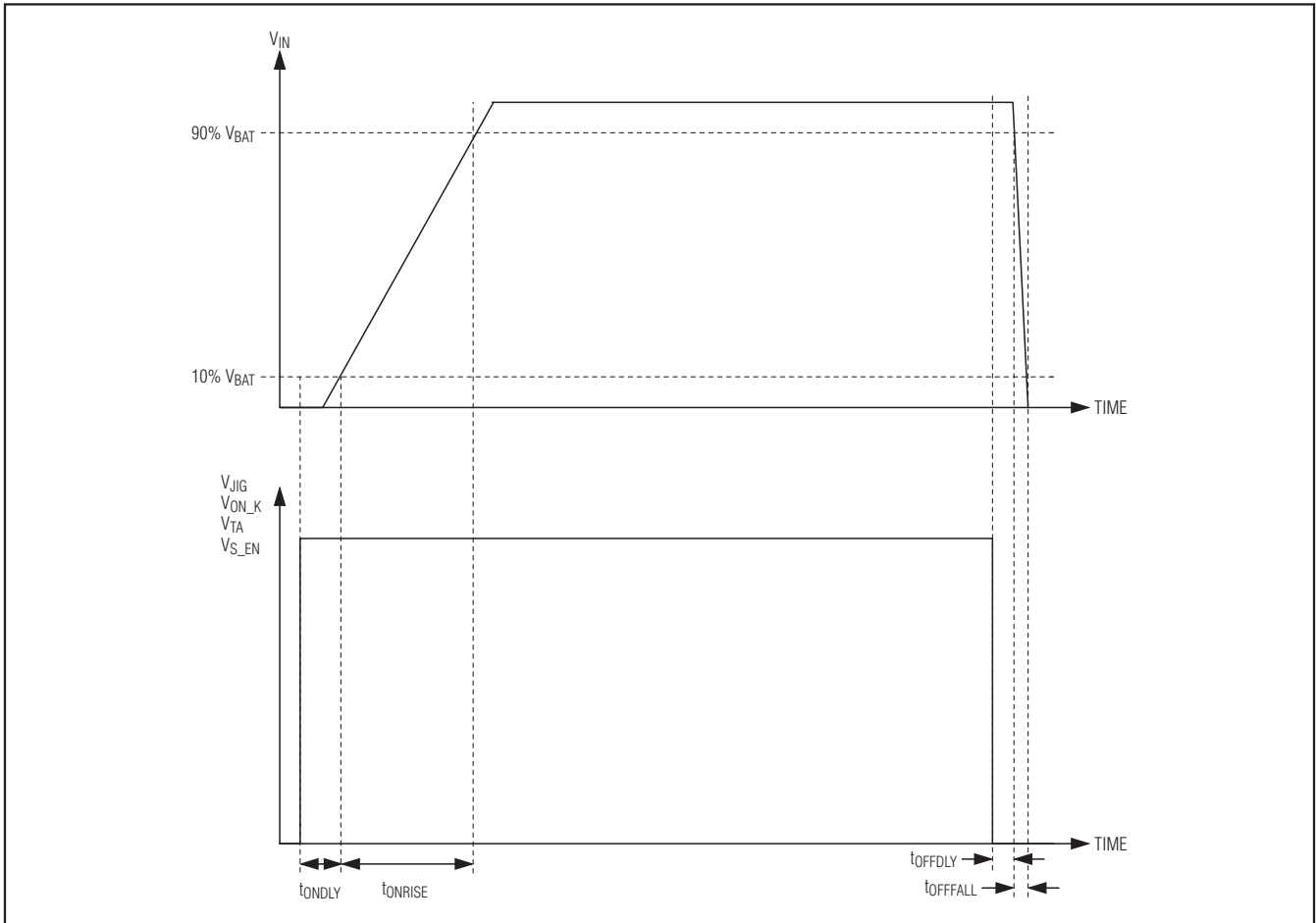

Figure 2. Turn-On Delay Time, Turn-On Rise Time, Turn-Off Delay Time, and Turn-Off Fall Time

# Battery Switch with Four Enable Inputs

## Pin Description

| PIN  | NAME | FUNCTION   |
|------|------|--|
| 1    | BAT  | Lithium-Ion (Li+) Battery Connection   |
| 2    | JIG  | Enable Input with Standard Logic Threshold   |
| 3    | ON_K | Enable Input with Accurate Threshold (+3.0V)   |
| 4    | S_EN | Enable Input with Standard Logic Threshold Logically ANDed with IN   |
| 5    | GND  | Ground   |
| 6    | TA   | Enable Input with High Threshold   |
| 7, 8 | IN   | Power Switch Input. The power switch input voltage range is from +2.2V to +5.5V. Connect a 0.1 $\mu$ F capacitor from IN to GND. Connect pins 7 and 8 together for proper operation. |
| —    | EP   | Exposed Pad. Connect EP to ground. Do not use EP as the only ground connection.  |

## Detailed Description

The MAX14525 features a low 35m $\Omega$  (typ) R<sub>ON</sub> load switch with four unique enable inputs. The MAX14525 can be used to disconnect the lithium-ion battery from the loads in portable devices such as cell phones. It operates from a +2.2V to +5.5V supply voltage.

The MAX14525 features an ultra-low 0.8 $\mu$ A (typ) quiescent supply current to maximize battery life in portable devices. The device is enabled from four possible inputs: external charge connection travel adapter (TA), on key (ON\_K), factory mode enable (JIG), and switch enable (S\_EN). The S\_EN input is internally ANDed with the switched battery connection (IN).

### TA Input

The TA input on the MAX14525 can be connected directly to the external charger source. The TA input is high-voltage capable (+28V max) and features a high threshold voltage to limit false voltage trips, and an input resistance of 100k $\Omega$  (typ) to ground.

### ON\_K Input

The ON\_K line is active high and is pulled up to the lithium-ion battery through a momentary push button switch. This input features an accurate voltage detector threshold which does not enable the load switch

until the battery threshold is above +3.0V  $\pm$ 2%. When the battery has a very low charge and the on key is pressed, the accurate threshold does not allow the phone to boot up.

### JIG Input

The JIG input on the MAX14525 is a logic-level input (+1.8V compatible) from an external source to indicate the device has been connected to a factory cable. This signal requires a standard logic-input threshold voltage (+1.4V high).

### S\_EN Input

The S\_EN input on the MAX14525 is a logic-level input (+1.8V compatible) from an external source used to hold the switch on when the triggering condition (TA, ON\_K, or JIG) is removed. The standard logic threshold voltage comes from the host microprocessor that pulls S\_EN high once the code has begun running on the microprocessor. The S\_EN input is internally ANDed with the voltage on IN. The IN connection to the AND gate thresholds are standard CMOS values of 1/3 and 2/3 of V<sub>BAT</sub>.

## Chip Information

PROCESS: CMOS

# Battery Switch with Four Enable Inputs

## Package Information

For the latest package outline information and land patterns, go to [www.maxim-ic.com/packages](http://www.maxim-ic.com/packages).

| PACKAGE TYPE | PACKAGE CODE | DOCUMENT NO.            |
|--------------|--------------|-------------------------|
| 8 TDFN-EP    | T822+2       | <a href="#">21-0168</a> |

**MAX14525**

Maxim cannot assume responsibility for use of any circuitry other than circuitry entirely embodied in a Maxim product. No circuit patent licenses are implied. Maxim reserves the right to change the circuitry and specifications without notice at any time.

**Maxim Integrated Products, 120 San Gabriel Drive, Sunnyvale, CA 94086 408-737-7600** \_\_\_\_\_ 7