



# Dual, SiGe, High-Linearity, 1700MHz to 2200MHz Downconversion Mixer with LO Buffer/Switch

MAX19995A

## General Description

The MAX19995A dual-channel downconverter is designed to provide 8.7dB of conversion gain, +24.8dBm input IP3, +13.5dBm 1dB input compression point, and a noise figure of 9.2dB for 1700MHz to 2200MHz diversity receiver applications. With an optimized LO frequency range of 1750MHz to 2700MHz, this mixer is ideal for high-side LO injection architectures. Low-side LO injection is supported by the MAX19995, which is pin-pin and functionally compatible with the MAX19995A.

In addition to offering excellent linearity and noise performance, the MAX19995A also yields a high level of component integration. This device includes two double-balanced passive mixer cores, two LO buffers, a dual-input LO selectable switch, and a pair of differential IF output amplifiers. Integrated on-chip baluns allow for single-ended RF and LO inputs. The MAX19995A requires a nominal LO drive of 0dBm and a typical supply current of 350mA at  $V_{CC} = 5.0V$ , or 242mA at  $V_{CC} = 3.3V$ .

The MAX19995/MAX19995A are pin compatible with the MAX19985/MAX19985A series of 700MHz to 1000MHz mixers and pin similar to the MAX19997A/MAX19999 series of 1800MHz to 4000MHz mixers, making this entire family of downconverters ideal for applications where a common PCB layout is used across multiple frequency bands.

The MAX19995A is available in a 6mm x 6mm, 36-pin thin QFN package with an exposed pad. Electrical performance is guaranteed over the extended temperature range ( $T_C = -40^{\circ}C$  to  $+85^{\circ}C$ ).

## Applications

- UMTS/WCDMA Base Stations
- LTE/WiMAX™ Base Stations
- TD-SCDMA Base Stations
- DCS1800/PCS1900 and GSM/EDGE Base Stations
- cdma2000® Base Stations
- Fixed Broadband Wireless Access
- Wireless Local Loop
- Private Mobile Radios
- Military Systems

WiMAX is a trademark of WiMAX Forum.

cdma2000 is a registered trademark of Telecommunications Industry Association.



Maxim Integrated Products 1

For pricing, delivery, and ordering information, please contact Maxim Direct at 1-888-629-4642 or visit Maxim's website at [www.maxim-ic.com](http://www.maxim-ic.com).

## Features

- ◆ 1700MHz to 2200MHz RF Frequency Range
- ◆ 1750MHz to 2700MHz LO Frequency Range
- ◆ 50MHz to 500MHz IF Frequency Range
- ◆ 8.7dB Typical Conversion Gain
- ◆ 9.2dB Typical Noise Figure
- ◆ +24.8dBm Typical Input IP3
- ◆ +13.5dBm Typical Input 1dB Compression Point
- ◆ 64dBc Typical 2LO-2RF Spurious Rejection at  $P_{RF} = -10dBm$
- ◆ Dual Channels Ideal for Diversity Receiver Applications
- ◆ 48dB Typical Channel-to-Channel Isolation
- ◆ Low -3dBm to +3dBm LO Drive
- ◆ Integrated LO Buffer
- ◆ Internal RF and LO Baluns for Single-Ended Inputs
- ◆ Built-In SPDT LO Switch with 48dB LO-to-LO Isolation and 50ns Switching Time
- ◆ Pin Compatible with the MAX19985/MAX19985A/MAX19995 Series of 700MHz to 2200MHz Mixers
- ◆ Pin Similar to the MAX19997A/MAX19999 Series of 1800MHz to 4000MHz Mixers
- ◆ Single 5.0V or 3.3V Supply
- ◆ External Current-Setting Resistors Provide Option for Operating Device in Reduced-Power/Reduced-Performance Mode

## Ordering Information

PART	TEMP RANGE	PIN-PACKAGE
MAX19995AETX+	-40°C to +85°C	36 Thin QFN-EP*
MAX19995AETX+T	-40°C to +85°C	36 Thin QFN-EP*

+Denotes a lead(Pb)-free/RoHS-compliant package.

\*EP = Exposed pad.

T = Tape and reel.

Pin Configuration/Functional Diagram appears at end of data sheet.

# Dual, SiGe, High-Linearity, 1700MHz to 2200MHz Downconversion Mixer with LO Buffer/Switch

MAX19995A

## ABSOLUTE MAXIMUM RATINGS

V <sub>CC</sub> to GND .....	-0.3V to +5.5V	θ <sub>JA</sub> (Notes 2, 3).....	+38°C/W
LO1, LO2 to GND .....	-0.3V to +0.3V	θ <sub>JC</sub> (Notes 1, 3).....	7.4°C/W
LOSEL to GND .....	-0.3V to (V <sub>CC</sub> + 0.3V)	Operating Case Temperature Range (Note 4) ....	-40°C to +85°C
RFMAIN, RFDIV, and LO_ Input Power .....	+15dBm	Junction Temperature .....	+150°C
RFMAIN, RFDIV Current (RF is DC shorted to GND through a balun).....	50mA	Storage Temperature Range .....	-65°C to +150°C
Continuous Power Dissipation (Note 1) .....	8.7W	Lead Temperature (soldering, 10s) .....	+300°C

**Note 1:** Based on junction temperature  $T_J = T_C + (\theta_{JC} \times V_{CC} \times I_{CC})$ . This formula can be used when the temperature of the exposed pad is known while the device is soldered down to a PCB. See the *Applications Information* section for details. The junction temperature must not exceed +150°C.

**Note 2:** Junction temperature  $T_J = T_A + (\theta_{JA} \times V_{CC} \times I_{CC})$ . This formula can be used when the ambient temperature of the PCB is known. The junction temperature must not exceed +150°C.

**Note 3:** Package thermal resistances were obtained using the method described in JEDEC specification JESD51-7, using a four-layer board. For detailed information on package thermal considerations, refer to [www.maxim-ic.com/thermal-tutorial](http://www.maxim-ic.com/thermal-tutorial).

**Note 4:** T<sub>C</sub> is the temperature on the exposed pad of the package. T<sub>A</sub> is the ambient temperature of the device and PCB.

Stresses beyond those listed under "Absolute Maximum Ratings" may cause permanent damage to the device. These are stress ratings only, and functional operation of the device at these or any other conditions beyond those indicated in the operational sections of the specifications is not implied. Exposure to absolute maximum rating conditions for extended periods may affect device reliability.

## 5.0V SUPPLY DC ELECTRICAL CHARACTERISTICS

(Typical Application Circuit, V<sub>CC</sub> = 4.75V to 5.25V, no input AC signals. T<sub>C</sub> = -40°C to +85°C, R1 = R4 = 681Ω, R2 = R5 = 1.5kΩ. Typical values are at V<sub>CC</sub> = 5.0V, T<sub>C</sub> = +25°C, unless otherwise noted. All parameters are production tested.)

PARAMETER	SYMBOL	CONDITIONS	MIN	TYP	MAX	UNITS
Supply Voltage	V <sub>CC</sub>		4.75	5	5.25	V
Supply Current	I <sub>CC</sub>	Total supply current, V <sub>CC</sub> = 5.0V		350	410	mA
LOSEL Input High Voltage	V <sub>IH</sub>		2			V
LOSEL Input Low Voltage	V <sub>IL</sub>				0.8	V
LOSEL Input Current	I <sub>IH</sub> and I <sub>IL</sub>		-10		+10	μA

## 3.3V SUPPLY DC ELECTRICAL CHARACTERISTICS

(Typical Application Circuit, V<sub>CC</sub> = 3.0V to 3.6V, no input AC signals. T<sub>C</sub> = -40°C to +85°C, R1 = R4 = 909Ω, R2 = R5 = 1kΩ. Typical values are at V<sub>CC</sub> = 3.3V, T<sub>C</sub> = +25°C, unless otherwise noted. Parameters are guaranteed by design and not production tested.)

PARAMETER	SYMBOL	CONDITIONS	MIN	TYP	MAX	UNITS
Supply Voltage	V <sub>CC</sub>		3.0	3.3	3.6	V
Supply Current	I <sub>CC</sub>	Total supply current		242	300	mA
LOSEL Input High Voltage	V <sub>IH</sub>			2		V
LOSEL Input Low Voltage	V <sub>IL</sub>			0.8		V

# Dual, SiGe, High-Linearity, 1700MHz to 2200MHz Downconversion Mixer with LO Buffer/Switch

MAX19995A

## RECOMMENDED AC OPERATING CONDITIONS

PARAMETER	SYMBOL	CONDITIONS	MIN	TYP	MAX	UNITS
RF Frequency	$f_{RF}$	(Note 5)	1700		2200	MHz
LO Frequency	$f_{LO}$	(Note 5)	1750		2700	MHz
IF Frequency	$f_{IF}$	Using Mini-Circuits TC4-1W-17 4:1 transformer as defined in the <i>Typical Application Circuit</i> , IF matching components affect the IF frequency range (Note 5)	100		500	MHz
		Using alternative Mini-Circuits TC4-1W-7A 4:1 transformer as defined in the <i>Typical Application Circuit</i> , IF matching components affect the IF frequency range (Note 5)	50		250	
LO Drive Level	$P_{LO}$		-3		+3	dBm

## 5.0V SUPPLY AC ELECTRICAL CHARACTERISTICS

(*Typical Application Circuit*,  $R1 = R4 = 681\Omega$ ,  $R2 = R5 = 1.5k\Omega$ ,  $V_{CC} = 4.75V$  to  $5.25V$ , RF and LO ports are driven from  $50\Omega$  sources,  $P_{LO} = -3dBm$  to  $+3dBm$ ,  $P_{RF} = -5dBm$ ,  $f_{RF} = 1700MHz$  to  $2000MHz$ ,  $f_{LO} = 2050MHz$  to  $2350MHz$ ,  $f_{IF} = 350MHz$ ,  $f_{RF} < f_{LO}$ ,  $T_C = -40^\circ C$  to  $+85^\circ C$ . Typical values are at  $V_{CC} = 5.0V$ ,  $P_{RF} = -5dBm$ ,  $P_{LO} = 0dBm$ ,  $f_{RF} = 1850MHz$ ,  $f_{LO} = 2200MHz$ ,  $f_{IF} = 350MHz$ ,  $T_C = +25^\circ C$ . All parameters are guaranteed by design and characterization, unless otherwise noted.) (Note 6)

PARAMETER	SYMBOL	CONDITIONS	MIN	TYP	MAX	UNITS
Conversion Gain	$G_C$		6.5	8.7	10.4	dB
		$T_C = +25^\circ C$ (Note 7)	7.1	8.7	9.9	
		$T_C = +25^\circ C$ , $f_{RF} = 1850MHz$ (Note 8)	7.7	8.7	9.7	
Conversion Gain Flatness	$\Delta G_C$	Flatness over any one of three frequency bands: $f_{RF} = 1710MHz$ to $1785MHz$		+0.07		dB
		$f_{RF} = 1850MHz$ to $1910MHz$		-0.03		
		$f_{RF} = 1920MHz$ to $1980MHz$		-0.13		
Gain Variation Over Temperature	$TC_{CG}$	$f_{RF} = 1700MHz$ to $2000MHz$ , $f_{LO} = 2050MHz$ to $2350MHz$ , $T_C = -40^\circ C$ to $+85^\circ C$		-0.011		dB/ $^\circ C$
Input Compression Point	$IP_{1dB}$	$f_{RF} = 1850MHz$ (Notes 7, 9)	9.5	13.5		dBm
Input Third-Order Intercept Point	$IIP3$	$f_{RF1} - f_{RF2} = 1MHz$ , $P_{RF} = -5dBm$ per tone	21.5	24.8		dBm
		$f_{RF1} - f_{RF2} = 1MHz$ , $P_{RF} = -5dBm$ per tone, $T_C = +25^\circ C$	22	24.8		
Input Third-Order Intercept Point Variation Over Temperature	$TC_{IIP3}$	$f_{RF1} - f_{RF2} = 1MHz$ , $P_{RF} = -5dBm$ per tone, $T_C = -40^\circ C$ to $+85^\circ C$		0.006		dBm/ $^\circ C$
Noise Figure (Note 10)	$NF_{SSB}$	Single sideband, no blockers present		9.2	11.1	dB
		$f_{RF} = 1850MHz$ , $f_{LO} = 2200MHz$ , $T_C = +25^\circ C$ , $P_{LO} = 0dBm$ , single sideband, no blockers present		9.2	9.8	
Noise Figure Temperature Coefficient	$TC_{NF}$	Single sideband, no blockers present, $T_C = -40^\circ C$ to $+85^\circ C$		0.016		dB/ $^\circ C$

# Dual, SiGe, High-Linearity, 1700MHz to 2200MHz Downconversion Mixer with LO Buffer/Switch

MAX19995A

## 5.0V SUPPLY AC ELECTRICAL CHARACTERISTICS (continued)

(Typical Application Circuit,  $R1 = R4 = 681\Omega$ ,  $R2 = R5 = 1.5k\Omega$ ,  $V_{CC} = 4.75V$  to  $5.25V$ , RF and LO ports are driven from  $50\Omega$  sources,  $P_{LO} = -3dBm$  to  $+3dBm$ ,  $P_{RF} = -5dBm$ ,  $f_{RF} = 1700MHz$  to  $2000MHz$ ,  $f_{LO} = 2050MHz$  to  $2350MHz$ ,  $f_{IF} = 350MHz$ ,  $f_{RF} < f_{LO}$ ,  $T_C = -40^\circ C$  to  $+85^\circ C$ . Typical values are at  $V_{CC} = 5.0V$ ,  $P_{RF} = -5dBm$ ,  $P_{LO} = 0dBm$ ,  $f_{RF} = 1850MHz$ ,  $f_{LO} = 2200MHz$ ,  $f_{IF} = 350MHz$ ,  $T_C = +25^\circ C$ . All parameters are guaranteed by design and characterization, unless otherwise noted.) (Note 6)

PARAMETER	SYMBOL	CONDITIONS	MIN	TYP	MAX	UNITS
Noise Figure with Blocker	$N_{FB}$	$P_{BLOCKER} = +8dBm$ , $f_{RF} = 1850MHz$ , $f_{LO} = 2200MHz$ , $f_{BLOCKER} = 1725MHz$ , $P_{LO} = 0dBm$ , $V_{CC} = 5.0V$ , $T_C = +25^\circ C$ (Notes 10, 11)		19.7	23.4	dB
2LO-2RF Spur Rejection (Note 10)	2 x 2	$f_{RF} = 1850MHz$ , $f_{LO} = 2200MHz$ , $f_{SPUR} = 2025MHz$	$P_{RF} = -10dBm$	54	64	dBc
			$P_{RF} = -5dBm$	49	59	
		$f_{RF} = 1850MHz$ , $f_{LO} = 2200MHz$ , $f_{SPUR} = 2025MHz$ , $P_{LO} = 0dBm$ , $V_{CC} = 5.0V$ , $T_C = +25^\circ C$	$P_{RF} = -10dBm$	57	64	
			$P_{RF} = -5dBm$	52	59	
3LO-3RF Spur Rejection (Note 10)	3 x 3	$f_{RF} = 1850MHz$ , $f_{LO} = 2200MHz$ , $f_{SPUR} = 2083.33MHz$	$P_{RF} = -10dBm$	70	80	dBc
			$P_{RF} = -5dBm$	60	70	
		$f_{RF} = 1850MHz$ , $f_{LO} = 2200MHz$ , $f_{SPUR} = 2083.33MHz$ , $P_{LO} = 0dBm$ , $V_{CC} = 5.0V$ , $T_C = +25^\circ C$	$P_{RF} = -10dBm$	71	80	
			$P_{RF} = -5dBm$	61	70	
RF Input Return Loss		LO and IF terminated into matched impedance, LO on		21		dB
LO Input Return Loss		LO port selected, RF and IF terminated into matched impedance		20		dB
		LO port unselected, RF and IF terminated into matched impedance		22		
IF Output Impedance	$Z_{IF}$	Nominal differential impedance of the IF outputs		200		$\Omega$
IF Output Return Loss		RF terminated into $50\Omega$ , LO driven by $50\Omega$ source, IF transformed to $50\Omega$ using external components shown in the <i>Typical Application Circuit</i>		11.5		dB
RF-to-IF Isolation		(Note 8)	31	35		dB
LO Leakage at RF Port		(Note 8)		-35	-25	dBm
2LO Leakage at RF Port		(Note 8)		-17.5	-14	dBm
LO Leakage at IF Port		(Note 8)		-32	-22	dBm

# Dual, SiGe, High-Linearity, 1700MHz to 2200MHz Downconversion Mixer with LO Buffer/Switch

MAX19995A

## 5.0V SUPPLY AC ELECTRICAL CHARACTERISTICS (continued)

(Typical Application Circuit,  $R1 = R4 = 681\Omega$ ,  $R2 = R5 = 1.5k\Omega$ ,  $V_{CC} = 4.75V$  to  $5.25V$ , RF and LO ports are driven from  $50\Omega$  sources,  $P_{LO} = -3dBm$  to  $+3dBm$ ,  $P_{RF} = -5dBm$ ,  $f_{RF} = 1700MHz$  to  $2000MHz$ ,  $f_{LO} = 2050MHz$  to  $2350MHz$ ,  $f_{IF} = 350MHz$ ,  $f_{RF} < f_{LO}$ ,  $T_C = -40^\circ C$  to  $+85^\circ C$ . Typical values are at  $V_{CC} = 5.0V$ ,  $P_{RF} = -5dBm$ ,  $P_{LO} = 0dBm$ ,  $f_{RF} = 1850MHz$ ,  $f_{LO} = 2200MHz$ ,  $f_{IF} = 350MHz$ ,  $T_C = +25^\circ C$ . All parameters are guaranteed by design and characterization, unless otherwise noted.) (Note 6)

PARAMETER	SYMBOL	CONDITIONS	MIN	TYP	MAX	UNITS
Channel Isolation (Note 7)		RFMAIN converted power measured at IFDIV relative to IFMAIN, all unused ports terminated to $50\Omega$	40	48		dB
		RFDIV converted power measured at IFMAIN relative to IFDIV, all unused ports terminated to $50\Omega$	40	48		
LO-to-LO Isolation		$P_{LO1} = +3dBm$ , $P_{LO2} = +3dBm$ , $f_{LO1} = 2200MHz$ , $f_{LO2} = 2201MHz$ (Note 7)	40	48		dB
LO Switching Time		50% of LOSEL to IF settled within 2 degrees		50		ns

## 3.3V SUPPLY AC ELECTRICAL CHARACTERISTICS

(Typical Application Circuit,  $R1 = R4 = 909\Omega$ ,  $R2 = R5 = 1k\Omega$ . Typical values are at  $V_{CC} = 3.3V$ ,  $P_{RF} = -5dBm$ ,  $P_{LO} = 0dBm$ ,  $f_{RF} = 1850MHz$ ,  $f_{LO} = 2200MHz$ ,  $f_{IF} = 350MHz$ ,  $T_C = +25^\circ C$ , unless otherwise noted.) (Note 6)

PARAMETER	SYMBOL	CONDITIONS	MIN	TYP	MAX	UNITS
Conversion Gain	$G_C$	(Note 8)		8.4		dB
Conversion Gain Flatness	$\Delta G_C$	Flatness over any one of three frequency bands: $f_{RF} = 1710MHz$ to $1785MHz$		+0.07		dB
		$f_{RF} = 1850MHz$ to $1910MHz$		-0.03		
		$f_{RF} = 1920MHz$ to $1980MHz$		-0.13		
Gain Variation Over Temperature	$T_{CCG}$	$T_C = -40^\circ C$ to $+85^\circ C$		-0.013		dB/ $^\circ C$
Input Compression Point	$IP_{1dB}$	(Note 9)		10.2		dBm
Input Third-Order Intercept Point	$IIP3$	$f_{RF1} - f_{RF2} = 1MHz$		22.5		dBm
Input Third-Order Intercept Point Variation Over Temperature	$TC_{IIP3}$	$f_{RF1} - f_{RF2} = 1MHz$ , $P_{RF} = -5dBm$ per tone, $T_C = -40^\circ C$ to $+85^\circ C$		0.0017		dBm/ $^\circ C$
Noise Figure	$NF_{SSB}$	Single sideband, no blockers present		9		dB
Noise Figure Temperature Coefficient	$TC_{NF}$	Single sideband, no blockers present, $T_C = -40^\circ C$ to $+85^\circ C$		0.016		dB/ $^\circ C$
2LO-2RF Spur Rejection	$2 \times 2$	$P_{RF} = -10dBm$		65		dBc
		$P_{RF} = -5dBm$		60		
3LO-3RF Spur Rejection	$3 \times 3$	$P_{RF} = -10dBm$		77		dBc
		$P_{RF} = -5dBm$		67		
RF Input Return Loss		LO and IF terminated into matched impedance, LO on		25		dB

# Dual, SiGe, High-Linearity, 1700MHz to 2200MHz Downconversion Mixer with LO Buffer/Switch

MAX19995A

## 3.3V SUPPLY AC ELECTRICAL CHARACTERISTICS (continued)

(Typical Application Circuit, R1 = R4 = 909 $\Omega$ , R2 = R5 = 1k $\Omega$ . Typical values are at V<sub>CC</sub> = 3.3V, P<sub>RF</sub> = -5dBm, P<sub>LO</sub> = 0dBm, f<sub>RF</sub> = 1850MHz, f<sub>LO</sub> = 2200MHz, f<sub>IF</sub> = 350MHz, T<sub>C</sub> = +25°C, unless otherwise noted.) (Note 6)

PARAMETER	SYMBOL	CONDITIONS	MIN	TYP	MAX	UNITS
LO Input Return Loss		LO port selected, RF and IF terminated into matched impedance		22		dB
		LO port unselected, RF and IF terminated into matched impedance		16		
IF Output Return Loss		RF terminated into 50 $\Omega$ , LO driven by 50 $\Omega$ source, IF transformed to 50 $\Omega$ using external components shown in the <i>Typical Application Circuit</i>		11.5		dB
RF-to-IF Isolation				36		dB
LO Leakage at RF Port				-40		dBm
2LO Leakage at RF Port				-23		dBm
LO Leakage at IF Port				-37		dBm
Channel Isolation		RFMAIN converted power measured at IFDIV relative to IFMAIN, all unused ports terminated to 50 $\Omega$		48		dB
		RFDIV converted power measured at IFMAIN relative to IFDIV, all unused ports terminated to 50 $\Omega$		48		
LO-to-LO Isolation		P <sub>LO1</sub> = +3dBm, P <sub>LO2</sub> = +3dBm, f <sub>LO1</sub> = 2200MHz, f <sub>LO2</sub> = 2201MHz		47		dB
LO Switching Time		50% of LOSEL to IF settled within 2 degrees		50		ns

**Note 5:** Not production tested. Operation outside this range is possible, but with degraded performance of some parameters. See the *Typical Operating Characteristics*.

**Note 6:** All limits reflect losses of external components, including a 0.9dB loss at f<sub>IF</sub> = 350MHz due to the 4:1 transformer. Output measurements were taken at IF outputs of the *Typical Application Circuit*.

**Note 7:** 100% production tested.

**Note 8:** 100% production tested for functionality.

**Note 9:** Maximum reliable continuous input power applied to the RF or IF port of this device is +12dBm from a 50 $\Omega$  source.

**Note 10:** Not production tested.

**Note 11:** Measured with external LO source noise filtered so the noise floor is -174dBm/Hz. This specification reflects the effects of all SNR degradations in the mixer, including the LO noise as defined in Application Note 2021: *Specifications and Measurement of Local Oscillator Noise in Integrated Circuit Base Station Mixers*.

# Dual, SiGe, High-Linearity, 1700MHz to 2200MHz Downconversion Mixer with LO Buffer/Switch

## Typical Operating Characteristics

(Typical Application Circuit,  $R1 = R4 = 681\Omega$ ,  $R2 = R5 = 1.5k\Omega$ ,  $V_{CC} = 5.0V$ ,  $P_{RF} = -5dBm$ ,  $P_{LO} = 0dBm$ ,  $f_{RF} = 1850MHz$ ,  $f_{LO} = 2200MHz$ ,  $f_I = 350MHz$ ,  $T_C = +25^\circ C$ , unless otherwise noted.)

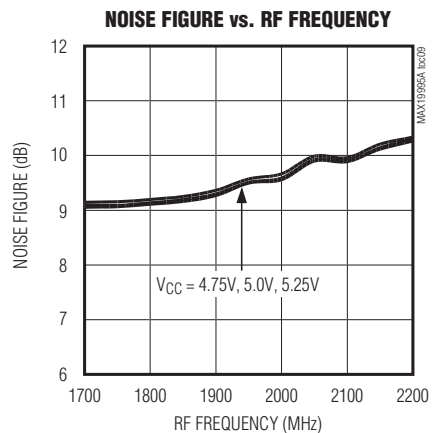
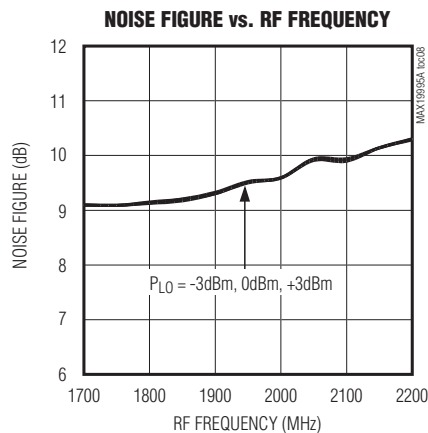
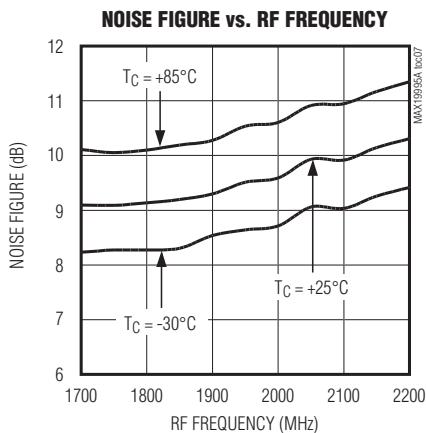
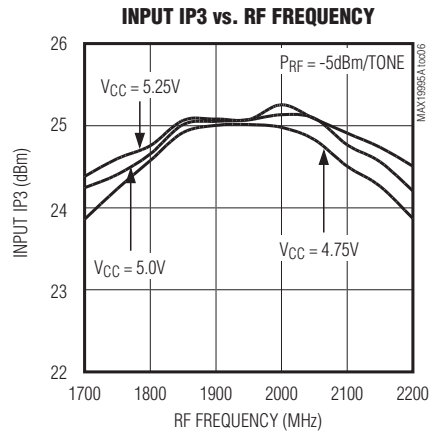
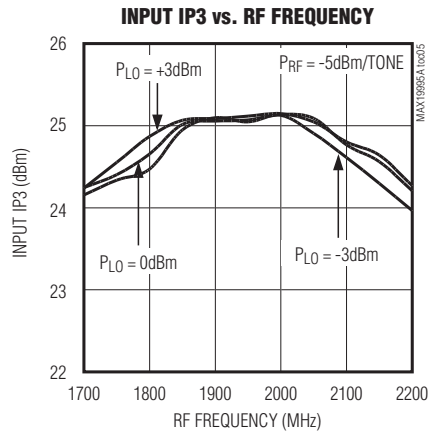
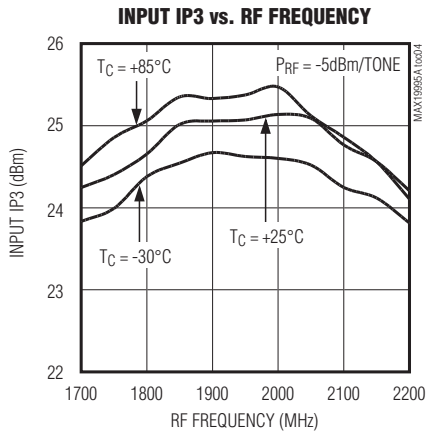
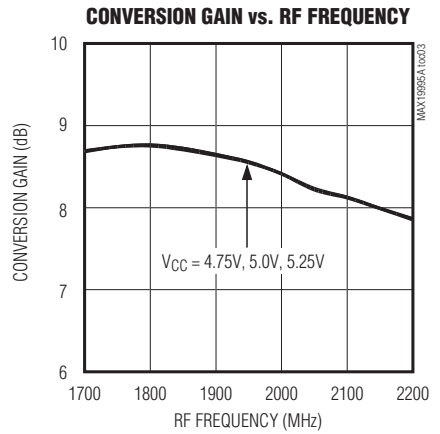
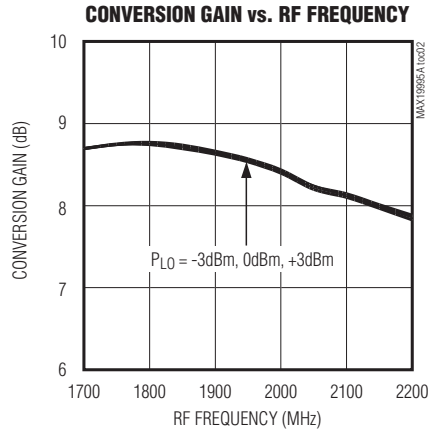
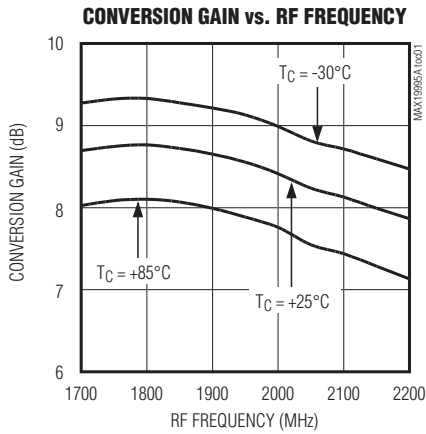

# Dual, SiGe, High-Linearity, 1700MHz to 2200MHz Downconversion Mixer with LO Buffer/Switch

## Typical Operating Characteristics (continued)

(Typical Application Circuit,  $R1 = R4 = 681\Omega$ ,  $R2 = R5 = 1.5k\Omega$ ,  $V_{CC} = 5.0V$ ,  $P_{RF} = -5dBm$ ,  $P_{LO} = 0dBm$ ,  $f_{RF} = 1850MHz$ ,  $f_{LO} = 2200MHz$ ,  $f_I = 350MHz$ ,  $T_C = +25^\circ C$ , unless otherwise noted.)

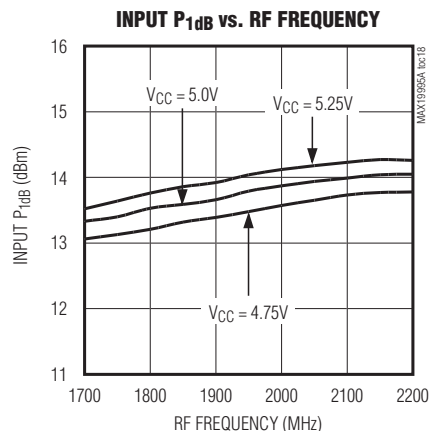
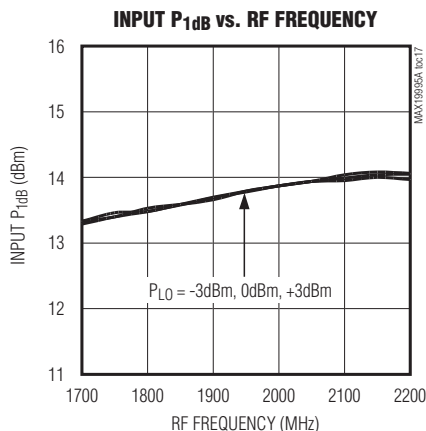
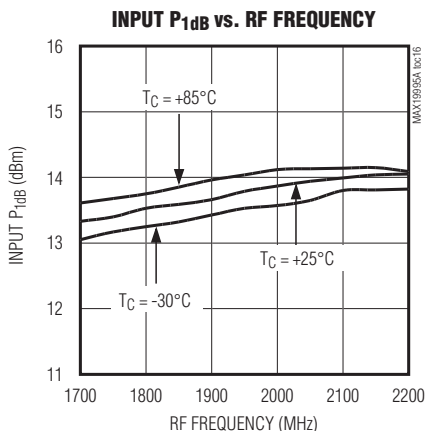
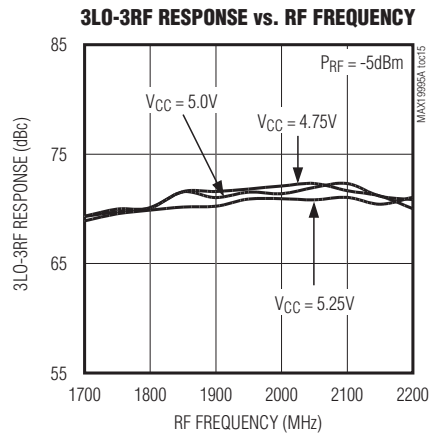
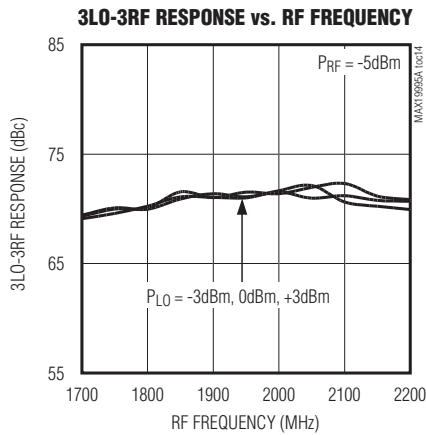
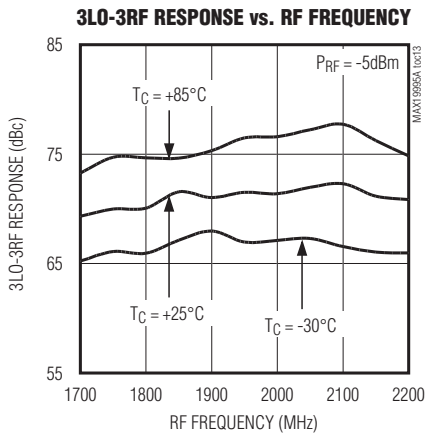
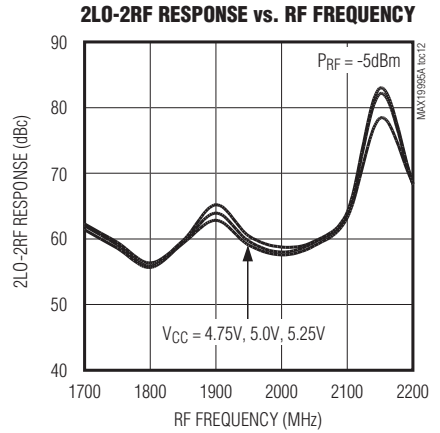
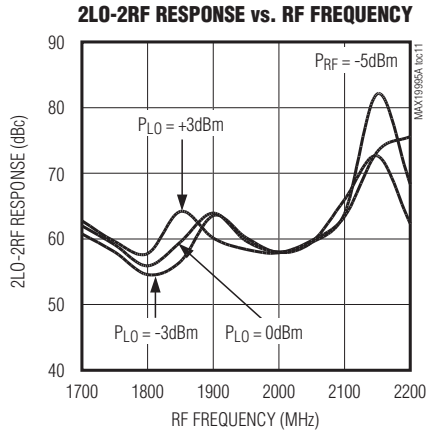
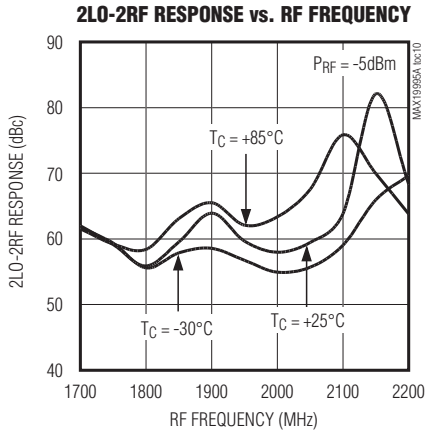



# Dual, SiGe, High-Linearity, 1700MHz to 2200MHz Downconversion Mixer with LO Buffer/Switch

## Typical Operating Characteristics (continued)

(Typical Application Circuit,  $R1 = R4 = 681\Omega$ ,  $R2 = R5 = 1.5k\Omega$ ,  $V_{CC} = 5.0V$ ,  $P_{RF} = -5dBm$ ,  $P_{LO} = 0dBm$ ,  $f_{RF} = 1850MHz$ ,  $f_{LO} = 2200MHz$ ,  $f_{IF} = 350MHz$ ,  $T_C = +25^\circ C$ , unless otherwise noted.)

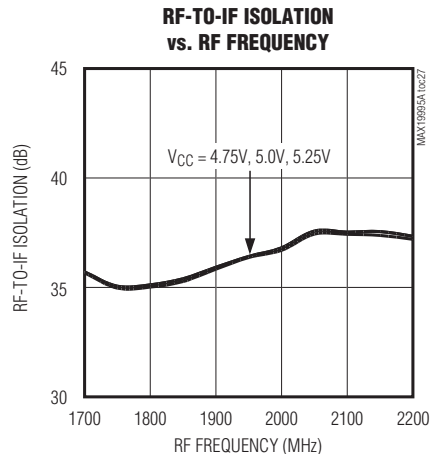
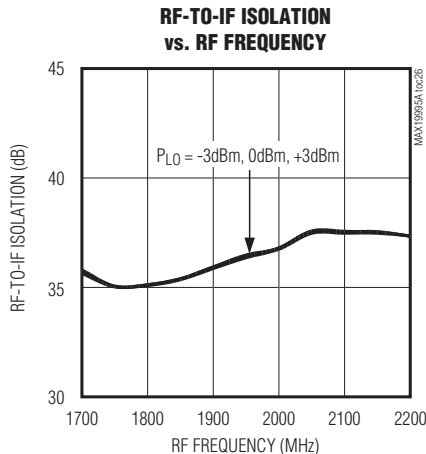
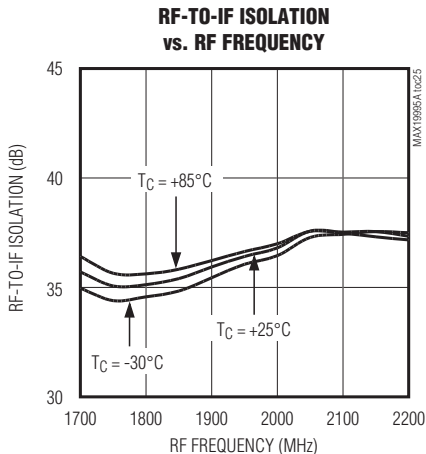
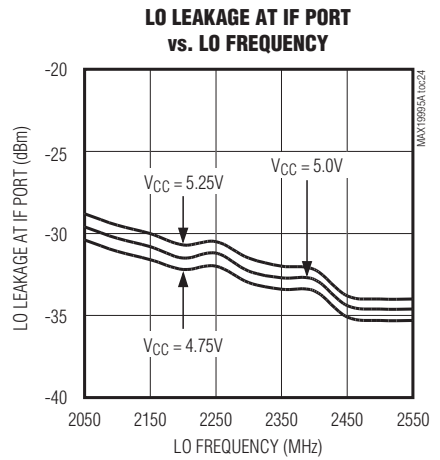
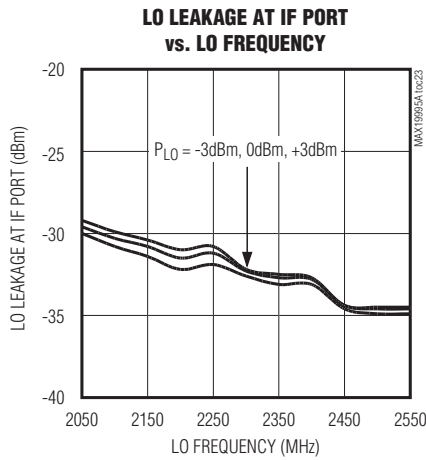
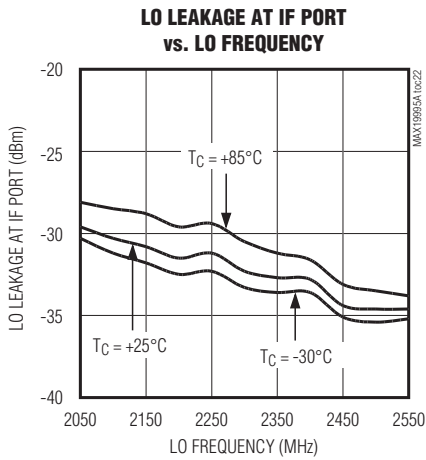
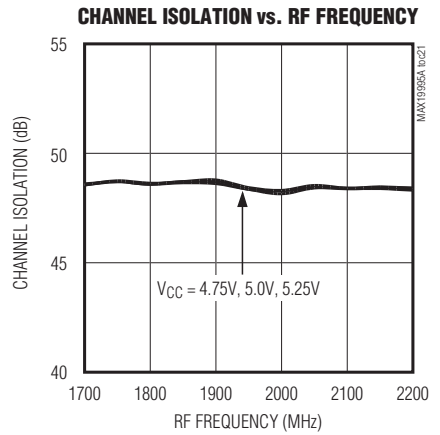
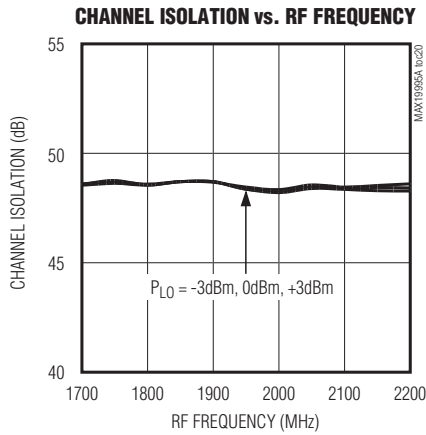
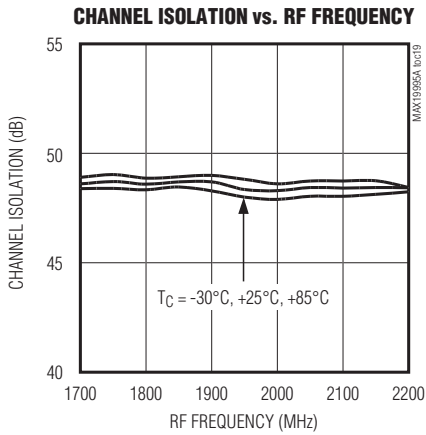

# Dual, SiGe, High-Linearity, 1700MHz to 2200MHz Downconversion Mixer with LO Buffer/Switch

## Typical Operating Characteristics (continued)

(Typical Application Circuit,  $R1 = R4 = 681\Omega$ ,  $R2 = R5 = 1.5k\Omega$ ,  $V_{CC} = 5.0V$ ,  $P_{RF} = -5dBm$ ,  $P_{LO} = 0dBm$ ,  $f_{RF} = 1850MHz$ ,  $f_{LO} = 2200MHz$ ,  $f_{IF} = 350MHz$ ,  $T_C = +25^\circ C$ , unless otherwise noted.)

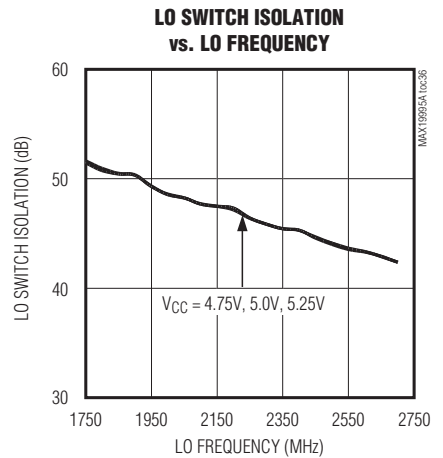
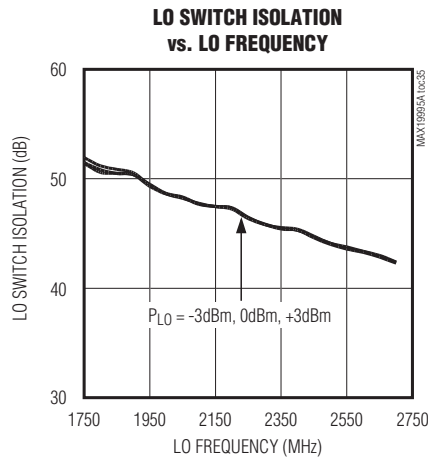
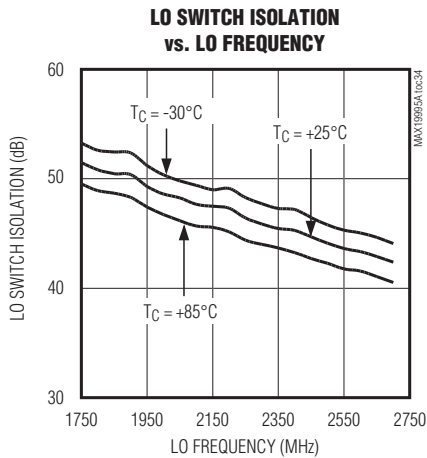
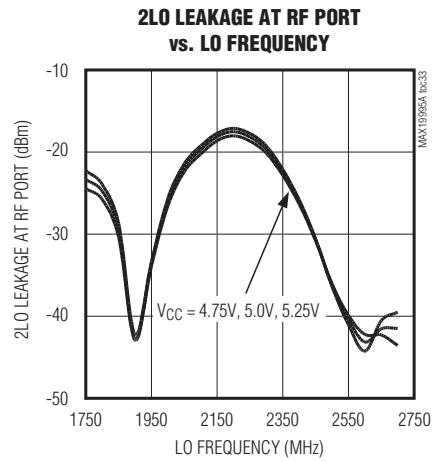
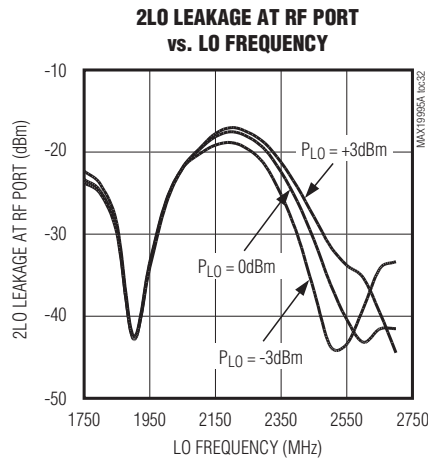
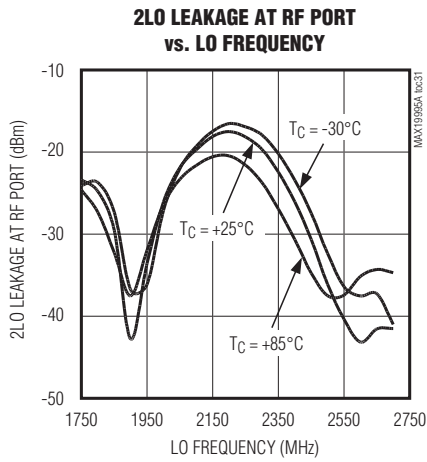
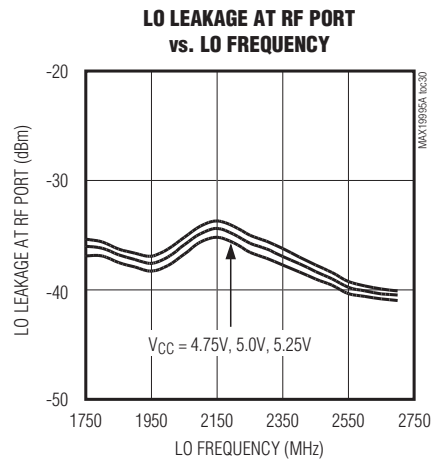
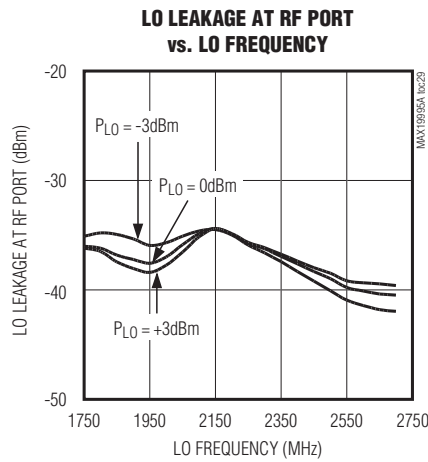
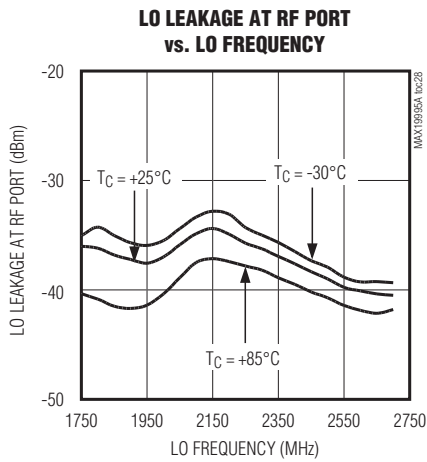

# Dual, SiGe, High-Linearity, 1700MHz to 2200MHz Downconversion Mixer with LO Buffer/Switch

## Typical Operating Characteristics (continued)

(Typical Application Circuit,  $R1 = R4 = 681\Omega$ ,  $R2 = R5 = 1.5k\Omega$ ,  $V_{CC} = 5.0V$ ,  $P_{RF} = -5dBm$ ,  $P_{LO} = 0dBm$ ,  $f_{RF} = 1850MHz$ ,  $f_{LO} = 2200MHz$ ,  $f_{IF} = 350MHz$ ,  $T_C = +25^\circ C$ , unless otherwise noted.)

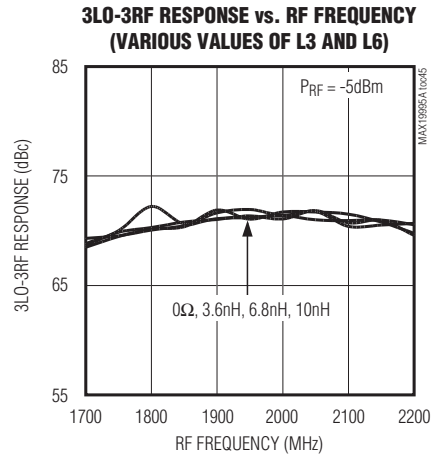
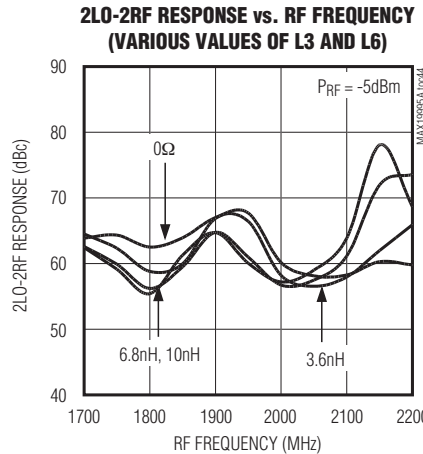
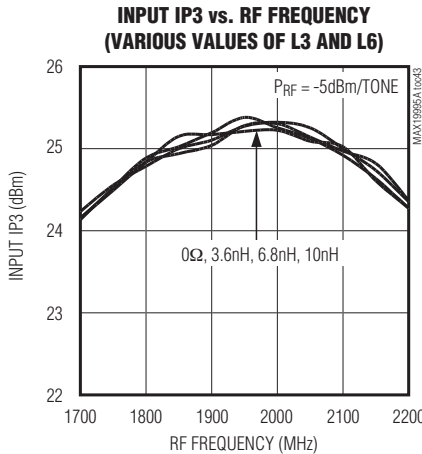
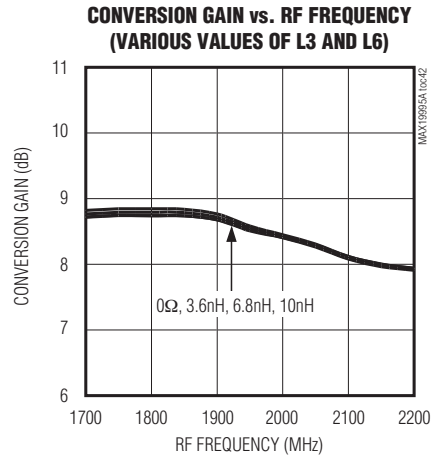
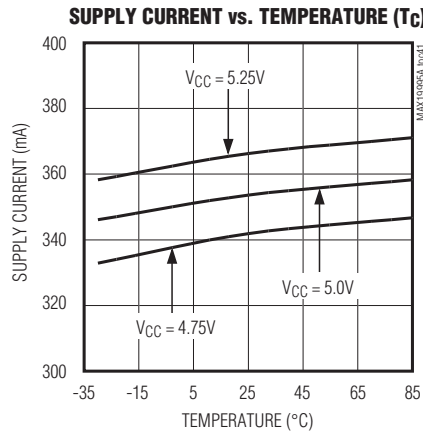
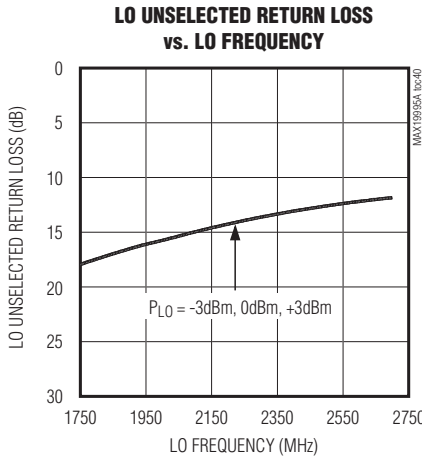
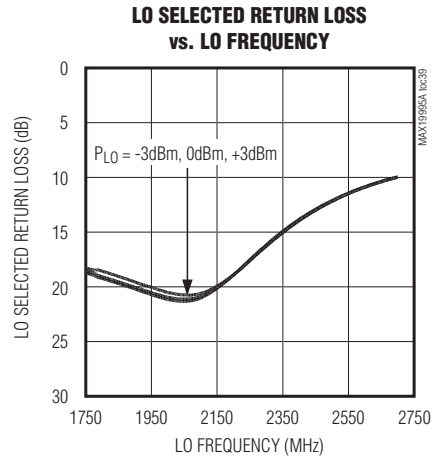
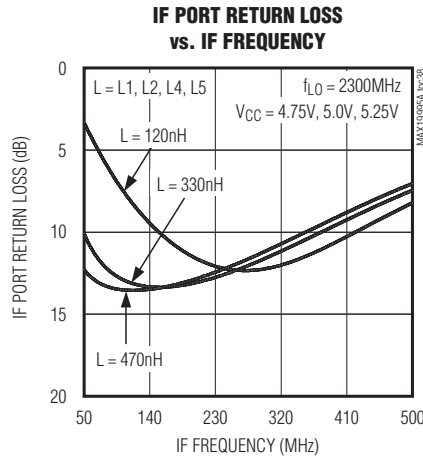
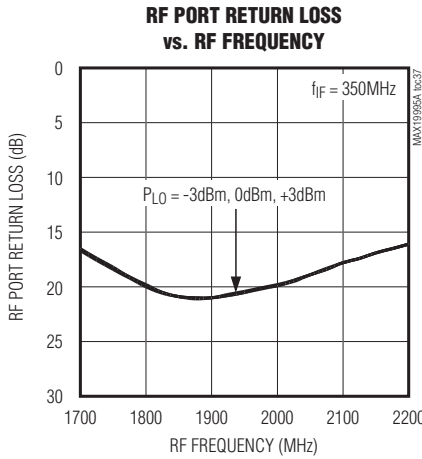

# Dual, SiGe, High-Linearity, 1700MHz to 2200MHz Downconversion Mixer with LO Buffer/Switch

## Typical Operating Characteristics (continued)

(Typical Application Circuit,  $R1 = R4 = 681\Omega$ ,  $R2 = R5 = 1.5k\Omega$ ,  $V_{CC} = 5.0V$ ,  $P_{RF} = -5dBm$ ,  $P_{LO} = 0dBm$ ,  $f_{RF} = 1850MHz$ ,  $f_{LO} = 2200MHz$ ,  $f_{IF} = 350MHz$ ,  $T_C = +25^\circ C$ , unless otherwise noted.)

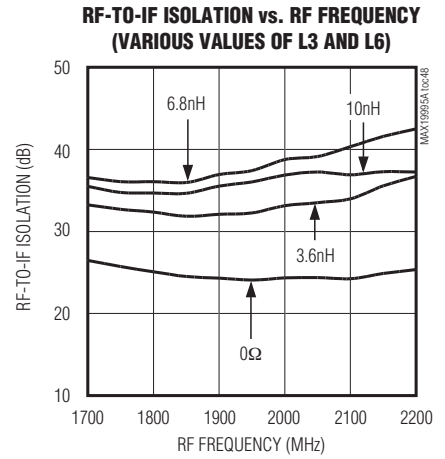
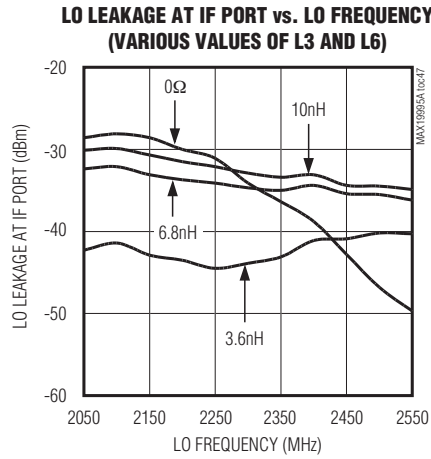
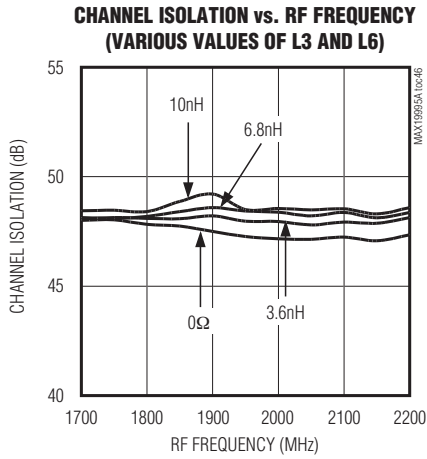

# Dual, SiGe, High-Linearity, 1700MHz to 2200MHz Downconversion Mixer with LO Buffer/Switch

## Typical Operating Characteristics

(Typical Application Circuit,  $R1 = R4 = 909\Omega$ ,  $R2 = R5 = 1k\Omega$ ,  $V_{CC} = 3.3V$ ,  $P_{RF} = -5dBm$ ,  $P_{LO} = 0dBm$ ,  $f_{RF} = 1850MHz$ ,  $f_{LO} = 2200MHz$ ,  $f_{IF} = 350MHz$ ,  $T_C = +25^\circ C$ , unless otherwise noted.)

**MAX19995A**

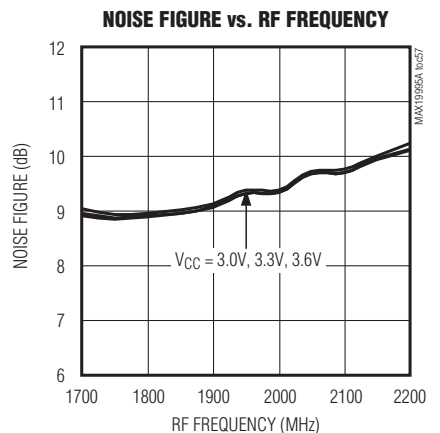
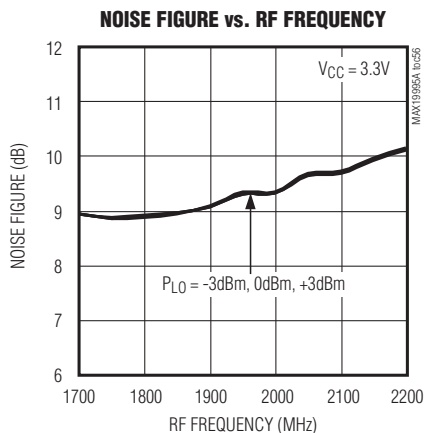
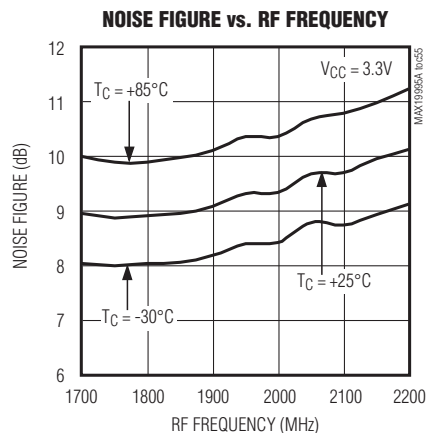
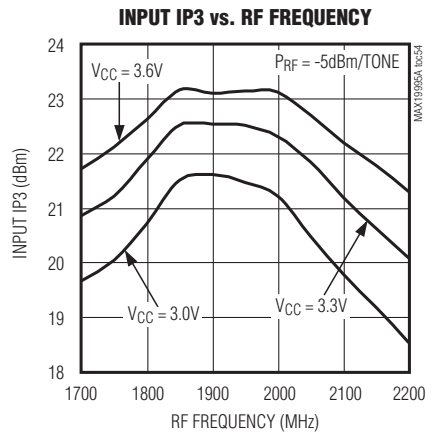
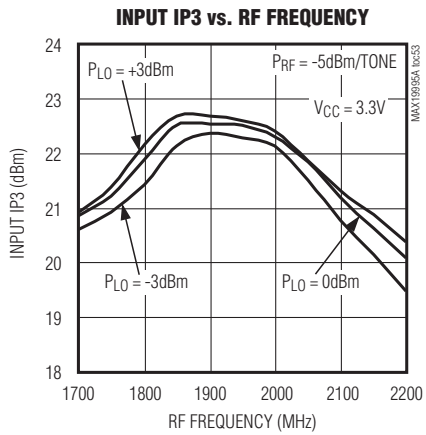
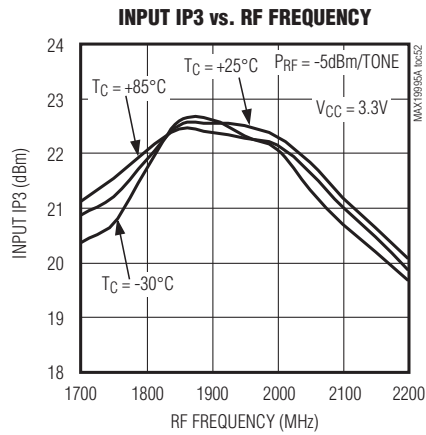
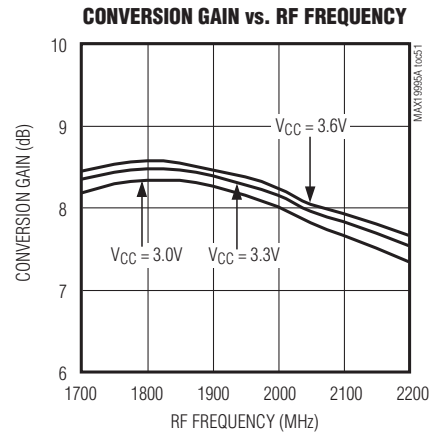
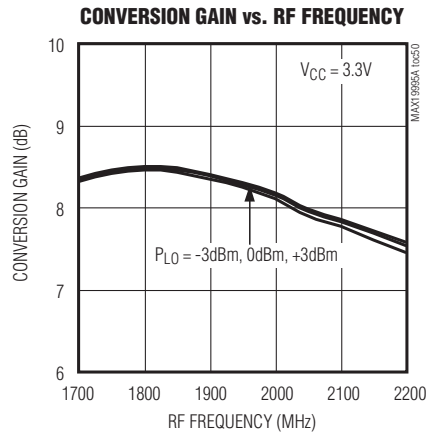
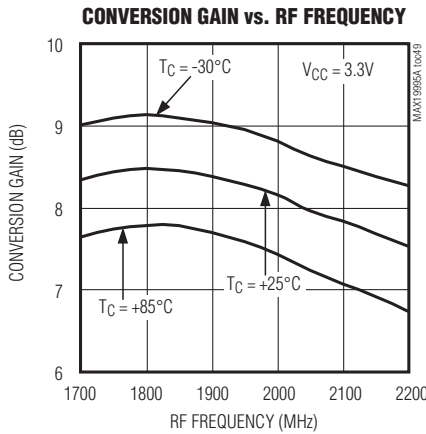

# Dual, SiGe, High-Linearity, 1700MHz to 2200MHz Downconversion Mixer with LO Buffer/Switch

## Typical Operating Characteristics (continued)

(Typical Application Circuit,  $R1 = R4 = 909\Omega$ ,  $R2 = R5 = 1k\Omega$ ,  $V_{CC} = 3.3V$ ,  $P_{RF} = -5dBm$ ,  $P_{LO} = 0dBm$ ,  $f_{RF} = 1850MHz$ ,  $f_{LO} = 2200MHz$ ,  $f_I = 350MHz$ ,  $T_C = +25^\circ C$ , unless otherwise noted.)

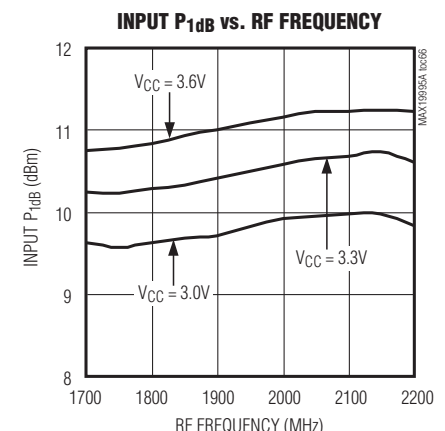
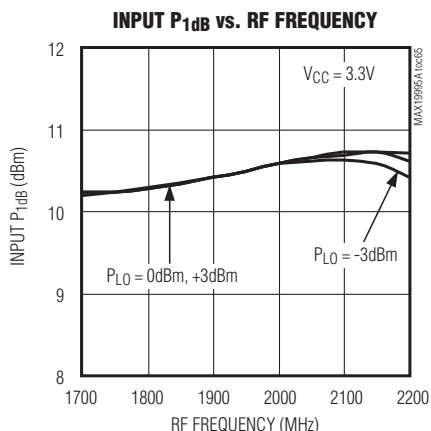
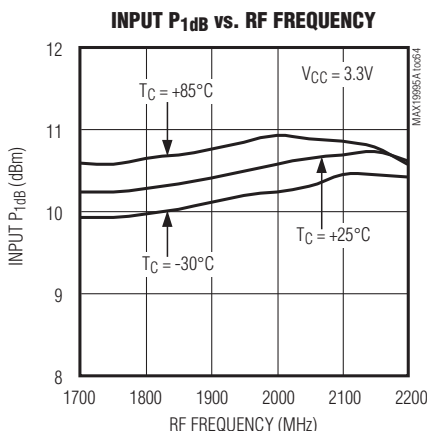
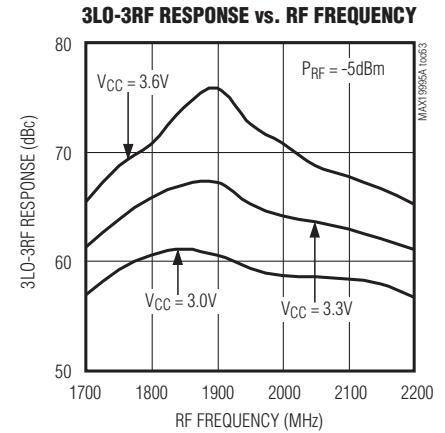
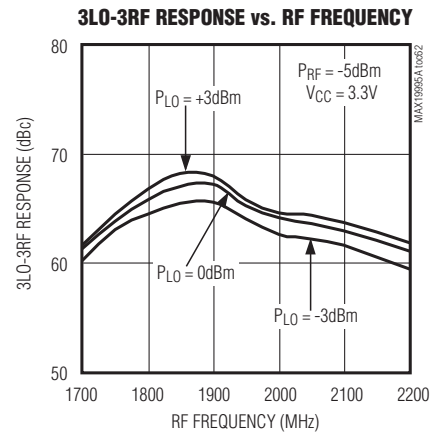
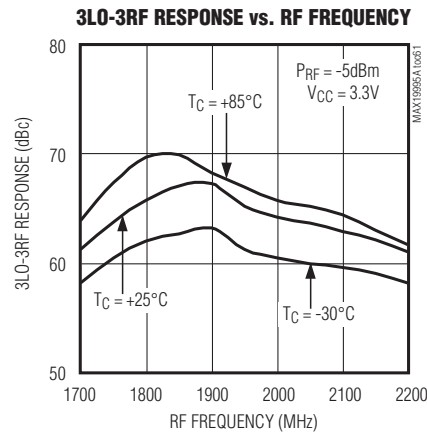
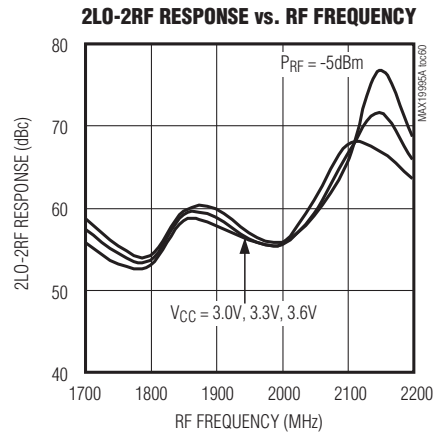
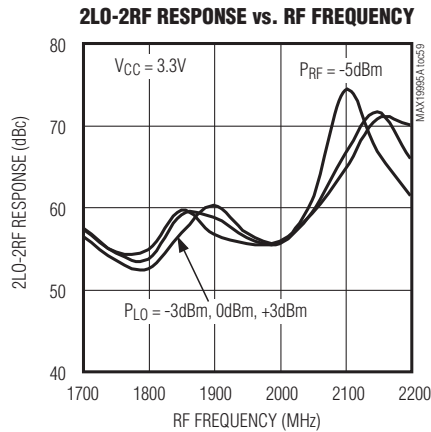
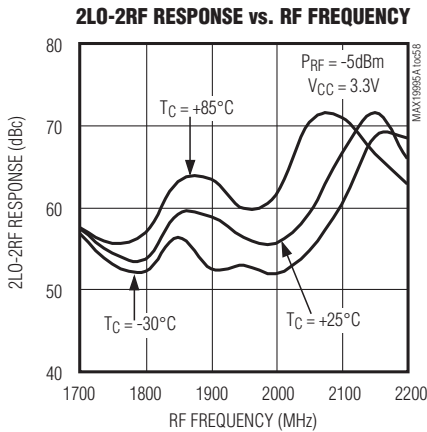

# Dual, SiGe, High-Linearity, 1700MHz to 2200MHz Downconversion Mixer with LO Buffer/Switch

## Typical Operating Characteristics (continued)

(Typical Application Circuit,  $R1 = R4 = 909\Omega$ ,  $R2 = R5 = 1k\Omega$ ,  $V_{CC} = 3.3V$ ,  $P_{RF} = -5dBm$ ,  $P_{LO} = 0dBm$ ,  $f_{RF} = 1850MHz$ ,  $f_{LO} = 2200MHz$ ,  $f_{IF} = 350MHz$ ,  $T_C = +25^\circ C$ , unless otherwise noted.)

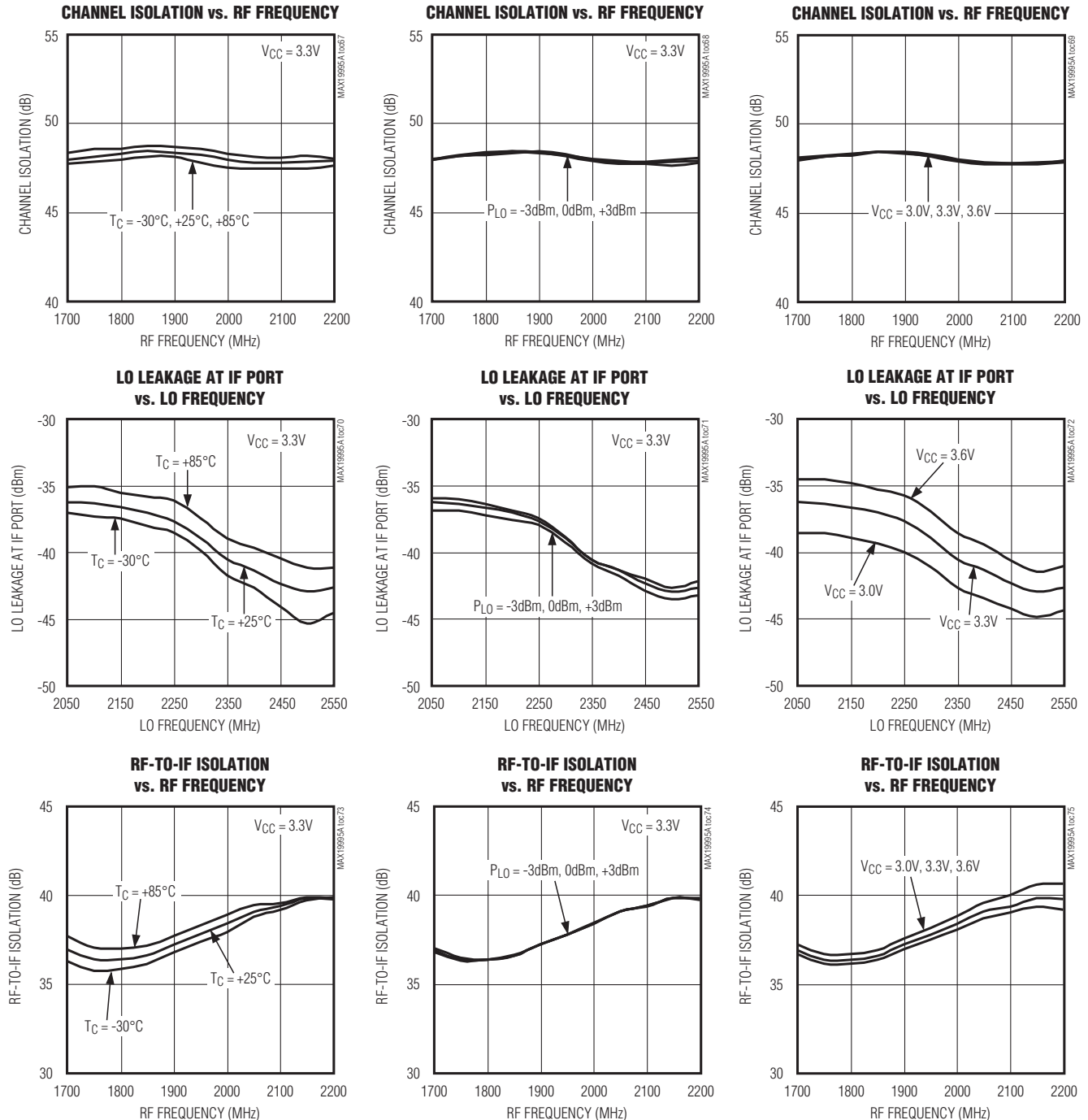

# Dual, SiGe, High-Linearity, 1700MHz to 2200MHz Downconversion Mixer with LO Buffer/Switch

## Typical Operating Characteristics

(Typical Application Circuit,  $R1 = R4 = 909\Omega$ ,  $R2 = R5 = 1k\Omega$ ,  $V_{CC} = 3.3V$ ,  $PRF = -5dBm$ ,  $P_{LO} = 0dBm$ ,  $f_{RF} = 1850MHz$ ,  $f_{LO} = 2200MHz$ ,  $f_I = 350MHz$ ,  $T_C = +25^\circ C$ , unless otherwise noted.)

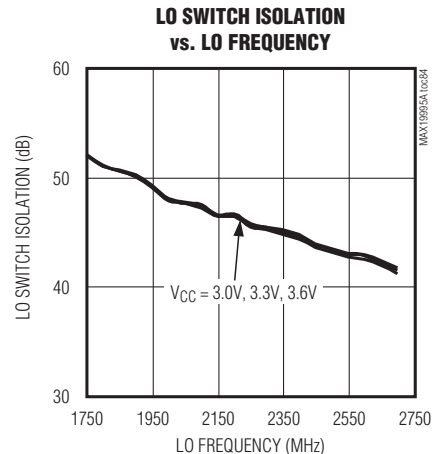
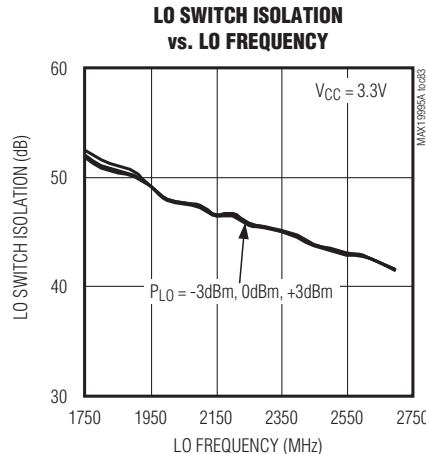
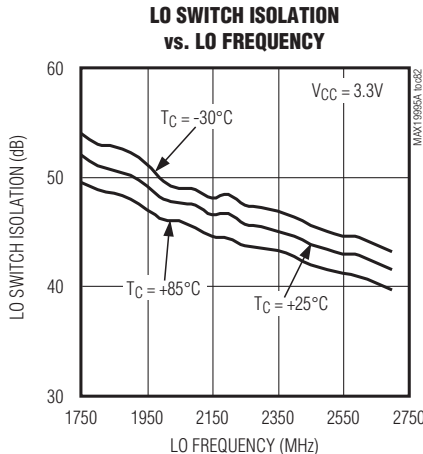
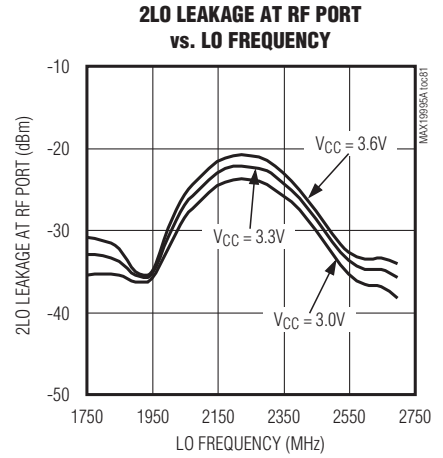
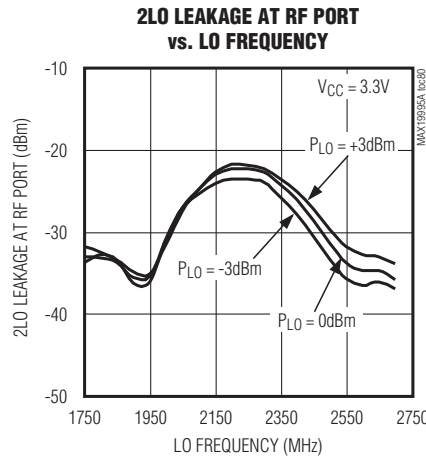
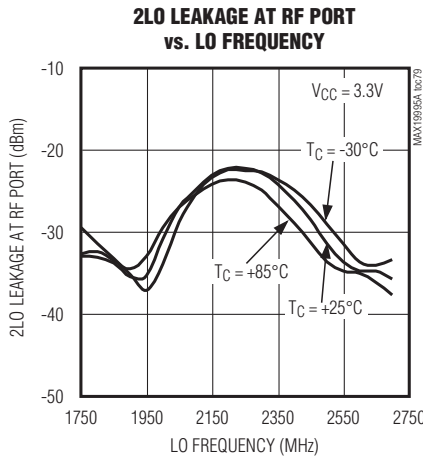
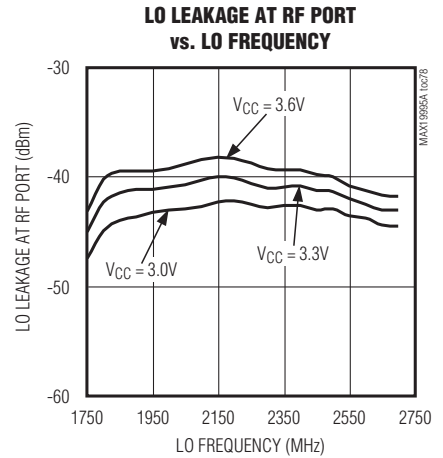
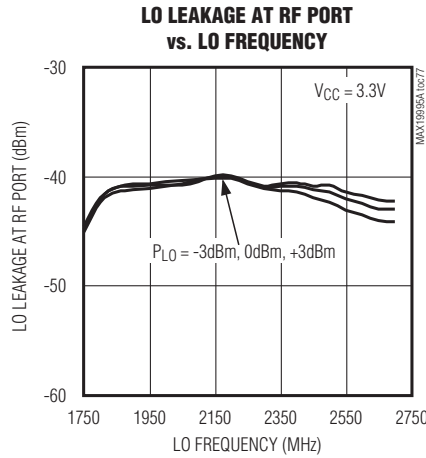
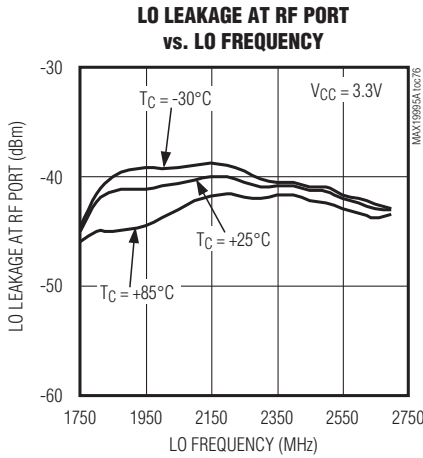



# Dual, SiGe, High-Linearity, 1700MHz to 2200MHz Downconversion Mixer with LO Buffer/Switch

## Typical Operating Characteristics (continued)

(Typical Application Circuit,  $R1 = R4 = 909\Omega$ ,  $R2 = R5 = 1k\Omega$ ,  $V_{CC} = 3.3V$ ,  $PRF = -5dBm$ ,  $P_{LO} = 0dBm$ ,  $f_{RF} = 1850MHz$ ,  $f_{LO} = 2200MHz$ ,  $f_{IF} = 350MHz$ ,  $T_C = +25^\circ C$ , unless otherwise noted.)

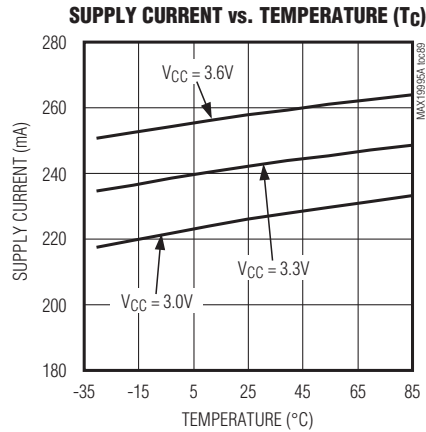
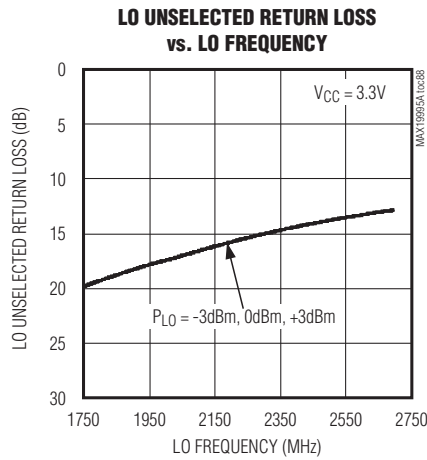
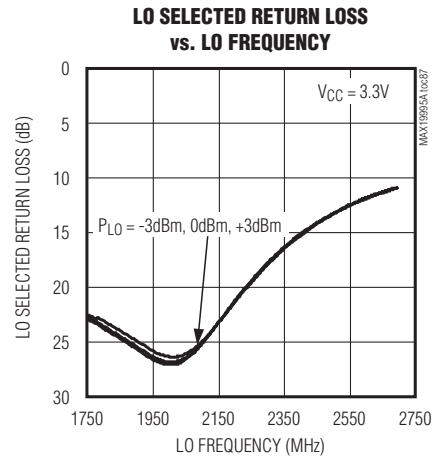
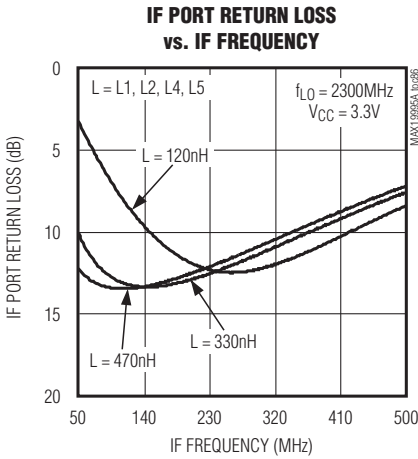
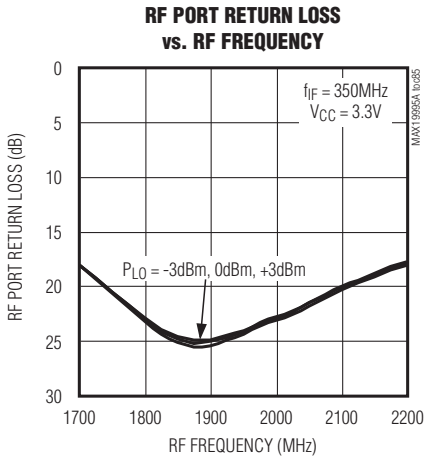

# Dual, SiGe, High-Linearity, 1700MHz to 2200MHz Downconversion Mixer with LO Buffer/Switch

MAX19995A

## Pin Description

PIN	NAME	FUNCTION
1	RFMAIN	Main Channel RF input. Internally matched to 50Ω. Requires an input DC-blocking capacitor.
2	TAPMAIN	Main Channel Balun Center Tap. Bypass to GND with 39pF and 0.033μF capacitors as close as possible to the pin with the smaller value capacitor closer to the part.
3, 5, 7, 12, 20, 22, 24, 25, 26, 34	GND	Ground
4, 6, 10, 16, 21, 30, 36	VCC	Power Supply. Bypass to GND with capacitors as shown in the <i>Typical Application Circuit</i> as close as possible to the pin.
8	TAPDIV	Diversity Channel Balun Center Tap. Bypass to GND with 39pF and 0.033μF capacitors as close as possible to the pin with the smaller value capacitor closer to the part.
9	RFDIV	Diversity Channel RF input. Internally matched to 50Ω. Requires an input DC-blocking capacitor.
11	IFD_SET	IF Diversity Amplifier Bias Control. Connect a resistor from this pin to ground to set the bias current for the diversity IF amplifier (see the <i>Typical Operating Characteristics</i> for typical performance vs. resistor value).
13, 14	IFD+, IFD-	Diversity Mixer Differential IF Output. Connect pullup inductors from each of these pins to VCC (see the <i>Typical Application Circuit</i> ).
15	IND_EXTD	Diversity External Inductor Connection. Connect this pin to ground. For improved RF-to-IF and LO-to-IF isolation, connect a low-ESR 10nH inductor from this pin to ground (see the <i>Typical Operating Characteristics</i> for typical performance vs. inductor value).
17	LO_ADJ_D	LO Diversity Amplifier Bias Control. Connect a resistor from this pin to ground to set the bias current for the diversity LO amplifier (see the <i>Typical Operating Characteristics</i> for typical performance vs. resistor value).
18, 28	N.C.	No Connection. Not internally connected.
19	LO1	Local Oscillator 1 Input. This input is internally matched to 50Ω. Requires an input DC-blocking capacitor.
23	LOSEL	Local Oscillator Select. Set this pin to high to select LO1. Set to low to select LO2.
27	LO2	Local Oscillator 2 Input. This input is internally matched to 50Ω. Requires an input DC-blocking capacitor.
29	LO_ADJ_M	LO Main Amplifier Bias Control. Connect a resistor from this pin to ground to set the bias current for the main LO amplifier (see the <i>Typical Operating Characteristics</i> for typical performance vs. resistor value).
31	IND_EXTM	Main External Inductor Connection. Connect this pin to ground. For improved RF-to-IF and LO-to-IF isolation, connect a low-ESR 10nH inductor from this pin to ground (see the <i>Typical Operating Characteristics</i> for typical performance vs. inductor value).
32, 33	IFM-, IFM+	Main Mixer Differential IF Output. Connect pullup inductors from each of these pins to VCC (see the <i>Typical Application Circuit</i> ).
35	IFM_SET	IF Main Amplifier Bias Control. Connect a resistor from this pin to ground to set the bias current for the main IF amplifier (see the <i>Typical Operating Characteristics</i> for typical performance vs. resistor value).
—	EP	Exposed Pad. Internally connected to GND. Solder this exposed pad to a PCB pad that uses multiple ground vias to provide heat transfer out of the device into the PCB ground planes. These multiple ground vias are also required to achieve the noted RF performance.

# Dual, SiGe, High-Linearity, 1700MHz to 2200MHz Downconversion Mixer with LO Buffer/Switch

MAX19995A

## Detailed Description

The MAX19995A is a dual-channel downconverter designed to provide up to 8.7dB of conversion gain, +24.8dBm input IP3, +13.5dBm 1dB input compression point, and a noise figure as low as 9.2dB.

In addition to its high-linearity performance, the MAX19995A achieves a high level of component integration. The device integrates two double-balanced mixers for two-channel downconversion. Both the main and diversity channels include a balun and matching circuitry to allow 50Ω single-ended interfaces to the RF ports and the two LO ports. An integrated single-pole/double-throw (SPDT) switch provides 50ns switching time between the two LO inputs, with 48dB of LO-to-LO isolation and -35dBm of LO leakage at the RF port. Furthermore, the integrated LO buffers provide a high drive level to each mixer core, reducing the LO drive required at the MAX19995A's inputs to a range of -3dBm to +3dBm. The IF ports for both channels incorporate differential outputs for downconversion, which are ideal for providing enhanced 2LO-2RF performance.

Specifications are guaranteed over broad frequency ranges to allow for use in UMTS/WCDMA, LTE/WiMAX, DCS1800/PCS1900 GSM/EDGE, TD-SCDMA, and cdma2000 base stations. The MAX19995A is specified to operate over an RF input range of 1700MHz to 2200MHz, an LO range of 1750MHz to 2700MHz, and an IF range of 50MHz to 500MHz. The external IF components set the lower frequency range (see the *Typical Operating Characteristics* for details). Operation beyond these ranges is possible; see the *Typical Operating Characteristics* for additional information. Although this device is optimized for high-side LO injection applications, it can operate in low-side LO injection modes as well. However, performance degrades as  $f_{LO}$  continues to decrease. For increased low-side LO performance, refer to the MAX19995 data sheet.

### RF Port and Balun

The RF input ports of both the main and diversity channels are internally matched to 50Ω, requiring no external matching components. A DC-blocking capacitor is required as the input is internally DC shorted to ground through the on-chip balun. The RF port input return loss is typically better than 16.5dB over the RF frequency range of 1700MHz to 2200MHz.

### LO Inputs, Buffer, and Balun

The MAX19995A is optimized for a 1750MHz to 2700MHz LO frequency range. As an added feature, the MAX19995A includes an internal LO SPDT switch for use in frequency-hopping applications. The switch selects one of the two single-ended LO ports, allowing the external oscillator to settle on a particular frequency before it is switched in. LO switching time is typically 50ns, which is more than adequate for typical GSM applications. If frequency hopping is not employed, simply set the switch to either of the LO inputs. The switch is controlled by a digital input (LOSEL), where logic-high selects LO1 and logic-low selects LO2. LO1 and LO2 inputs are internally matched to 50Ω, requiring only 39pF DC-blocking capacitors.

If LOSEL is connected directly to a logic source, then voltage **MUST** be applied to VCC before digital logic is applied to LOSEL to avoid damaging the part. Alternatively, a 1kΩ resistor can be placed in series at the LOSEL to limit the input current in applications where LOSEL is applied before VCC.

The main and diversity channels incorporate a two-stage LO buffer that allows for a wide-input power range for the LO drive. The on-chip low-loss baluns, along with LO buffers, drive the double-balanced mixers. All interfacing and matching components from the LO inputs to the IF outputs are integrated on-chip.

### High-Linearity Mixer

The core of the MAX19995A dual-channel downconverter consists of two double-balanced, high-performance passive mixers. Exceptional linearity is provided by the large LO swing from the on-chip LO buffers. When combined with the integrated IF amplifiers, the cascaded IIP3, 2LO-2RF rejection, and noise-figure performance are typically +24.8dBm, 64dBc, and 9.2dB, respectively.

### Differential IF

The MAX19995A has an IF frequency range of 50MHz to 500MHz, where the low-end frequency depends on the frequency response of the external IF components. Note that these differential ports are ideal for providing enhanced IIP2 performance. Single-ended IF applications require a 4:1 (impedance ratio) balun to transform the 200Ω differential IF impedance to a 50Ω single-ended system. After the balun, the return loss is typically 11.5dB. The user can use a differential IF amplifier on the mixer IF ports, but a DC block is required on both IFD+/IFD- and IFM+/IFM- ports to keep external DC from entering the IF ports of the mixer.

# Dual, SiGe, High-Linearity, 1700MHz to 2200MHz Downconversion Mixer with LO Buffer/Switch

## Applications Information

### Input and Output Matching

The RF and LO inputs are internally matched to 50 $\Omega$ . No matching components are required. The RF port input return loss is typically better than 16.5dB over the RF frequency range of 1700MHz to 2200MHz and return loss at the LO ports is typically better than 15dB over the entire LO range. RF and LO inputs require only DC-blocking capacitors for interfacing.

The IF output impedance is 200 $\Omega$  (differential). For evaluation, an external low-loss 4:1 (impedance ratio) balun transforms this impedance to a 50 $\Omega$  single-ended output (see the *Typical Application Circuit*).

### Reduced-Power Mode

Each channel of the MAX19995A has two pins (LO\_ADJ\_, IF\_SET) that allow external resistors to set the internal bias currents. Nominal values for these resistors are given in Table 1. Larger value resistors can be used to reduce power dissipation at the expense of some performance loss. If  $\pm 1\%$  resistors are not readily available, substitute with  $\pm 5\%$  resistors.

Significant reductions in power consumption can also be realized by operating the mixer with an optional supply voltage of 3.3V. Doing so reduces the overall power consumption by up to 54%. See the *3.3V Supply AC Electrical Characteristics* table and the relevant 3.3V curves in the *Typical Operating Characteristics* section.

### IND\_EXT\_ Inductors

For applications requiring optimum RF-to-IF and LO-to-IF isolation, connect low-ESR inductors from IND\_EXT\_ (pins 15 and 31) to ground. When improved isolation is not required, connect IND\_EXT\_ to ground using 0 $\Omega$  resistance. See the *Typical Operating Characteristics* to evaluate the isolation vs. inductor value tradeoff.

## Layout Considerations

A properly designed PCB is an essential part of any RF/microwave circuit. Keep RF signal lines as short as possible to reduce losses, radiation, and inductance. The load impedance presented to the mixer must be so that any capacitance from both IF- and IF+ to ground does not exceed several picofarads. For the best performance, route the ground pin traces directly to the exposed pad under the package. The PCB exposed pad **MUST** be connected to the ground plane of the PCB. It is suggested that multiple vias be used to connect this pad to the lower-level ground planes. This method provides a good RF/thermal-conduction path for the device. Solder the exposed pad on the bottom of the device package to the PCB. The MAX19995A evaluation kit can be used as a reference for board layout. Gerber files are available upon request at [www.maxim-ic.com](http://www.maxim-ic.com).

## Power-Supply Bypassing

Proper voltage-supply bypassing is essential for high-frequency circuit stability. Bypass each VCC pin and TAPMAIN/TAPDIV with the capacitors shown in the *Typical Application Circuit* (see Table 1 for component values). Place the TAPMAIN/TAPDIV bypass capacitors to ground within 100 mils of the pin.

## Exposed Pad RF/Thermal Considerations

The exposed pad (EP) of the MAX19995A's 36-pin thin QFN-EP package provides a low thermal-resistance path to the die. It is important that the PCB on which the MAX19995A is mounted be designed to conduct heat from the EP. In addition, provide the EP with a low-inductance path to electrical ground. The EP **MUST** be soldered to a ground plane on the PCB, either directly or through an array of plated via holes.

# Dual, SiGe, High-Linearity, 1700MHz to 2200MHz Downconversion Mixer with LO Buffer/Switch

Table 1. Component Values

DESIGNATION	QTY	DESCRIPTION	COMPONENT SUPPLIER
C1, C2, C7, C8, C14, C16	6	39pF microwave capacitors (0402)	Murata Electronics North America, Inc.
C3, C6	2	0.033μF microwave capacitors (0603)	Murata Electronics North America, Inc.
C4, C5	2	Not used	—
C9, C13, C15, C17, C18	5	0.01μF microwave capacitors (0402)	Murata Electronics North America, Inc.
C10, C11, C12, C19, C20, C21	6	150pF microwave capacitors (0603)	Murata Electronics North America, Inc.
L1, L2, L4, L5	4	120nH wire-wound high-Q inductors (0805)	Coilcraft, Inc.
L3, L6	2	10nH wire-wound high-Q inductors (0603). Smaller values can be used at the expense of some performance loss (see the <i>Typical Operating Characteristics</i> ).	Coilcraft, Inc.
R1, R4	2	681Ω ±1% resistors (0402). Used for <b>V<sub>CC</sub> = 5.0V</b> applications. Larger values can be used to reduce power at the expense of some performance loss (see the <i>Typical Operating Characteristics</i> ).	Digi-Key Corp.
		909Ω ±1% resistors (0402). Used for <b>V<sub>CC</sub> = 3.3V</b> applications.	
R2, R5	2	1.5kΩ ±1% resistors (0402). Used for <b>V<sub>CC</sub> = 5.0V</b> applications. Larger values can be used to reduce power at the expense of some performance loss (see the <i>Typical Operating Characteristics</i> ).	Digi-Key Corp.
		1kΩ ±1% resistors (0402). Used for <b>V<sub>CC</sub> = 3.3V</b> applications.	
R3, R6	2	0Ω resistors (1206)	Digi-Key Corp.
T1, T2	2	4:1 transformers (200:50) TC4-1W-17	Mini-Circuits
U1	1	MAX19995A IC (36 TQFN-EP)	Maxim Integrated Products, Inc.

**MAX19995A**

# Dual, SiGe, High-Linearity, 1700MHz to 2200MHz Downconversion Mixer with LO Buffer/Switch

MAX19995A

## Typical Application Circuit

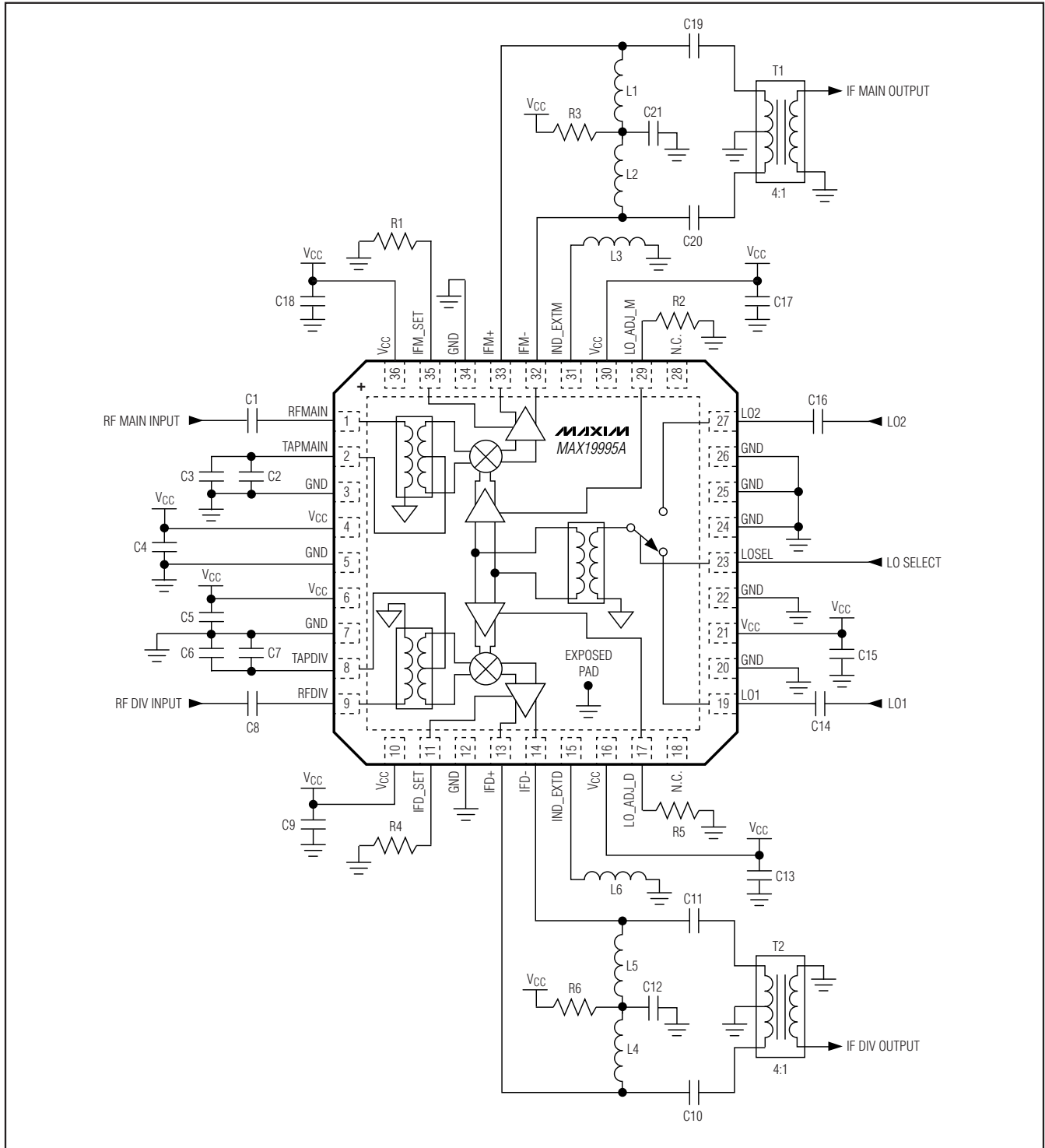

# Dual, SiGe, High-Linearity, 1700MHz to 2200MHz Downconversion Mixer with LO Buffer/Switch

## Pin Configuration/Functional Block Diagram

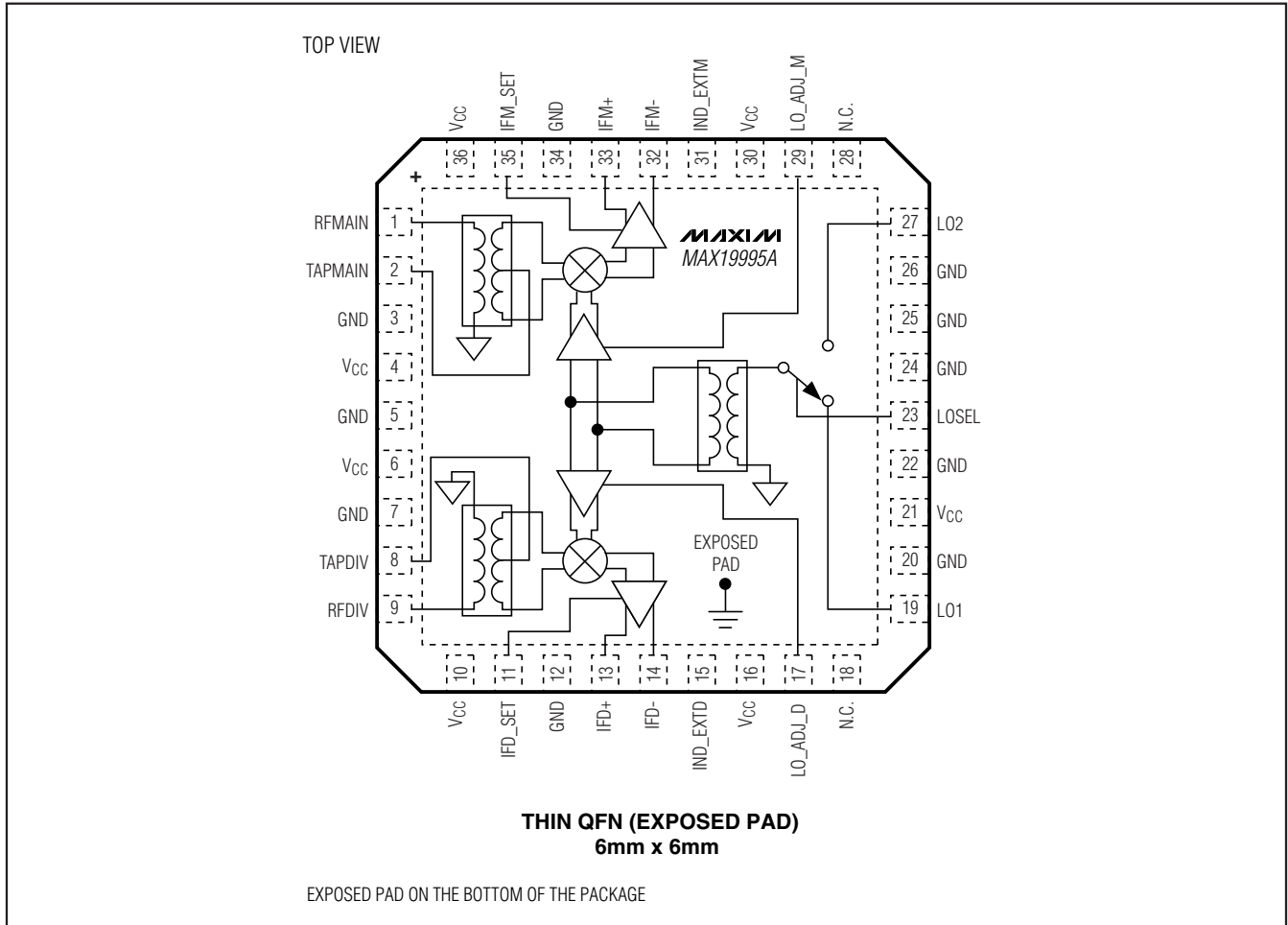

### Chip Information

PROCESS: SiGe BiCMOS

### Package Information

For the latest package outline information and land patterns, go to [www.maxim-ic.com/packages](http://www.maxim-ic.com/packages).

PACKAGE TYPE	PACKAGE CODE	DOCUMENT NO.
36 Thin QFN-EP	T3666+2	<a href="#">21-0141</a>

Maxim cannot assume responsibility for use of any circuitry other than circuitry entirely embodied in a Maxim product. No circuit patent licenses are implied. Maxim reserves the right to change the circuitry and specifications without notice at any time.

Maxim Integrated Products, 120 San Gabriel Drive, Sunnyvale, CA 94086 408-737-7600 23