



Dual, SiGe High-Linearity, 3000MHz to 4000MHz Downconversion Mixer with LO Buffer

MAX19999

General Description

The MAX19999 dual-channel downconverter provides 8.3dB of conversion gain, +24dBm input IP3, +11.4dBm 1dB input compression point, and a noise figure of 10.5dB for 3000MHz to 4000MHz WiMAX™ and LTE diversity receiver applications. With an optimized LO frequency range of 2650MHz to 3700MHz, this mixer is ideal for low-side LO injection architectures.

In addition to offering excellent linearity and noise performance, the MAX19999 also yields a high level of component integration. This device includes two double-balanced passive mixer cores, two LO buffers, and a pair of differential IF output amplifiers. Integrated on-chip baluns allow for single-ended RF and LO inputs.

The MAX19999 requires a nominal LO drive of 0dBm and a typical supply current of 388mA at VCC = +5.0V or 279mA at VCC = +3.3V.

The MAX19999 is pin compatible with the MAX19997A 1800MHz to 2900MHz mixer and pin similar with the MAX19985/MAX19985A and MAX19995/MAX19995A series of 700MHz to 2200MHz mixers, making this entire family of downconverters ideal for applications where a common PCB layout is used across multiple frequency bands.

The MAX19999 is available in a compact 6mm x 6mm, 36-pin thin QFN package with an exposed pad. Electrical performance is guaranteed over the extended temperature range, from TC = -40°C to +85°C.

Applications

- 3.5GHz WiMAX and LTE Base Stations
- Fixed Broadband Wireless Access
- Microwave Links
- Wireless Local Loop
- Private Mobile Radios
- Military Systems

Pin Configuration/Functional Diagram and Typical Application Circuit appear at end of data sheet.

Features

- ◆ 3000MHz to 4000MHz RF Frequency Range
- ◆ 2650MHz to 3700MHz LO Frequency Range
- ◆ 50MHz to 500MHz IF Frequency Range
- ◆ 8.3dB Conversion Gain
- ◆ +24dBm Input IP3
- ◆ 10.5dB Noise Figure
- ◆ +11.4dBm Input 1dB Compression Point
- ◆ 74dBc Typical 2 x 2 Spurious Rejection at PRF = -10dBm
- ◆ Dual Channels Ideal for Diversity Receiver Applications
- ◆ Integrated LO Buffer
- ◆ Integrated LO and RF Baluns for Single-Ended Inputs
- ◆ Low -3dBm to +3dBm LO Drive
- ◆ Pin Compatible with the MAX19997A 1800MHz to 2900MHz Mixer
- ◆ Pin Similar to the MAX9995/MAX9995A and MAX19995/MAX19995A 1700MHz to 2200MHz Mixers and the MAX9985/MAX9985A and MAX19985/MAX19985A 700MHz to 1000MHz Mixers
- ◆ 39dB Channel-to-Channel Isolation
- ◆ Single +5.0V or +3.3V Supply
- ◆ External Current-Setting Resistors Provide Option for Operating Device in Reduced-Power/Reduced-Performance Mode

Ordering Information

PART	TEMP RANGE	PIN-PACKAGE
MAX19999ETX+	-40°C to +85°C	36 Thin QFN-EP*
MAX19999ETX+T	-40°C to +85°C	36 Thin QFN-EP*

+Denotes a lead-free/RoHS-compliant package.

*EP = Exposed pad.

T = Tape and reel.

WiMAX is a trademark of WiMAX Forum.



Maxim Integrated Products 1

For pricing, delivery, and ordering information, please contact Maxim Direct at 1-888-629-4642 or visit Maxim's website at www.maxim-ic.com.

Dual, SiGe High-Linearity, 3000MHz to 4000MHz Downconversion Mixer with LO Buffer

MAX19999

ABSOLUTE MAXIMUM RATINGS

V _{CC} to GND	-0.3V to +5.5V	θ _{JA} (Notes 2, 3)	+38°C/W
RF ₋ , LO to GND	-0.3V to +0.3V	θ _{JC} (Note 3)	7.4°C/W
IFM ₋ , IFD ₋ , IFM _{SET} , IFD _{SET} , LO _{ADJ_M} , LO _{ADJ_D} to GND	-0.3V to (V _{CC} + 0.3V)	Operating Case Temperature Range (Note 4)	T _C = -40°C to +85°C
RF ₋ , LO Input Power	+15dBm	Junction Temperature	+150°C
RF ₋ , LO Current (RF and LO are DC shorted to GND through balun)	50mA	Storage Temperature Range	-65°C to +150°C
Continuous Power Dissipation (Note 1)	8.7W	Lead Temperature (soldering, 10s)	+300°C

Note 1: Based on junction temperature $T_J = T_C + (\theta_{JC} \times V_{CC} \times I_{CC})$. This formula can be used when the temperature of the exposed pad is known while the device is soldered down to a PCB. See the *Applications Information* section for details. The junction temperature must not exceed +150°C.

Note 2: Junction temperature $T_J = T_A + (\theta_{JA} \times V_{CC} \times I_{CC})$. This formula can be used when the ambient temperature of the PCB is known. The junction temperature must not exceed +150°C.

Note 3: Package thermal resistances were obtained using the method described in JEDEC specification JESD51-7, using a four-layer board. For detailed information on package thermal considerations, refer to www.maxim-ic.com/thermal-tutorial.

Note 4: T_C is the temperature on the exposed pad of the package. T_A is the ambient temperature of the device and PCB.

Stresses beyond those listed under "Absolute Maximum Ratings" may cause permanent damage to the device. These are stress ratings only, and functional operation of the device at these or any other conditions beyond those indicated in the operational sections of the specifications is not implied. Exposure to absolute maximum rating conditions for extended periods may affect device reliability.

+5.0V SUPPLY DC ELECTRICAL CHARACTERISTICS

(*Typical Application Circuit*, no input RF or LO signals applied, V_{CC} = +4.75V to +5.25V, T_C = -40°C to +85°C. Typical values are at V_{CC} = +5.0V, T_C = +25°C, unless otherwise noted. R1 = R4 = 750Ω, R2 = R5 = 698Ω.)

PARAMETER	SYMBOL	CONDITIONS	MIN	TYP	MAX	UNITS
Supply Voltage	V _{CC}		4.75	5	5.25	V
Supply Current	I _{CC}	Total supply current		388	420	mA

+3.3V SUPPLY DC ELECTRICAL CHARACTERISTICS

(*Typical Application Circuit*, no input RF or LO signals applied, T_C = -40°C to +85°C. Typical values are at V_{CC} = +3.3V, T_C = +25°C, unless otherwise noted. R1, R4 = 1.1kΩ; R2, R5 = 845Ω.) (Note 5)

PARAMETER	SYMBOL	CONDITIONS	MIN	TYP	MAX	UNITS
Supply Voltage	V _{CC}	(Note 6)	3	3.3	3.6	V
Supply Current	I _{CC}	Total supply current		279		mA

RECOMMENDED AC OPERATING CONDITIONS

PARAMETER	SYMBOL	CONDITIONS	MIN	TYP	MAX	UNITS
RF Frequency	f _{RF}	(Notes 5, 7)	3000		4000	MHz
LO Frequency	f _{LO}	(Notes 5, 7)	2650		3700	MHz
IF Frequency	f _{IF}	Using Mini-Circuits TC4-1W-17 4:1 transformer as defined in the <i>Typical Application Circuit</i> , IF matching components affect the IF frequency range (Notes 5, 7)	100		500	MHz
		Using alternative Mini-Circuits TC4-1W-7A 4:1 transformer, IF matching components affect the IF frequency range (Notes 5, 7)	50		250	
LO Drive Level	P _{LO}	(Note 7)	-3		+3	dBm

Dual, SiGe High-Linearity, 3000MHz to 4000MHz Downconversion Mixer with LO Buffer

+5.0V SUPPLY AC ELECTRICAL CHARACTERISTICS

(Typical Application Circuit, $V_{CC} = +4.75V$ to $+5.25V$, RF and LO ports are driven from 50Ω sources, $P_{LO} = -3dBm$ to $+3dBm$, $P_{RF} = -5dBm$, $f_{RF} = 3200MHz$ to $3900MHz$, $f_{LO} = 2800MHz$ to $3600MHz$, $f_{IF} = 350MHz$, $f_{RF} > f_{LO}$, $T_C = -40^\circ C$ to $+85^\circ C$. Typical values are at $V_{CC} = +5.0V$, $P_{RF} = -5dBm$, $P_{LO} = 0dBm$, $f_{RF} = 3550MHz$, $f_{LO} = 3200MHz$, $f_{IF} = 350MHz$, $T_C = +25^\circ C$, unless otherwise noted.) (Note 8)

PARAMETER	SYMBOL	CONDITIONS	MIN	TYP	MAX	UNITS
Conversion Gain	G_C	$T_C = +25^\circ C$ (Notes 6, 9)	7.3	8.3	9.3	dB
Conversion Gain Flatness		$f_{RF} = 3200MHz$ to $3900MHz$, over any 100MHz band		0.15		dB
Gain Variation Over Temperature	T_{CCG}	$f_{RF} = 3200MHz$ to $3900MHz$, $T_C = -40^\circ C$ to $+85^\circ C$		-0.01		dB/ $^\circ C$
Input Compression Point	IP_{1dB}	(Notes 6, 9, 10)	9.8	11.4		dBm
Third-Order Input Intercept Point	IIP3	$f_{RF1} - f_{RF2} = 1MHz$, $P_{RF} = -5dBm$ per tone (Notes 6, 9)	21.6	24.3		dBm
		$f_{RF} = 3550MHz$, $f_{RF1} - f_{RF2} = 1MHz$, $P_{RF} = -5dBm$ per tone, $T_C = +25^\circ C$ (Notes 6, 9)	22	24.3		
Third-Order Input Intercept Point Variation Over Temperature		$f_{RF1} - f_{RF2} = 1MHz$, $T_C = -40^\circ C$ to $+85^\circ C$		± 0.3		dBm
Noise Figure	NF_{SSB}	Single sideband, no blockers present (Notes 5, 6)		10.5	13	dB
		Single sideband, no blockers present, $f_{RF} = 3500MHz$, $T_C = +25^\circ C$ (Notes 5, 6)		10.5	11.5	
Noise Figure Temperature Coefficient	T_{CNF}	Single sideband, no blockers present, $T_C = -40^\circ C$ to $+85^\circ C$		0.018		dB/ $^\circ C$
Noise Figure Under Blocking Conditions	NF_B	$f_{BLOCKER} = 3700MHz$, $P_{BLOCKER} = 8dBm$, $f_{RF} = 3450MHz$, $f_{LO} = 3100MHz$, $P_{LO} = 0dBm$, $V_{CC} = 5.0V$, $T_C = +25^\circ C$ (Notes 5, 6, 11)		21	25	dB
2RF-2LO Spurious Rejection	2×2	$f_{RF} = 3500MHz$, $f_{LO} = 3150MHz$, $f_{SPUR} = f_{LO} + 175MHz$, $T_C = +25^\circ C$	$P_{RF} = -10dBm$, (Notes 5, 6)	68	74	dBc
			$P_{RF} = -5dBm$, (Notes 6, 9)	63	69	
3RF-3LO Spurious Rejection	3×3	$f_{RF} = 3500MHz$, $f_{LO} = 3150MHz$, $f_{SPUR} = f_{LO} + 116.67MHz$, $T_C = +25^\circ C$	$P_{RF} = -10dBm$, (Notes 5, 6)	77	86	dBc
			$P_{RF} = -5dBm$, (Notes 6, 9)	67	76	
RF Input Return Loss		LO on and IF terminated into a matched impedance		15.4		dB
LO Input Return Loss		RF and IF terminated into a matched impedance		14		dB
IF Output Impedance	Z_{IF}	Nominal differential impedance at the IC's IF outputs		200		Ω

MAX19999

Dual, SiGe High-Linearity, 3000MHz to 4000MHz Downconversion Mixer with LO Buffer

MAX19999

+5.0V SUPPLY AC ELECTRICAL CHARACTERISTICS (continued)

(Typical Application Circuit, $V_{CC} = +4.75V$ to $+5.25V$, RF and LO ports are driven from 50Ω sources, $P_{LO} = -3dBm$ to $+3dBm$, $P_{RF} = -5dBm$, $f_{RF} = 3200MHz$ to $3900MHz$, $f_{LO} = 2800MHz$ to $3600MHz$, $f_{IF} = 350MHz$, $f_{RF} > f_{LO}$, $T_C = -40^\circ C$ to $+85^\circ C$. Typical values are at $V_{CC} = +5.0V$, $P_{RF} = -5dBm$, $P_{LO} = 0dBm$, $f_{RF} = 3550MHz$, $f_{LO} = 3200MHz$, $f_{IF} = 350MHz$, $T_C = +25^\circ C$, unless otherwise noted.) (Note 8)

PARAMETER	SYMBOL	CONDITIONS	MIN	TYP	MAX	UNITS
IF Output Return Loss		RF terminated into 50Ω , LO driven by a 50Ω source, IF transformed to 50Ω using external components shown in the <i>Typical Application Circuit</i>		18		dB
RF-to-IF Isolation				28		dB
LO Leakage at RF Port		(Notes 6, 9)		-31	-24	dBm
2LO Leakage at RF Port				-30		dBm
LO Leakage at IF Port				-23		dBm
Channel Isolation		RFMAIN (RFDIV) converted power measured at IFDIV (IFMAIN), relative to IFMAIN (IFDIV), all unused ports terminated to 50Ω (Notes 6, 9)	36	39		dB

+3.3V SUPPLY AC ELECTRICAL CHARACTERISTICS

(Typical Application Circuit, typical values are at $V_{CC} = +3.3V$, $P_{RF} = -5dBm$, $P_{LO} = 0dBm$, $f_{RF} = 3550MHz$, $f_{LO} = 3200MHz$, $f_{IF} = 350MHz$, $T_C = +25^\circ C$, unless otherwise noted.) (Note 8)

PARAMETER	SYMBOL	CONDITIONS	MIN	TYP	MAX	UNITS
Conversion Gain	G_C			8.0		dB
Conversion Gain Flatness		$f_{RF} = 3200MHz$ to $3900MHz$, over any $100MHz$ band		0.15		dB
Gain Variation Over Temperature	T_{CCG}	$f_{RF} = 3200MHz$ to $3900MHz$, $T_C = -40^\circ C$ to $+85^\circ C$		-0.01		dB/ $^\circ C$
Input Compression Point	IP_{1dB}			8.4		dBm
Third-Order Input Intercept Point	IIP_3	$f_{RF1} - f_{RF2} = 1MHz$, $P_{RF} = -5dBm$ per tone		20.3		dBm
Third-Order Input Intercept Variation Over Temperature		$f_{RF1} - f_{RF2} = 1MHz$, $T_C = -40^\circ C$ to $+85^\circ C$		± 0.3		dBm
Noise Figure	NF_{SSB}	Single sideband, no blockers present		10.5		dB
Noise Figure Temperature Coefficient	TC_{NF}	Single sideband, no blockers present, $T_C = -40^\circ C$ to $+85^\circ C$		0.018		dB/ $^\circ C$
2RF-2LO Spurious Rejection	2×2	$f_{SPUR} = f_{LO} + 175MHz$	$P_{RF} = -10dBm$	74		dBc
			$P_{RF} = -5dBm$	69		
3RF-3LO Spurious Rejection	3×3	$f_{SPUR} = f_{LO} + 116.67MHz$	$P_{RF} = -10dBm$	75		dBc
			$P_{RF} = -5dBm$	65		
RF Input Return Loss		LO on and IF terminated into a matched impedance		16		dB
LO Input Return Loss		RF and IF terminated into a matched impedance		15.5		dB

Dual, SiGe High-Linearity, 3000MHz to 4000MHz Downconversion Mixer with LO Buffer

+3.3V SUPPLY AC ELECTRICAL CHARACTERISTICS (continued)

(Typical Application Circuit, typical values are at $V_{CC} = +3.3V$, $P_{RF} = -5dBm$, $P_{LO} = 0dBm$, $f_{RF} = 3550MHz$, $f_{LO} = 3200MHz$, $f_{IF} = 350MHz$, $T_C = +25^{\circ}C$, unless otherwise noted.) (Note 8)

PARAMETER	SYMBOL	CONDITIONS	MIN	TYP	MAX	UNITS
IF Output Impedance	Z_{IF}	Nominal differential impedance at the IC's IF outputs		200		Ω
IF Output Return Loss		RF terminated into 50Ω , LO driven by a 50Ω source, IF transformed to 50Ω using external components shown in the <i>Typical Application Circuit</i>		19		dB
RF-to-IF Isolation				28		dB
LO Leakage at RF Port				-36		dBm
2LO Leakage at RF Port				-34		dBm
LO Leakage at IF Port				-27		dBm
Channel Isolation		RFMAIN (RFDIV) converted power measured at IFDIV (IFMAIN), relative to IFMAIN (IFDIV), all unused ports terminated to 50Ω		38.5		dB

Note 5: Not production tested.

Note 6: Guaranteed by design and characterization.

Note 7: Operation outside this range is possible, but with degraded performance of some parameters. See the *Typical Operating Characteristics* section.

Note 8: All limits reflect losses of external components, including a 0.9dB loss at $f_{IF} = 350MHz$ due to the 4:1 impedance transformer. Output measurements were taken at IF outputs of the *Typical Application Circuit*.

Note 9: 100% production tested for functional performance.

Note 10: Maximum reliable continuous input power applied to the RF or IF port of this device is +12dBm from a 50Ω source.

Note 11: Measured with external LO source noise filtered so the noise floor is -174dBm/Hz. This specification reflects the effects of all SNR degradations in the mixer, including the LO noise as defined in Application Note 2021: *Specifications and Measurement of Local Oscillator Noise in Integrated Circuit Base Station Mixers*.

MAX19999

Dual, SiGe High-Linearity, 3000MHz to 4000MHz Downconversion Mixer with LO Buffer

Typical Operating Characteristics

(Typical Application Circuit, $V_{CC} = +5.0V$, LO is low-side injected for a 350MHz IF, $P_{LO} = 0dBm$, $P_{RF} = -5dBm$, $T_C = +25^\circ C$, unless otherwise noted.)

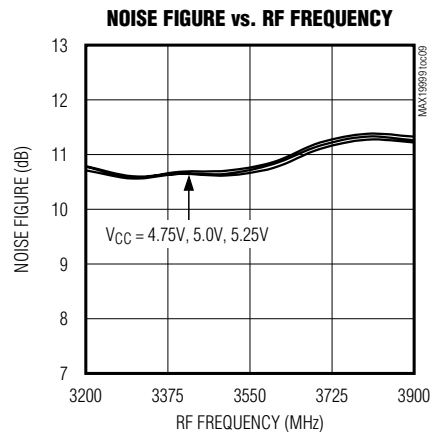
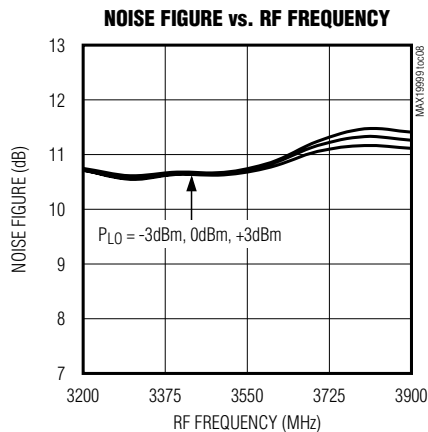
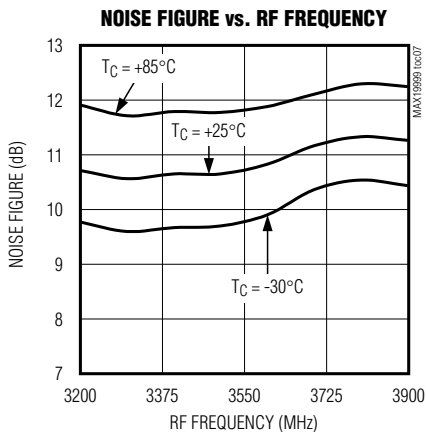
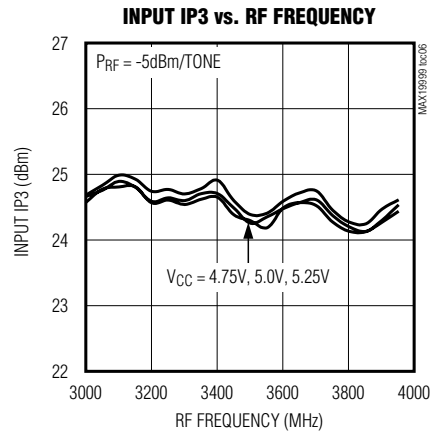
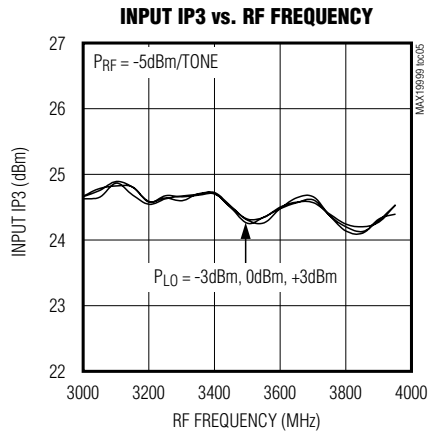
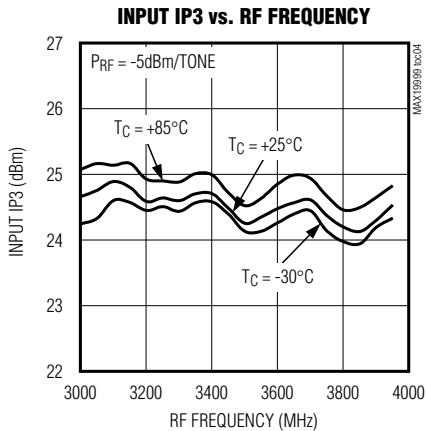
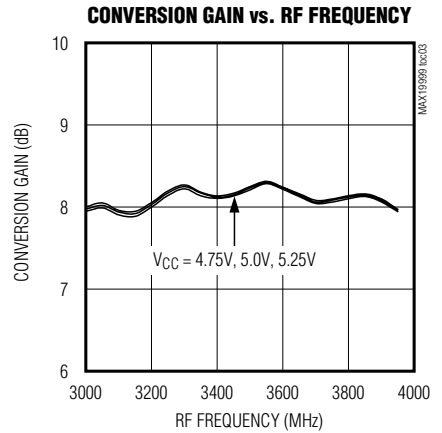
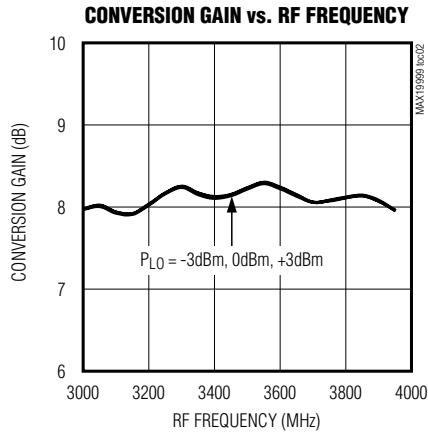
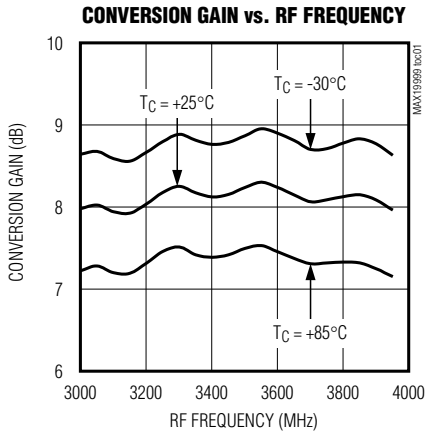

Dual, SiGe High-Linearity, 3000MHz to 4000MHz Downconversion Mixer with LO Buffer

Typical Operating Characteristics (continued)

(Typical Application Circuit, $V_{CC} = +5.0V$, LO is low-side injected for a 350MHz IF, $P_{LO} = 0dBm$, $P_{RF} = -5dBm$, $T_C = +25^\circ C$, unless otherwise noted.)

MAX19999

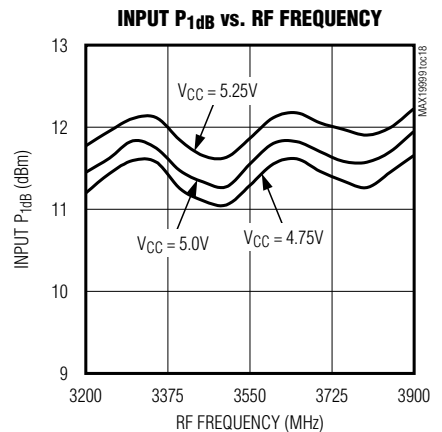
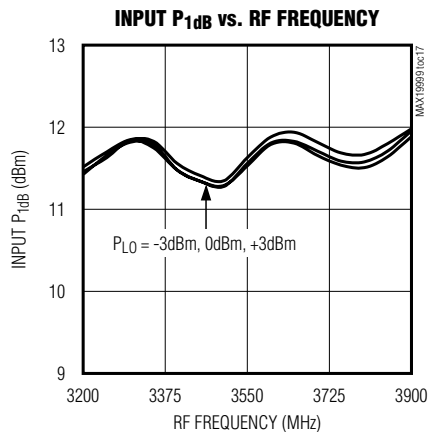
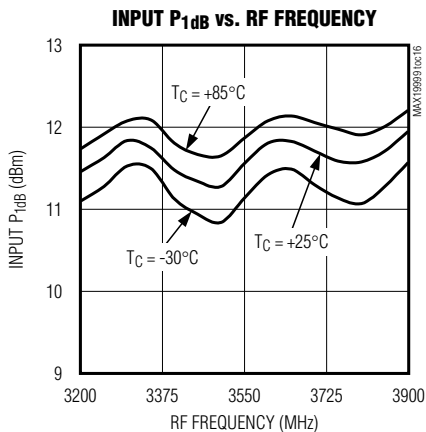
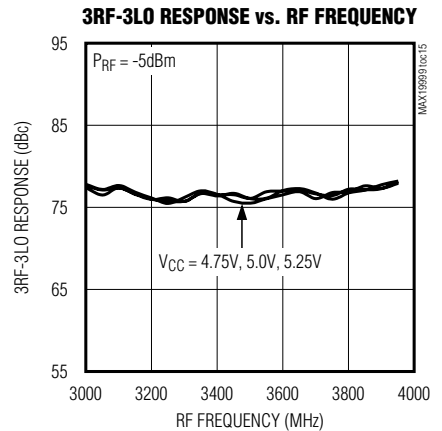
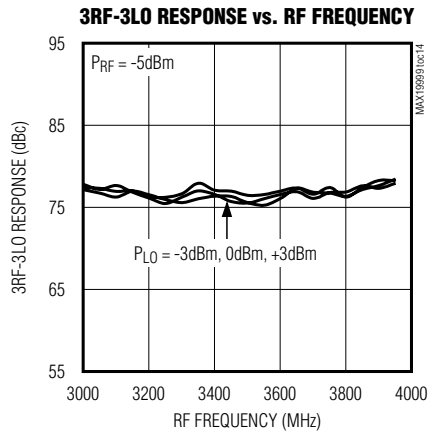
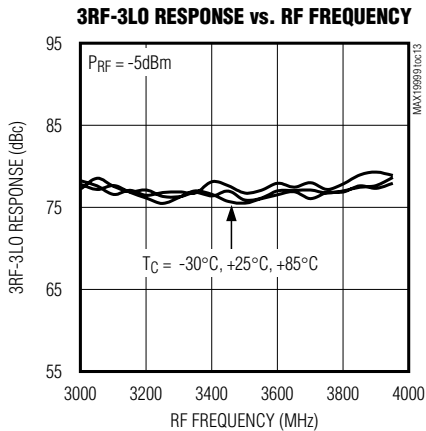
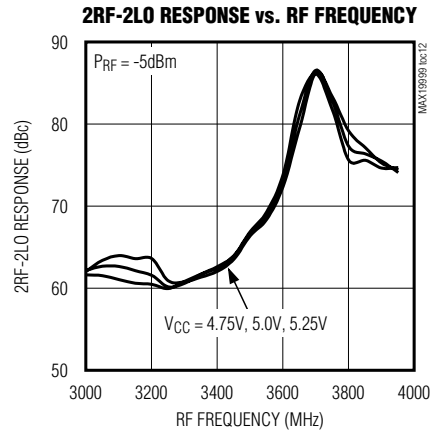
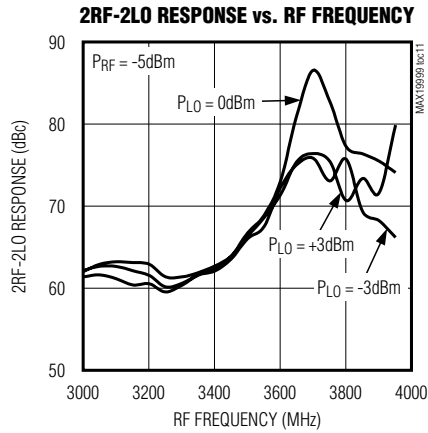
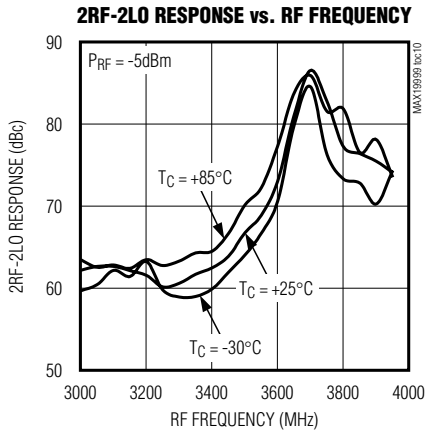

Dual, SiGe High-Linearity, 3000MHz to 4000MHz Downconversion Mixer with LO Buffer

Typical Operating Characteristics (continued)

(Typical Application Circuit, $V_{CC} = +5.0V$, LO is low-side injected for a 350MHz IF, $P_{LO} = 0dBm$, $P_{RF} = -5dBm$, $T_C = +25^\circ C$, unless otherwise noted.)

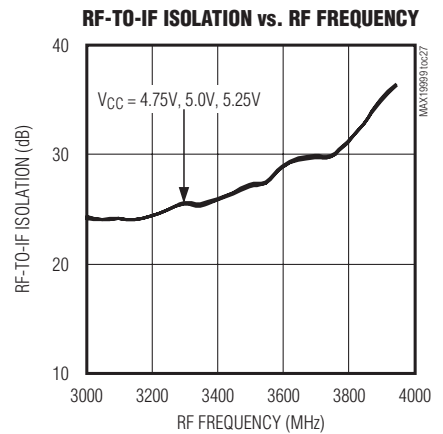
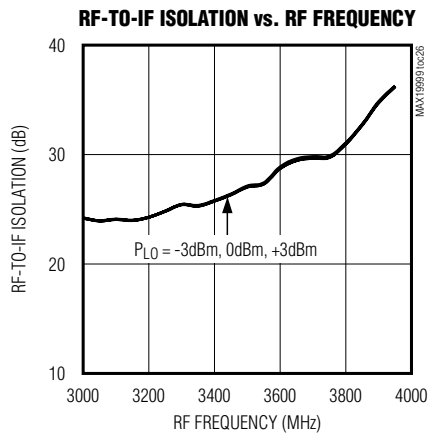
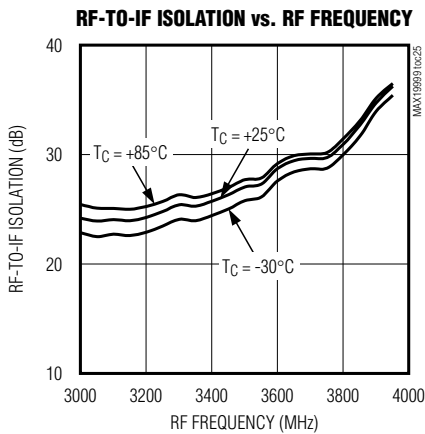
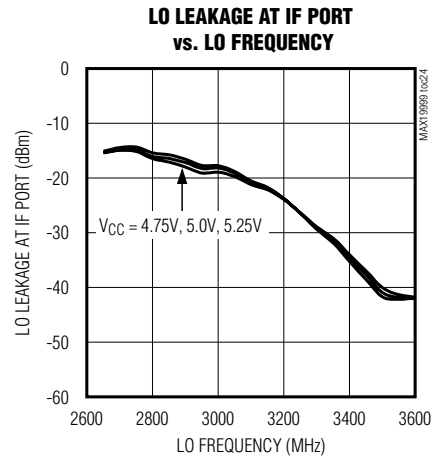
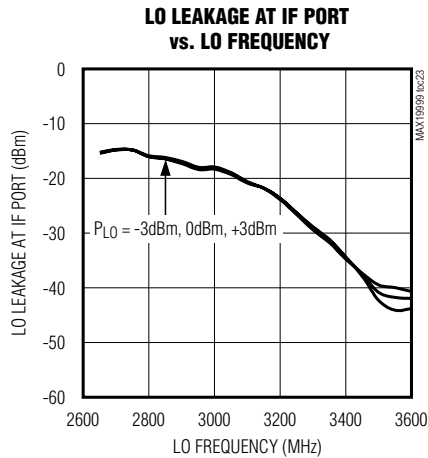
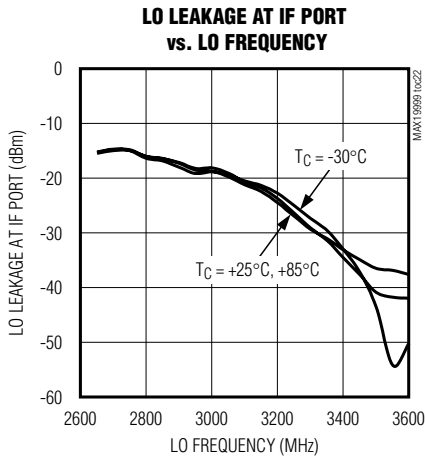
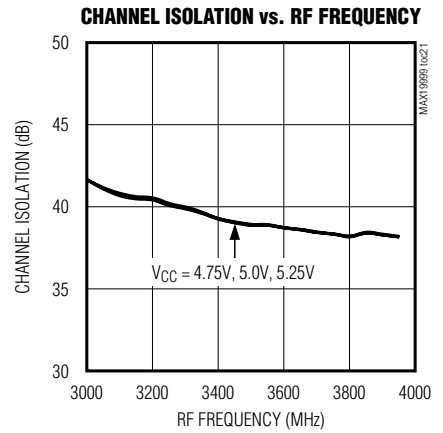
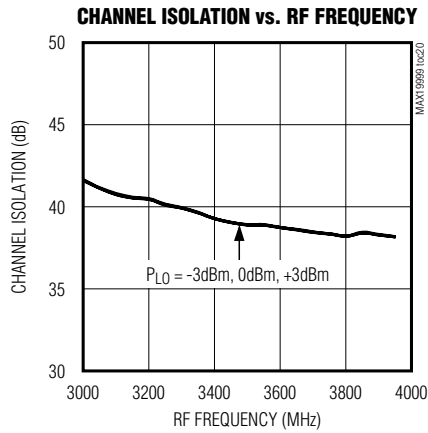
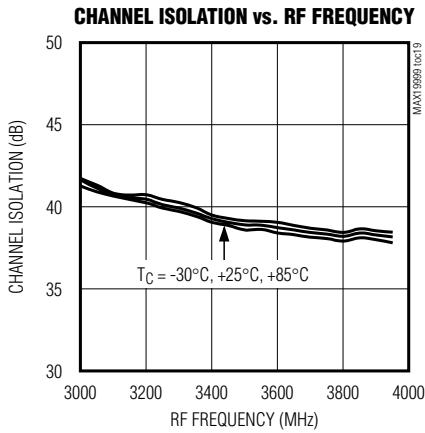

Dual, SiGe High-Linearity, 3000MHz to 4000MHz Downconversion Mixer with LO Buffer

Typical Operating Characteristics (continued)

(Typical Application Circuit, $V_{CC} = +5.0V$, LO is low-side injected for a 350MHz IF, $P_{LO} = 0dBm$, $P_{RF} = -5dBm$, $T_C = +25^\circ C$, unless otherwise noted.)

MAX19999

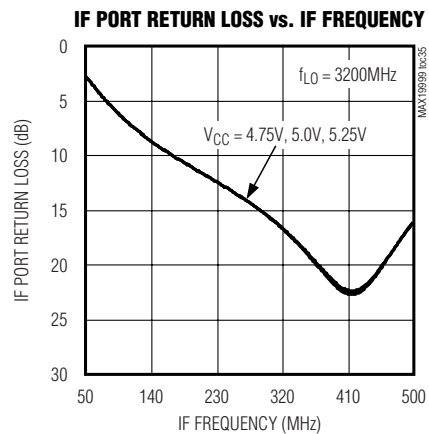
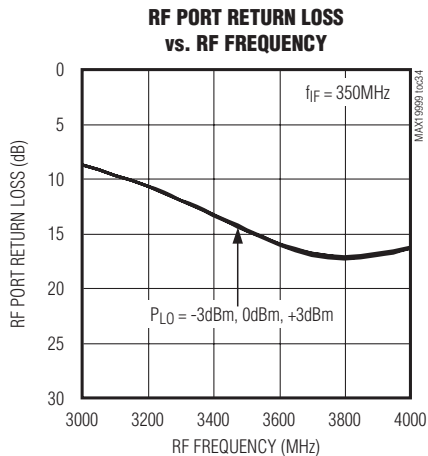
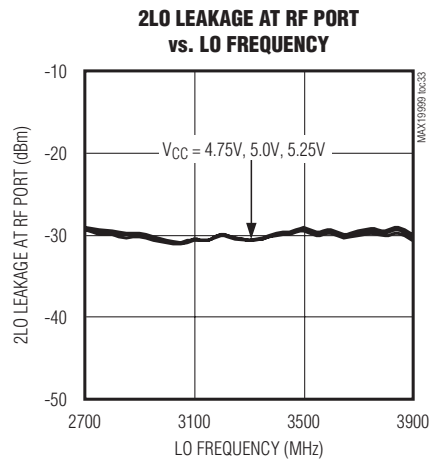
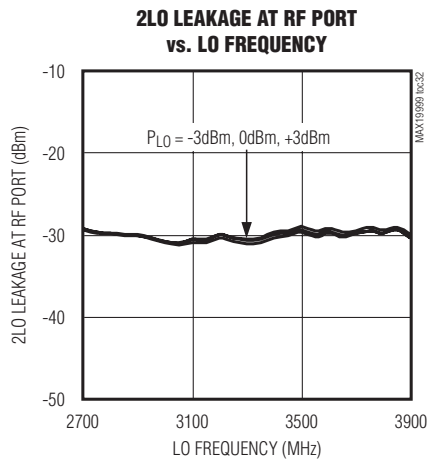
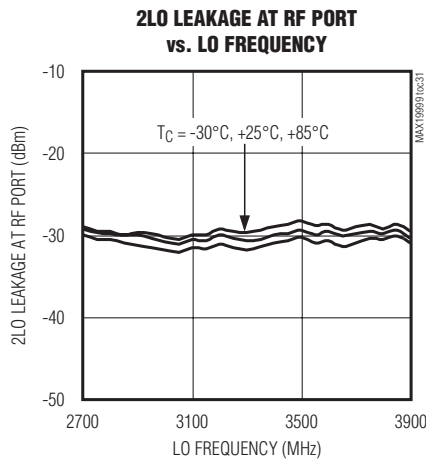
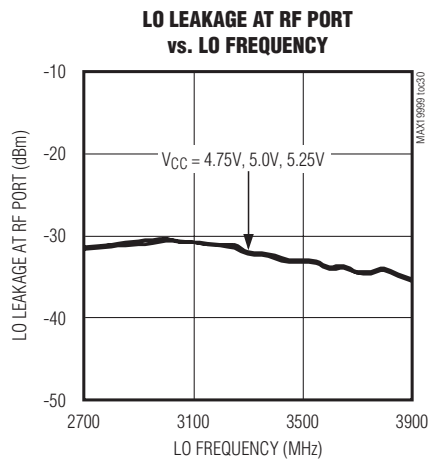
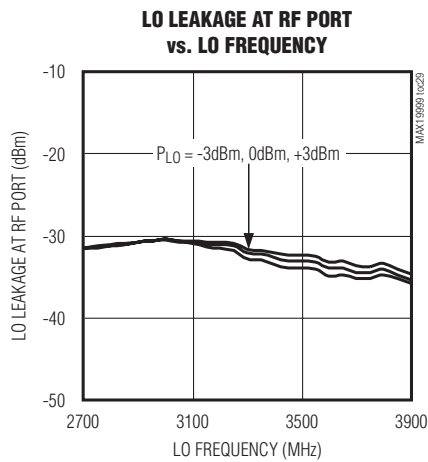
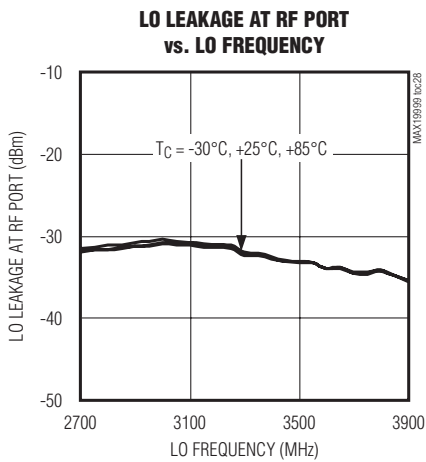

Dual, SiGe High-Linearity, 3000MHz to 4000MHz Downconversion Mixer with LO Buffer

Typical Operating Characteristics (continued)

(Typical Application Circuit, $V_{CC} = +5.0V$, LO is low-side injected for a 350MHz IF, $P_{LO} = 0dBm$, $P_{RF} = -5dBm$, $T_C = +25^\circ C$, unless otherwise noted.)

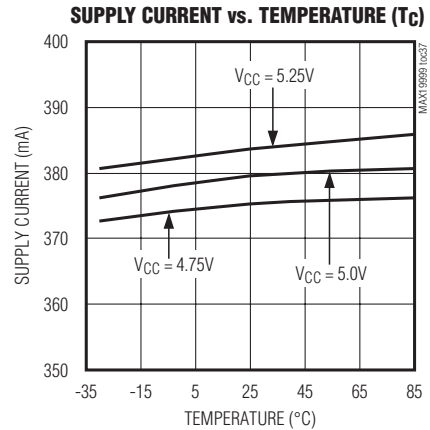
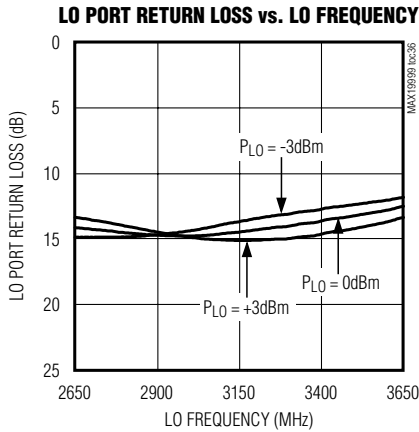

Typical Operating Characteristics (continued)

(Typical Application Circuit, $V_{CC} = +3.3V$, LO is low-side injected for a 350MHz IF, $P_{LO} = 0dBm$, $P_{RF} = -5dBm$, $T_C = +25^\circ C$, unless otherwise noted.)

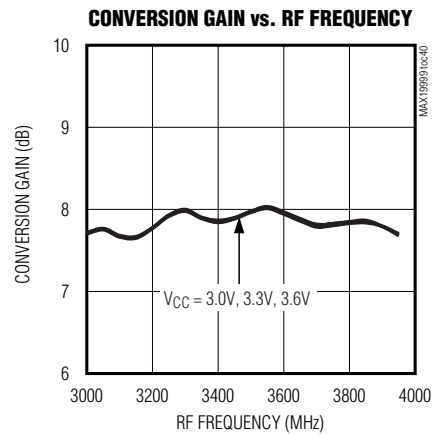
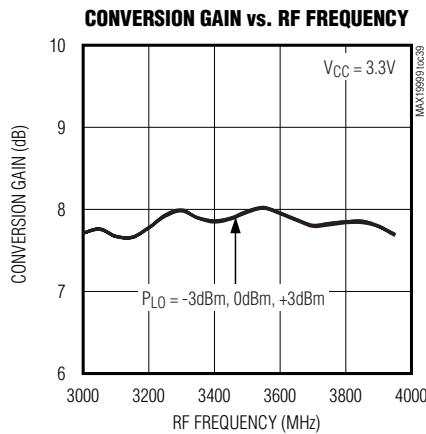
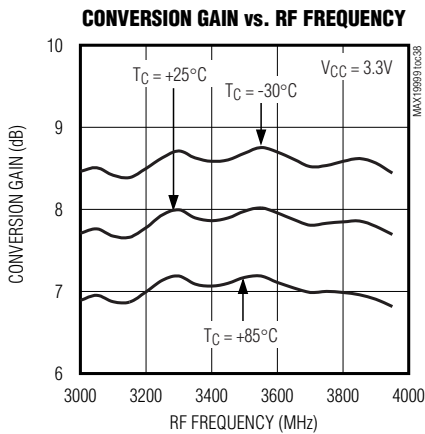

Dual, SiGe High-Linearity, 3000MHz to 4000MHz Downconversion Mixer with LO Buffer

Typical Operating Characteristics (continued)

(Typical Application Circuit, $V_{CC} = +3.3V$, LO is low-side injected for a 350MHz IF, $P_{LO} = 0dBm$, $P_{RF} = -5dBm$, $T_C = +25^\circ C$, unless otherwise noted.)

MAX19999

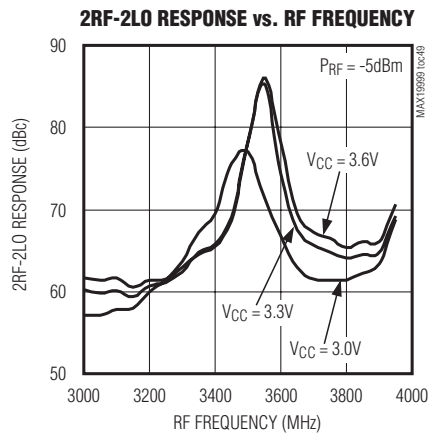
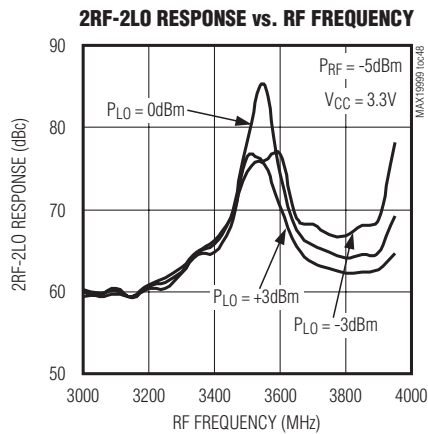
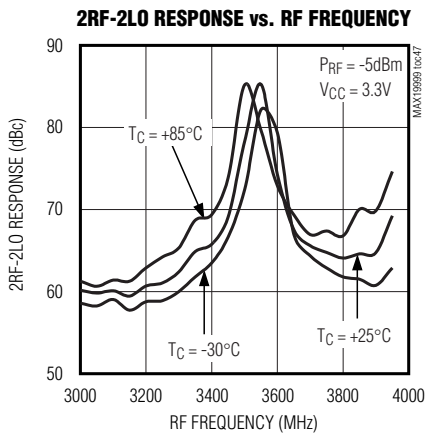
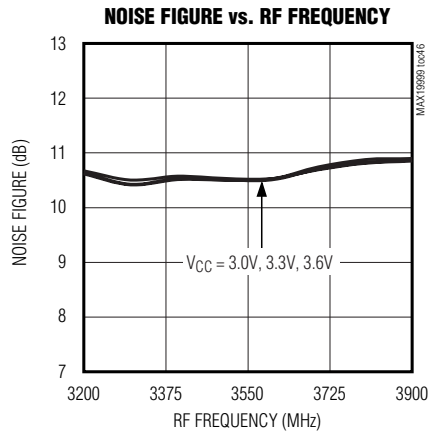
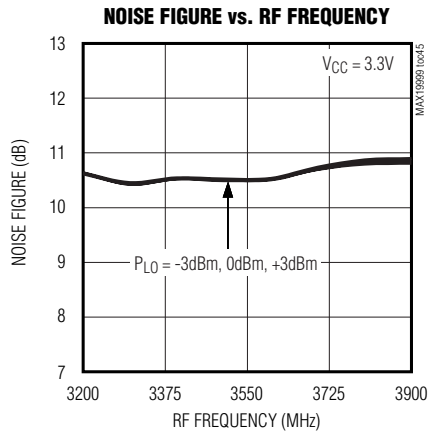
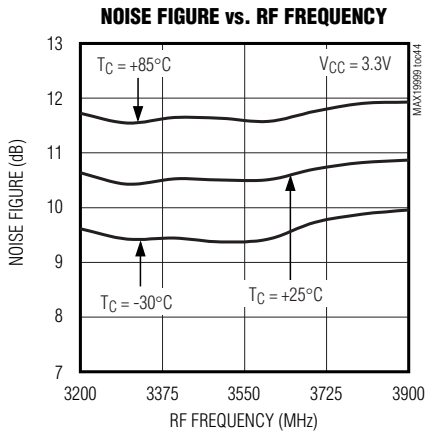
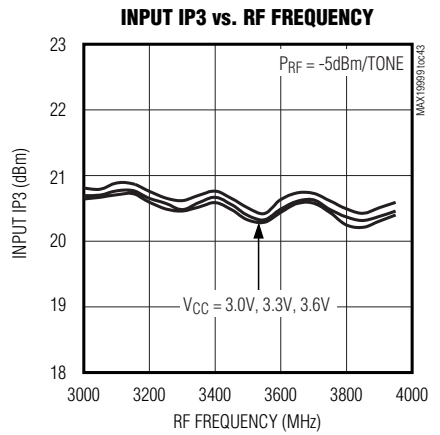
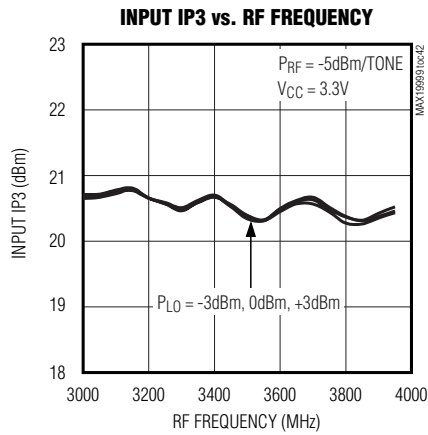
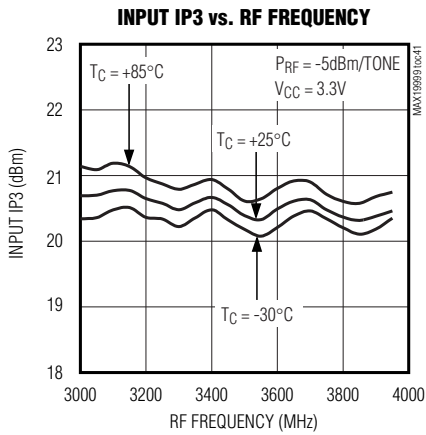

Dual, SiGe High-Linearity, 3000MHz to 4000MHz Downconversion Mixer with LO Buffer

Typical Operating Characteristics (continued)

(Typical Application Circuit, $V_{CC} = +3.3V$, LO is low-side injected for a 350MHz IF, $P_{LO} = 0dBm$, $P_{RF} = -5dBm$, $T_C = +25^\circ C$, unless otherwise noted.)

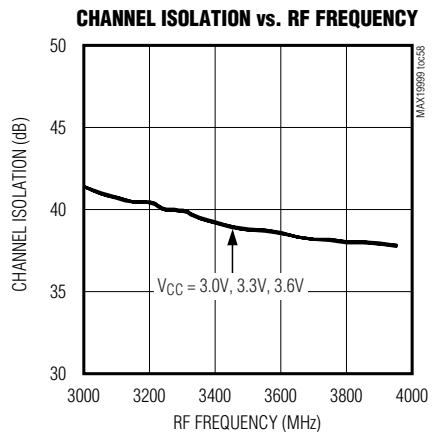
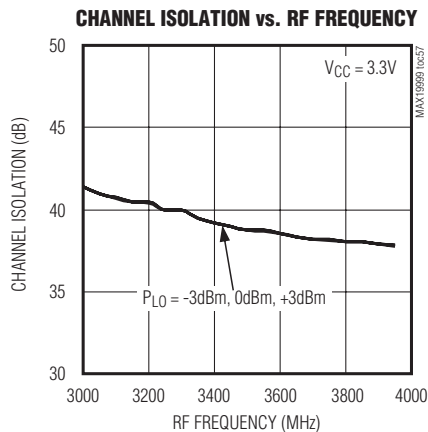
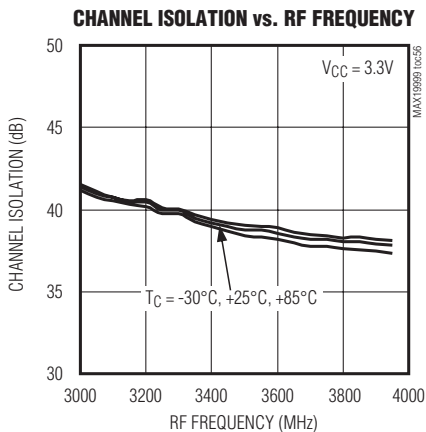
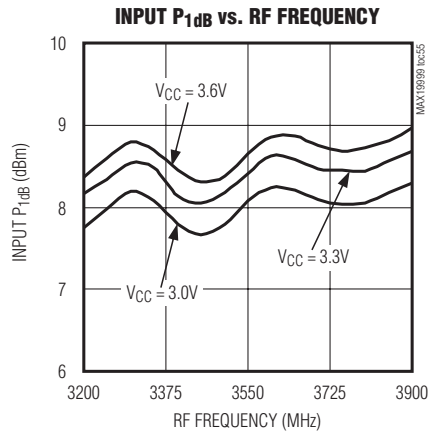
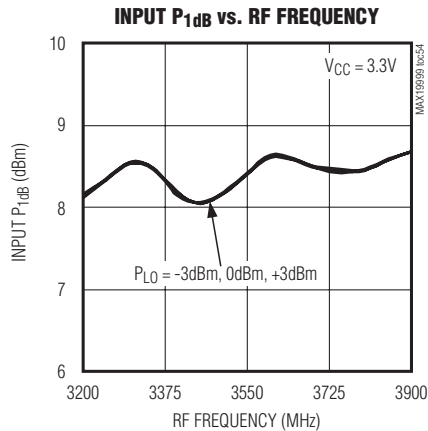
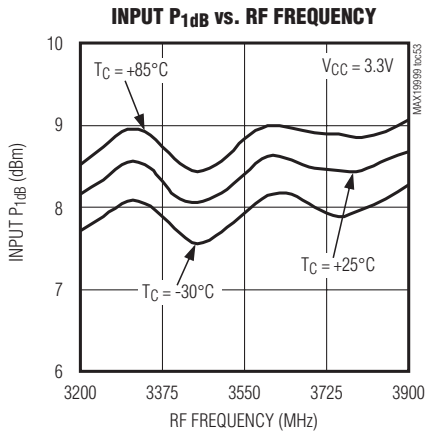
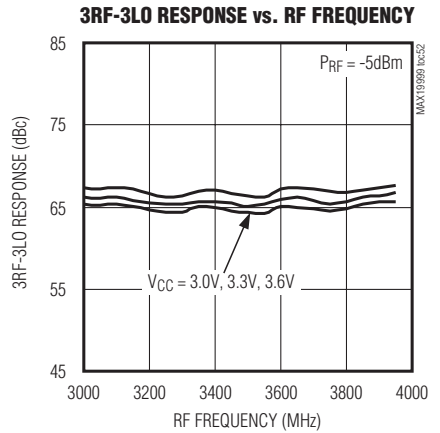
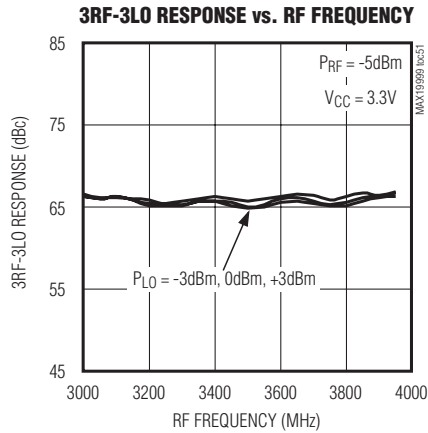
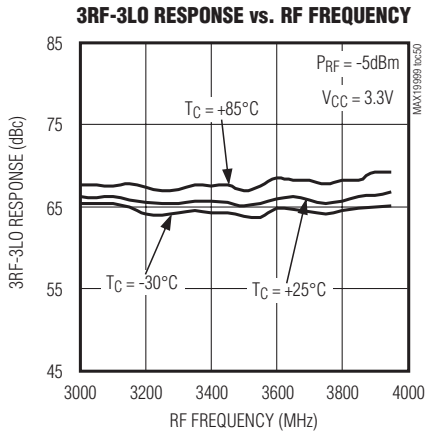

Dual, SiGe High-Linearity, 3000MHz to 4000MHz Downconversion Mixer with LO Buffer

Typical Operating Characteristics (continued)

(Typical Application Circuit, $V_{CC} = +3.3V$, LO is low-side injected for a 350MHz IF, $P_{LO} = 0dBm$, $P_{RF} = -5dBm$, $T_C = +25^\circ C$, unless otherwise noted.)

MAX19999

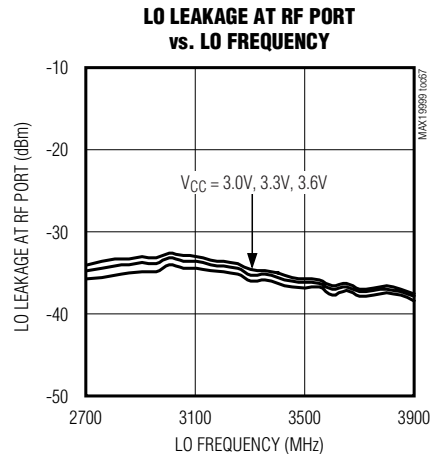
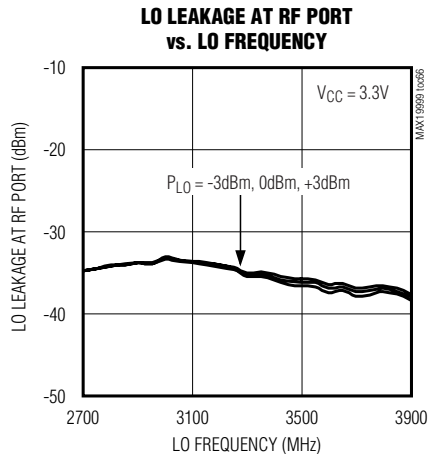
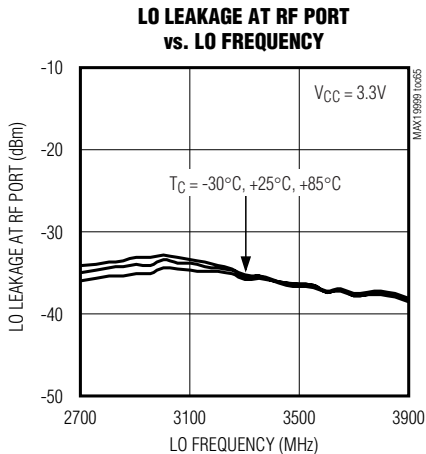
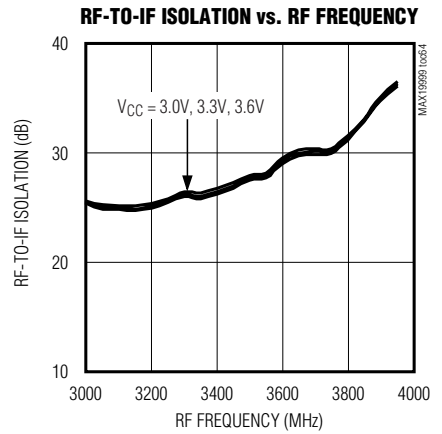
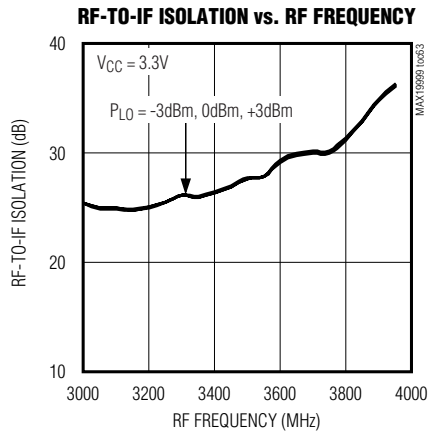
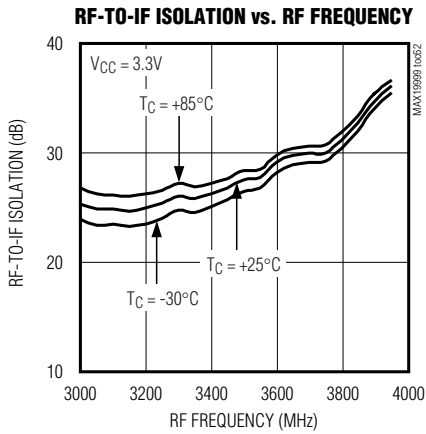
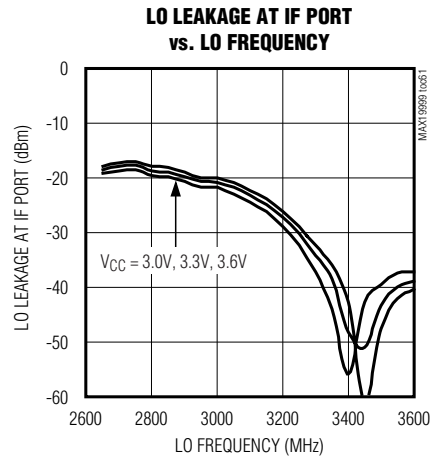
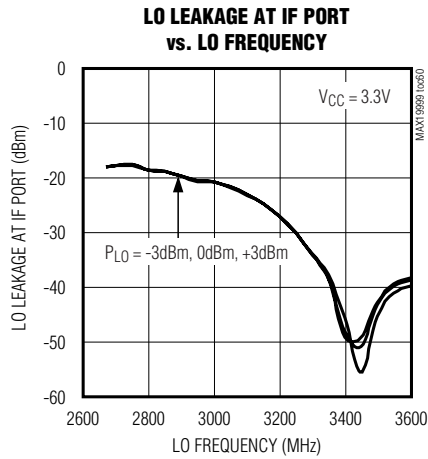
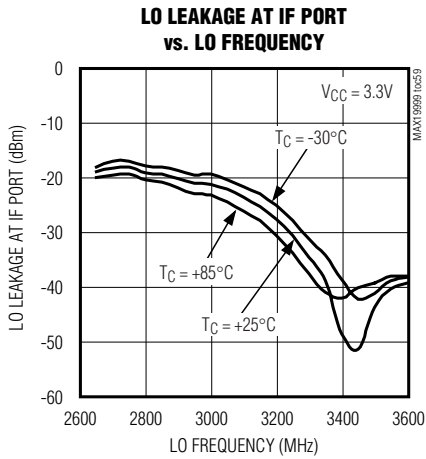

Dual, SiGe High-Linearity, 3000MHz to 4000MHz Downconversion Mixer with LO Buffer

Typical Operating Characteristics (continued)

(Typical Application Circuit, $V_{CC} = +3.3V$, LO is low-side injected for a 350MHz IF, $P_{LO} = 0dBm$, $P_{RF} = -5dBm$, $T_C = +25^\circ C$, unless otherwise noted.)

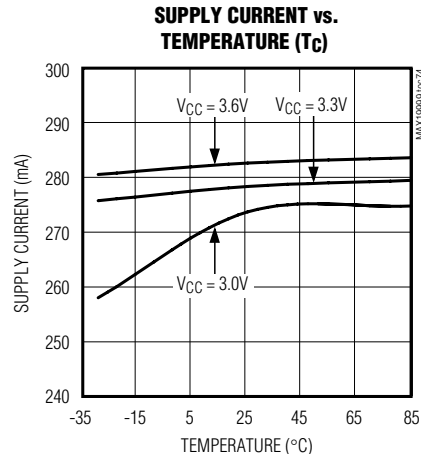
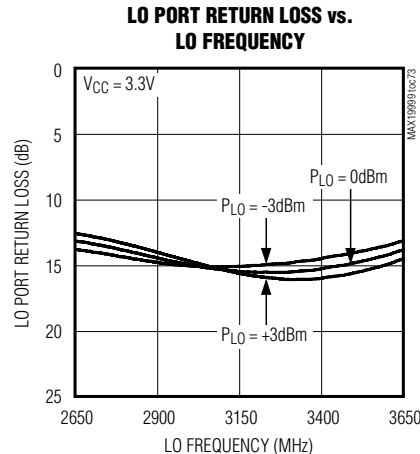
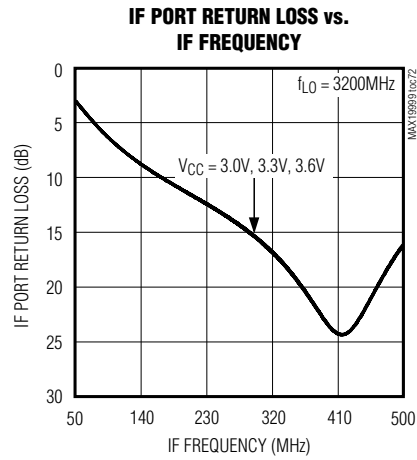
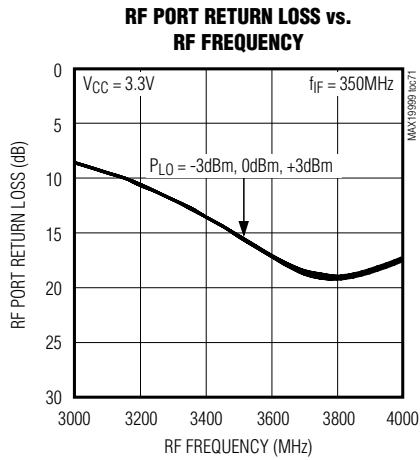
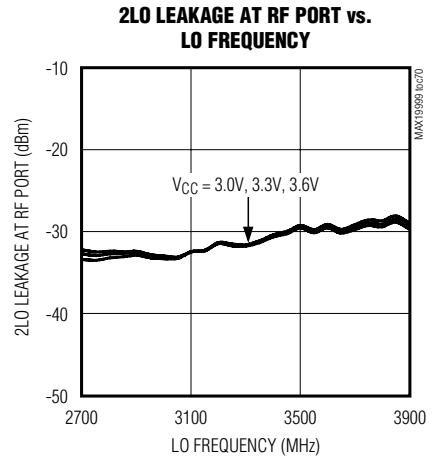
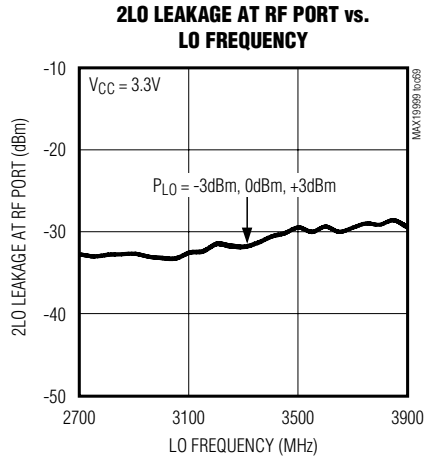
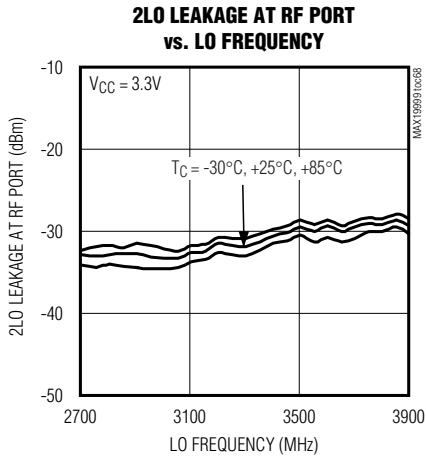

Dual, SiGe High-Linearity, 3000MHz to 4000MHz Downconversion Mixer with LO Buffer

Pin Description

PIN	NAME	FUNCTION
1	RFMAIN	Main Channel RF Input. Internally matched to 50Ω. Requires an input DC-blocking capacitor.
2, 5, 6, 8, 12, 15, 18, 23, 28, 31, 34	GND	Ground. Not internally connected. Ground these pins or leave unconnected.
3, 7, 20, 22, 24, 25, 26, 27	GND	Ground. Internally connected to the exposed pad (EP). Connect all ground pins and the exposed pad together.
4, 10, 16, 21, 30, 36	VCC	Power Supply. Connect bypass capacitors as close as possible to the pin (see the <i>Typical Application Circuit</i>).
9	RFDIV	Diversity Channel RF Input. This input is internally matched to 50Ω. Requires a DC-blocking capacitor.
11	IFD_SET	IF Diversity Amplifier Bias Control. Connect a resistor from this pin to ground to set the bias current for the diversity IF amplifier.
13, 14	IFD+, IFD-	Diversity Mixer Differential IF Output. Connect pullup inductors from each of these pins to VCC (see the <i>Typical Application Circuit</i>).
17	LO_ADJ_D	LO Diversity Amplifier Bias Control. Connect a resistor from this pin to ground to set the bias current for the diversity LO amplifier.
19	LO	Local Oscillator Input. This input is internally matched to 50Ω. Requires an input DC-blocking capacitor.
29	LO_ADJ_M	LO Main Amplifier Bias Control. Connect a resistor from this pin to ground to set the bias current for the main LO amplifier.
32, 33	IFM-, IFM+	Main Mixer Differential IF Output. Connect pullup inductors from each of these pins to VCC (see the <i>Typical Application Circuit</i>).
35	IFM_SET	IF Main Amplifier Bias Control. Connect a resistor from this pin to ground to set the bias current for the main IF amplifier.
—	EP	Exposed Pad. Internally connected to GND. Solder this exposed pad to a PCB pad that uses multiple ground vias to provide heat transfer out of the device into the PCB ground planes. These multiple via grounds are also required to achieve the noted RF performance

Detailed Description

The MAX19999 provides high linearity and low noise figure for a multitude of 3000MHz to 4000MHz WiMAX and LTE base-station applications. This device operates over an LO range of 2650MHz to 3700MHz and an IF range of 50MHz to 500MHz. Integrated baluns and matching circuitry allow 50Ω single-ended interfaces to the RF and LO ports. The integrated LO buffer provides a high drive level to the mixer core, reducing the LO drive required at the MAX19999's input to a range of -3dBm to +3dBm. The IF port incorporates a differential output, which is ideal for providing enhanced 2RF-2LO performance.

RF Input and Balun

The MAX19999's two RF inputs (RFMAIN and RFDIV) provide a 50Ω match when combined with a series DC-blocking capacitor. This DC-blocking capacitor is

required because the input is internally DC shorted to ground through each channel's on-chip balun. When using a 1.5pF DC-blocking capacitor, the RF port input return loss is typically 15dB over the RF frequency range of 3200MHz to 3900MHz.

LO Input, Buffer, and Balun

A two-stage internal LO buffer allows a wide input power range for the LO drive. All guaranteed specifications are for an LO signal power from -3dBm to +3dBm. The on-chip low-loss balun, along with an LO buffer, drives the double-balanced mixer. All interfacing and matching components from the LO input to the IF outputs are integrated on chip.

High-Linearity Mixer

The core of the MAX19999 is a pair of double-balanced, high-performance passive mixers. Exceptional

MAX19999

Dual, SiGe High-Linearity, 3000MHz to 4000MHz Downconversion Mixer with LO Buffer

linearity is provided by the large LO swing from the on-chip LO buffer. When combined with the integrated IF amplifiers, the cascaded IIP3, 2RF-2LO rejection, and NF performance is typically +24dBm, 74dBc, and 10.5dB, respectively, for low-side LO injection architectures covering the 3000MHz to 4000MHz RF band.

Differential IF Output Amplifier

The MAX19999 mixers have an IF frequency range of 50MHz to 500MHz. The differential, open-collector IF output ports require external pullup inductors to V_{CC} . These pullup inductors are also used to resonate out the parasitic shunt capacitance of the IC, PCB components, and PCB to provide an optimized IF match at the frequency of interest. Note that differential IF outputs are ideal for providing enhanced 2RF-2LO rejection performance. Single-ended IF applications require a 4:1 balun to transform the 200Ω differential output impedance to a 50Ω single-ended output. After the balun, the IF return loss is typically 18dB.

Applications Information

Input and Output Matching

The RF and LO inputs are internally matched to 50Ω . No matching components are required for RF frequencies ranging from 3000MHz to 4000MHz. RF and LO inputs require only DC-blocking capacitors for interfacing.

The IF output impedance is 200Ω (differential). For evaluation, an external low-loss 4:1 (impedance ratio) balun transforms this impedance down to a 50Ω single-ended output (see the *Typical Application Circuit*).

Reduced-Power Mode

Each channel of the MAX19999 has two pins (LO_ADJ, IF_SET) that allow external resistors to set the internal bias currents. Nominal values for these resistors are given in Table 1. Larger valued resistors can be used to reduce power dissipation at the expense of some performance loss. If $\pm 1\%$ resistors are not readily available, $\pm 5\%$ resistors can be substituted.

Significant reductions in power consumption can also be realized by operating the mixer with an optional supply voltage of 3.3V. Doing so reduces the overall power consumption by up to 53%. See the *+3.3V Supply AC Electrical Characteristics* table and the relevant *+3.3V* curves in the *Typical Operating Characteristics* section to evaluate the power vs. performance trade-offs.

Layout Considerations

A properly designed PCB is an essential part of any RF/microwave circuit. Keep RF signal lines as short as possible to reduce losses, radiation, and inductance. For the best performance, route the ground pin traces directly to the exposed pad under the package.

The PCB exposed pad **MUST** be connected to the ground plane of the PCB. It is suggested that multiple vias be used to connect this pad to the lower level ground planes. This method provides a good RF/thermal-conduction path for the device. Solder the exposed pad on the bottom of the device package to the PCB. The MAX19999 evaluation kit can be used as a reference for board layout. Gerber files are available upon request at www.maxim-ic.com.

Power-Supply Bypassing

Proper voltage-supply bypassing is essential for high-frequency circuit stability. Bypass each V_{CC} pin with the capacitors shown in the *Typical Application Circuit*.

Exposed Pad RF/Thermal Considerations

The exposed pad (EP) of the MAX19999's 36-pin thin QFN-EP package provides a low thermal-resistance path to the die. It is important that the PCB on which the MAX19999 is mounted be designed to conduct heat from the exposed pad. In addition, provide the exposed pad with a low-inductance path to electrical ground. The exposed pad **MUST** be soldered to a ground plane on the PCB, either directly or through an array of plated via holes.

Dual, SiGe High-Linearity, 3000MHz to 4000MHz Downconversion Mixer with LO Buffer

Table 1. Application Circuit Component Values

DESIGNATION	QTY	DESCRIPTION	SUPPLIER
C1, C8, C14	3	1.5pF microwave capacitors (0402)	Murata Electronics North America, Inc.
C4, C9, C13, C15, C17, C18	6	0.01μF microwave capacitors (0402)	Murata Electronics North America, Inc.
C10, C11, C12, C19, C20, C21	6	82pF microwave capacitors (0603)	Murata Electronics North America, Inc.
L1–L4	4	120nH wire-wound high-Q inductors* (0805)	Coilcraft, Inc.
R1, R4	2	750Ω ±1% resistor (0402). Use for V_{CC} = +5.0V applications. Larger values can be used to reduce power at the expense of some performance loss. See the <i>Typical Operating Characteristics</i> .	Digi-Key Corp.
		1.1kΩ ±1% resistor (0402). Use for V_{CC} = +3.3V applications. Larger values can be used to reduce power at the expense of some performance loss. See the <i>Typical Operating Characteristics</i> .	Digi-Key Corp.
R2, R5	2	698Ω ±1% resistor (0402). Use for V_{CC} = +5.0V applications. Larger values can be used to reduce power at the expense of some performance loss. See the <i>Typical Operating Characteristics</i> .	Digi-Key Corp.
		845Ω ±1% resistor (0402). Use for V_{CC} = +3.3V applications. Larger values can be used to reduce power at the expense of some performance loss. See the <i>Typical Operating Characteristics</i> .	Digi-Key Corp.
R3, R6	2	0Ω resistors (1206). These resistors can be increased in value to reduce power dissipation in the device but will reduce the compression point. Full P _{1dB} performance achieved using 0Ω.	Digi-Key Corp.
T1, T2	2	4:1 IF balun TC4-1W-17+	Mini-Circuits
U1	1	MAX19999 IC (36 TQFN-EP)	Maxim Integrated Products, Inc.

*Use 390nH (0805) inductors for an IF frequency of 200MHz. Contact the factory for details.

MAX19999

Dual, SiGe High-Linearity, 3000MHz to 4000MHz Downconversion Mixer with LO Buffer

MAX19999

Typical Application Circuit

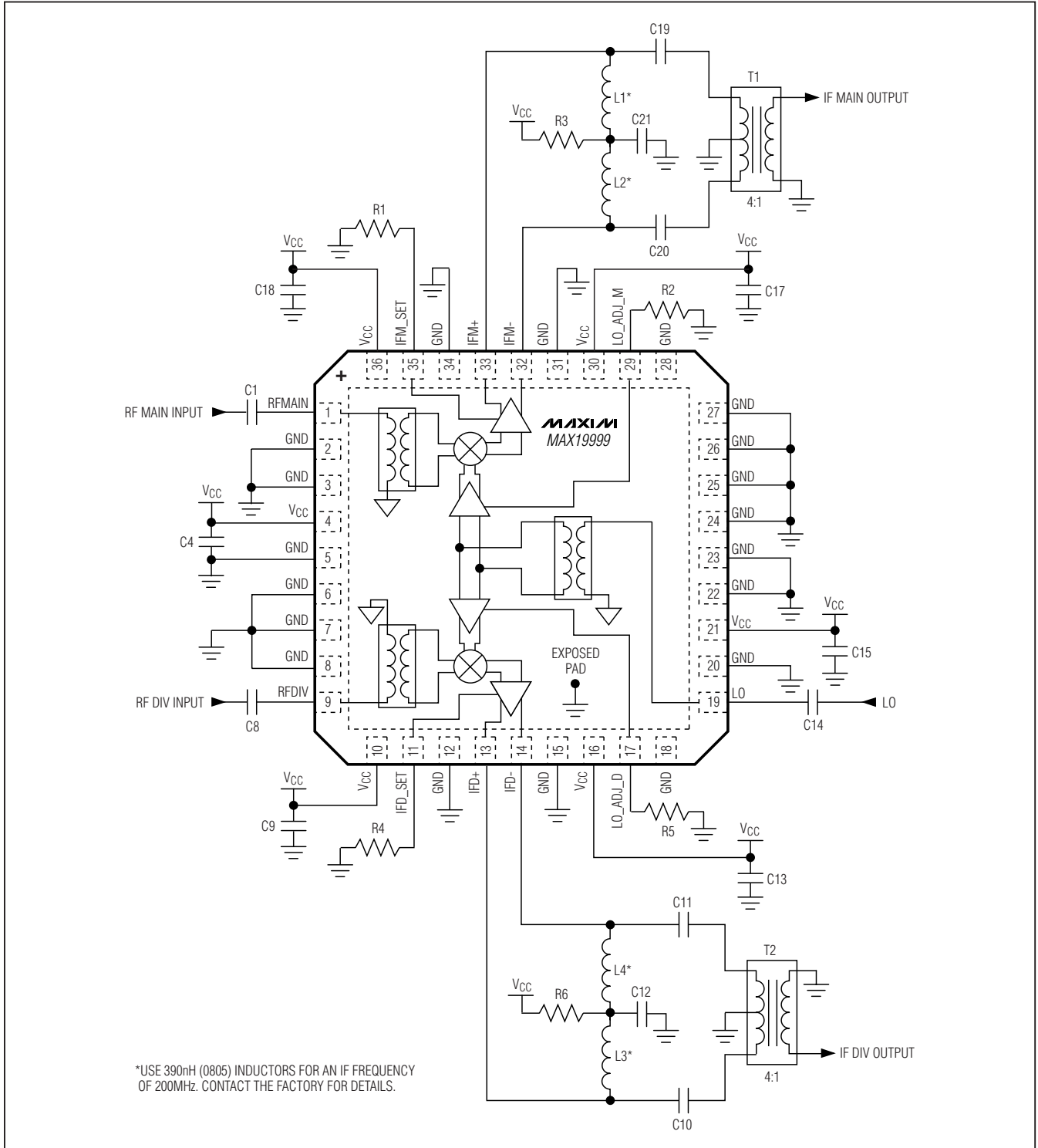

Dual, SiGe High-Linearity, 3000MHz to 4000MHz Downconversion Mixer with LO Buffer

Pin Configuration/Functional Diagram

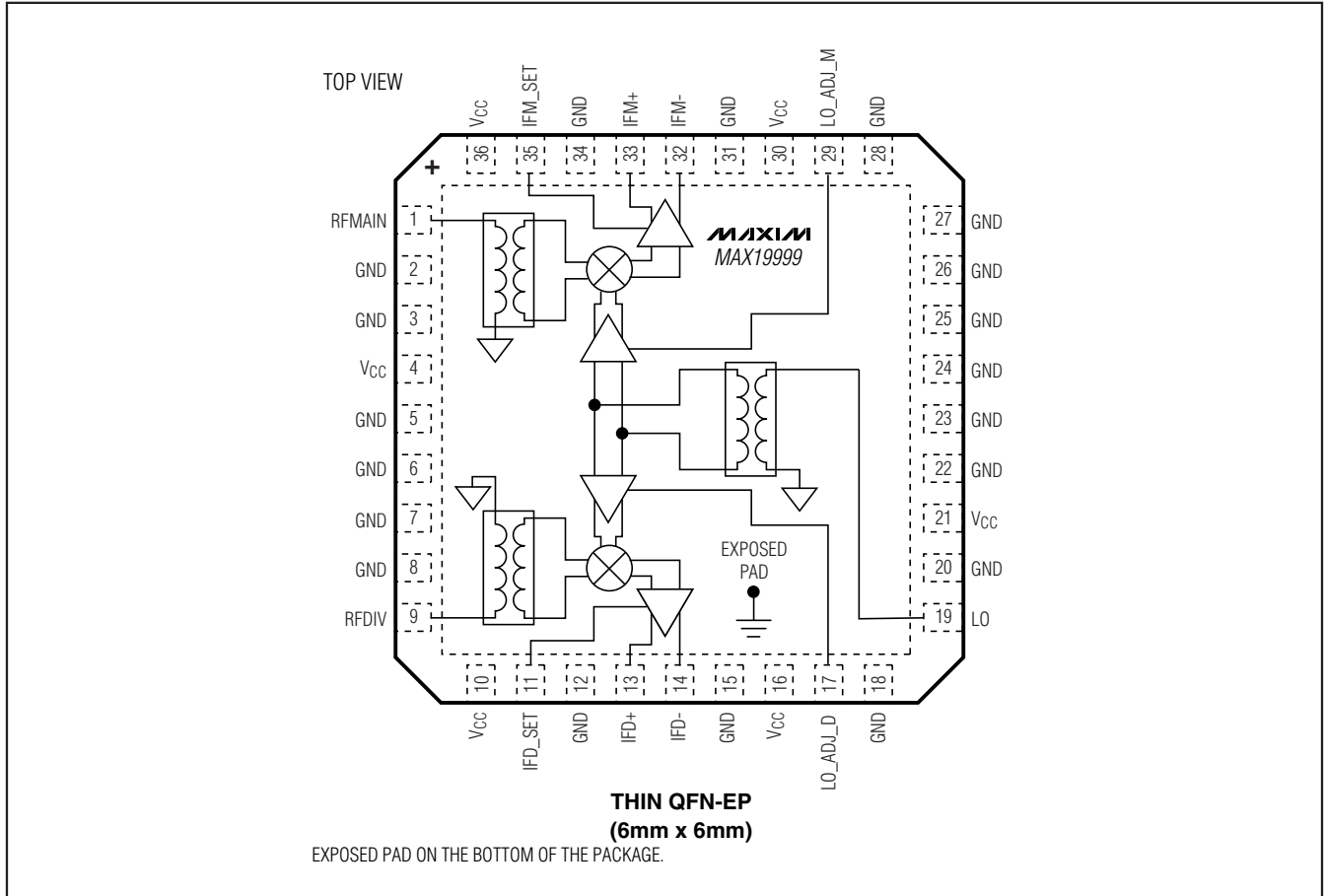

Chip Information

PROCESS: SiGe BiCMOS

Package Information

For the latest package outline information and land patterns, go to www.maxim-ic.com/packages.

PACKAGE TYPE	PACKAGE CODE	DOCUMENT NO.
36 Thin QFN-EP	T3666+2	21-0141

Maxim cannot assume responsibility for use of any circuitry other than circuitry entirely embodied in a Maxim product. No circuit patent licenses are implied. Maxim reserves the right to change the circuitry and specifications without notice at any time.

Maxim Integrated Products, 120 San Gabriel Drive, Sunnyvale, CA 94086 408-737-7600 19