

EVALUATION KIT
AVAILABLE

1300MHz to 2700MHz Variable-Gain Amplifier with Analog Gain Control

MAX2057

General Description

The MAX2057 general-purpose, high-performance variable-gain amplifier (VGA) is designed to operate in the 1300MHz to 2700MHz frequency range*. This device features 15.5dB of gain, 6dB of noise figure, and an output 1dB compression point of 23.8dBm. The MAX2057 also provides an exceptionally high OIP3 level of 37dBm, which is maintained over the entire attenuation range. In addition, the on-chip analog attenuators yield infinite control and high attenuation accuracy over selectable 21dB or 42dB control ranges. Each of these features makes the MAX2057 an ideal VGA for DCS/PCS, cdma2000™, W-CDMA, and PHS/PAS transmitter and power amplifier AGC circuits.

The MAX2057 is pin compatible with the MAX2056 800MHz to 1000MHz VGA, making this family of amplifiers ideal for applications where a common PC board layout is used for both frequency bands.

The MAX2057 operates from a single +5V supply and is available in a compact 36-pin thin QFN package (6mm x 6mm x 0.8mm) with an exposed pad. Electrical performance is guaranteed over the extended -40°C to +85°C temperature range.

Applications

DCS 1800/PCS 1900 2G and 2.5G EDGE Base-Station Transmitters and Power Amplifiers

cdmaOne™, cdma2000, Base-Station Transmitters and Power Amplifiers

WCDMA, LTE, TD-SCDMA, and TD-LTE Transmitters and Power Amplifiers

PHS/PAS Base-Station Transmitters and Power Amplifiers

Transmitter Gain Control

Receiver Gain Control

Broadband Systems

Automatic Test Equipment

Digital and Spread-Spectrum Communication Systems

Microwave Terrestrial Links

cdmaOne is a trademark of CDMA Development Group.
cdma2000 is a registered trademark of Telecommunications Industry Association.

Features

- ◆ 1300MHz to 2700MHz RF Frequency Range*
- ◆ 37dBm Constant OIP3 (Over All Gain Settings)
- ◆ 23.8dBm Output 1dB Compression Point
- ◆ 15.5dB Typical Gain at Maximum Gain Setting
- ◆ 0.5dB Gain Flatness Over 100MHz Bandwidth
- ◆ 6dB Noise Figure at Maximum Gain Setting (Using 1 Attenuator)
- ◆ Two Gain-Control Ranges: 21dB and 42dB
- ◆ Analog Gain Control
- ◆ Single +5V Supply Voltage
- ◆ Pin Compatible with MAX2056, 800MHz to 1000MHz RF VGA
- ◆ External Current-Setting Resistors Provide Option for Operating VGA in Reduced-Power/Reduced-Performance Mode
- ◆ Lead-Free Package Available

*Note: Operation beyond this range is possible, but has not been characterized.

Ordering Information

PART	TEMP RANGE	PIN-PACKAGE
MAX2057ETX+	-40°C to +85°C	36 Thin QFN-EP** 6mm x 6mm
MAX2057ETX+T	-40°C to +85°C	36 Thin QFN-EP** 6mm x 6mm

**EP = Exposed pad.

+Denotes a lead(Pb)-free/RoHS-compliant package.

T = Tape-and-reel package.

Pin Configuration/Functional Diagram appear at end of data sheet.

1300MHz to 2700MHz Variable-Gain Amplifier with Analog Gain Control

ABSOLUTE MAXIMUM RATINGS

V _{CC} to GND	-0.3V to +5.5V	θ _{JA} (2.5m/s airflow)	29°C/W
V _{CNTL} to GND (with V _{CC} applied)	0V to 4.75V	θ _{JC} (junction to exposed pad)	10°C/W
Current into V _{CNTL} pin (V _{CC} grounded)	40mA	Operating Temperature Range	-40°C to +85°C
All Other Pins to GND	-0.3V to (V _{CC} + 0.3V)	Storage Temperature Range	-65°C to +150°C
RF Input Power (IN, IN_A, ATTN_OUT, OUT_A)	+20dBm	Junction Temperature	+150°C
RF Input Power (AMP_IN)	+12dBm	Lead Temperature (soldering, 10s)	+300°C
θ _{JA} (natural convection)	35°C/W	Soldering Temperature (reflow)	+260°C
θ _{JA} (1m/s airflow)	31°C/W		

Stresses beyond those listed under "Absolute Maximum Ratings" may cause permanent damage to the device. These are stress ratings only, and functional operation of the device at these or any other conditions beyond those indicated in the operational sections of the specifications is not implied. Exposure to absolute maximum rating conditions for extended periods may affect device reliability.

DC ELECTRICAL CHARACTERISTICS

(V_{CC} = +4.75V to +5.25V, no RF signals applied, all input and output ports terminated with 50Ω, T_A = -40°C to +85°C, unless otherwise noted. Typical values are at V_{CC} = +5.0V, T_A = +25°C, unless otherwise noted.)

PARAMETER	CONDITIONS	MIN	TYP	MAX	UNITS
Supply Voltage		4.75	5	5.25	V
Supply Current	R1 = 1.2kΩ, R2 = 2kΩ (Note 1)		180	230	mA
R _{SET1} Current	R1 = 1.2kΩ (Note 1)		1		mA
R _{SET2} Current	R1 = 2kΩ (Note 1)		0.6		mA
Gain-Control Voltage Range	(Note 2)	1.0		4.5	V
Gain-Control Pin Input Resistance	V _{CNTL} = 1V to 4.5V	50			kΩ

RECOMMENDED AC OPERATING CONDITIONS

PARAMETER	CONDITIONS	MIN	TYP	MAX	UNITS
Frequency Range	(Note 3)	1300		2700	MHz

AC ELECTRICAL CHARACTERISTICS

(Typical Operating Circuit with one attenuator connected, V_{CC} = +4.75V to +5.25V, T_A = -40°C to +85°C, f_{IN} = 1700MHz to 2500MHz, unless otherwise noted. Typical values are at V_{CC} = +5.0V, R1 = 1.2kΩ, R2 = 2kΩ, P_{OUT} = +5dBm, f_{IN} = 2100MHz, V_{CNTL} = 1V, 50Ω system impedance, second attenuator is not connected, T_A = +25°C, unless otherwise noted.) (Note 4)

PARAMETER	CONDITIONS	MIN	TYP	MAX	UNITS
Gain	T _A = +25°C, V _{CC} = 5.0V, f _{IN} = 2100MHz	13.5	15.5	17.5	dB
	T _A = +25°C, V _{CC} = 5.0V, f _{IN} = 1560MHz	11.5	14.5	16.5	
	T _A = +25°C, V _{CC} = 5.0V, f _{IN} = 1500MHz	11.5	14.3	16.5	
	T _A = +25°C, V _{CC} = 5.0V, f _{IN} = 1450MHz	11.5	14	16.5	
Maximum Gain Variation	T _A = +25°C to -40°C	V _{CNTL} = 1V		+0.9	dB
		V _{CNTL} = 1.8V		+0.41	
		V _{CNTL} = 2.6V		+0.09	
		V _{CNTL} = 3.5V		-0.16	
	T _A = +25°C to +85°C	V _{CNTL} = 1V		-1	
		V _{CNTL} = 1.8V		-0.56	
		V _{CNTL} = 2.6V		-0.32	
		V _{CNTL} = 3.5V		+0.1	

1300MHz to 2700MHz Variable-Gain Amplifier with Analog Gain Control

AC ELECTRICAL CHARACTERISTICS (continued)

(Typical Operating Circuit with one attenuator connected, $V_{CC} = +4.75V$ to $+5.25V$, $T_A = -40^{\circ}C$ to $+85^{\circ}C$, $f_{IN} = 1700MHz$ to $2500MHz$, unless otherwise noted. Typical values are at $V_{CC} = +5.0V$, $R_1 = 1.2k\Omega$, $R_2 = 2k\Omega$, $P_{OUT} = +5dBm$, $f_{IN} = 2100MHz$, $V_{CNTL} = 1V$, 50Ω system impedance, second attenuator is not connected, $T_A = +25^{\circ}C$, unless otherwise noted.) (Note 3)

PARAMETER	CONDITIONS	MIN	TYP	MAX	UNITS
Reverse Isolation			37		dB
Noise Figure	(Note 5)		6		dB
Output 1dB Compression Point			+23.8		dBm
Output 2nd-Order Intercept Point	From maximum gain to 15dB attenuation, measured at $f_1 + f_2$ (Note 6)		+64		dBm
Output 3rd-Order Intercept Point	From maximum gain to 15dB attenuation (Note 5)		+37		dBm
Output 3rd-Order Intercept Point Variation Over Temperature	$T_A = +25^{\circ}C$ to $+85^{\circ}C$		-0.83		dB
	$T_A = +25^{\circ}C$ to $-40^{\circ}C$		-0.6		
2nd Harmonic	From maximum gain to 15dB attenuation, $P_{OUT} = +5dBm$		-65		dBc
3rd Harmonic	From maximum gain to 15dB attenuation, $P_{OUT} = +5dBm$		-83		dBc
RF Gain-Control Range	$f_{IN} = 1700MHz$ to $2200MHz$, $V_{CNTL} = 1V$ to $4V$	One attenuator	17	20.7	dB
		Two attenuators	34	42.4	
	$f_{IN} = 1450MHz$ to $1560MHz$, $V_{CNTL} = 1V$ to $4V$	One attenuator	17	22	
		Two attenuators	34	44	
RF Gain-Control Slope	$V_{CNTL} = 1.8V$ to $3.5V$		-10		dB/V
Maximum RF Gain-Control Slope	Maximum slope vs. gain-control voltage		-15.2		dB/V
Gain Flatness Over 100MHz Bandwidth	Peak-to-peak for all settings		0.5		dB
Attenuator Switching Time	15dB attenuation change (Note 7)		500		ns
Attenuator Insertion Loss	Second attenuator (IN_A, OUT_A)		2.2		dB
Input Return Loss	Entire band, all gain settings		18		dB
Output Return Loss	Entire band, all gain settings		15		dB
Group Delay	Input/output 50Ω lines de-embedded		300		ps
Group Delay Flatness Over 100MHz Bandwidth	Peak to peak		20		ps
Group Delay Change vs. Gain Control	$V_{CNTL} = 1V$ to $4V$		-70		ps
Insertion Phase Change vs. Gain Control	$V_{CNTL} = 1V$ to $4V$		50		degrees

Note 1: Total supply current reduces as R_1 and R_2 are increased.

Note 2: Operating outside this range for extended periods may affect device reliability. Limit pin input current to 40mA when V_{CC} is not present.

Note 3: Operation outside this range is possible, but with degraded performance of some parameters.

Note 4: All limits include external component losses, unless otherwise noted.

Note 5: Noise figure increases by approximately 1dB for every 1dB of gain reduction.

Note 6: $f_1 = 2100MHz$, $f_2 = 2101MHz$, +5dBm/tone at OUT.

Note 7: Switching time is measured from 50% of the control signal to when the RF output settles to $\pm 1dB$.

1300MHz to 2700MHz Variable-Gain Amplifier with Analog Gain Control

Typical Operating Characteristics

One Attenuator Configuration

(Typical Application Circuit with **one attenuator** connected, $V_{CC} = +5.0V$, $R1 = 1.2k\Omega$, $R2 = 2k\Omega$, $f_{IN} = 2100MHz$, maximum gain setting, $P_{OUT} = +5dBm$, linearity measured at $P_{OUT} = +5dBm/$ tone, $T_A = +25^\circ C$, unless otherwise noted.)

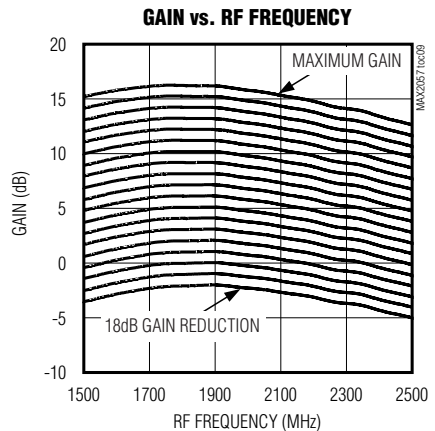
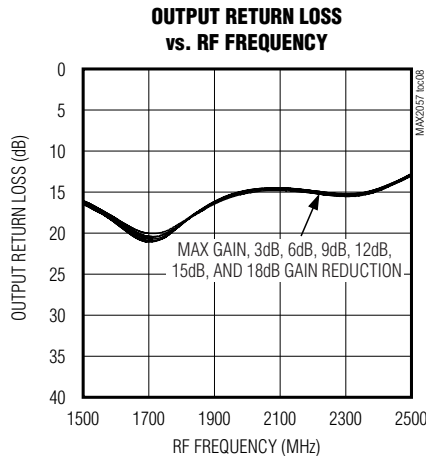
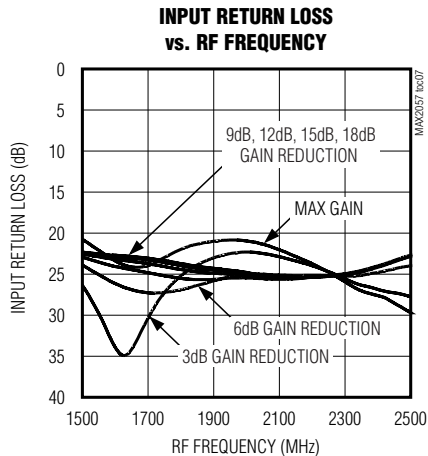
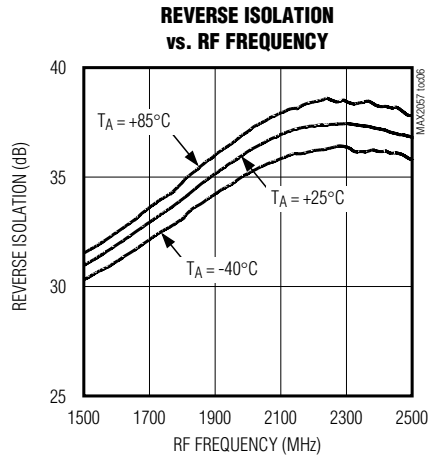
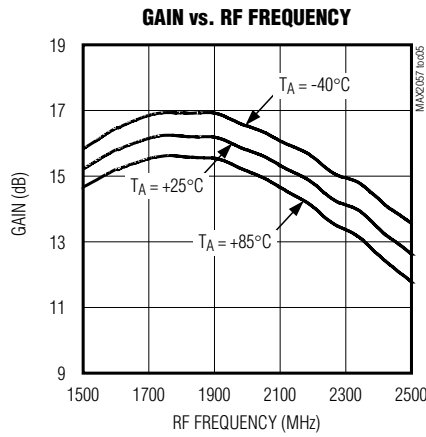
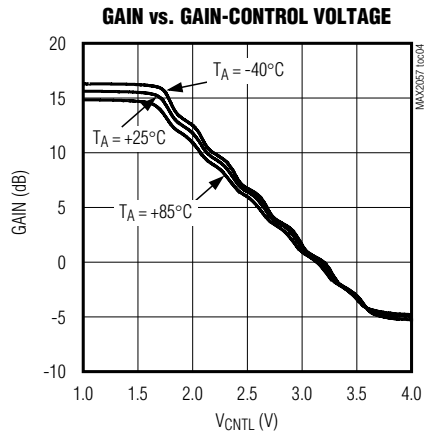
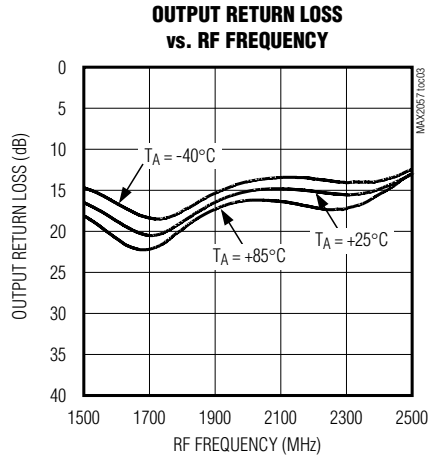
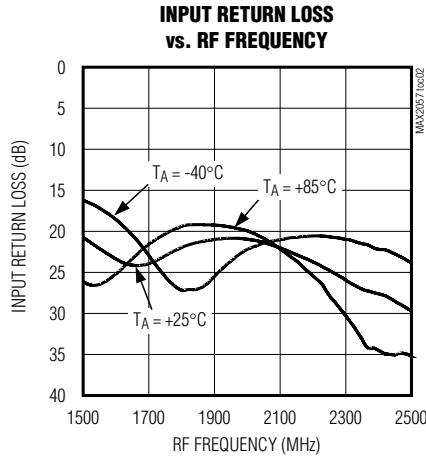
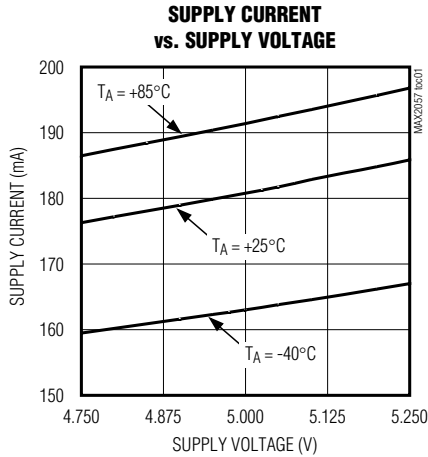

1300MHz to 2700MHz Variable-Gain Amplifier with Analog Gain Control

Typical Operating Characteristics (continued)

One Attenuator Configuration

(Typical Application Circuit with **one attenuator** connected, $V_{CC} = +5.0V$, $R1 = 1.2k\Omega$, $R2 = 2k\Omega$, $f_{IN} = 2100MHz$, maximum gain setting, $P_{OUT} = +5dBm$, linearity measured at $P_{OUT} = +5dBm/$ tone, $T_A = +25^\circ C$, unless otherwise noted.)

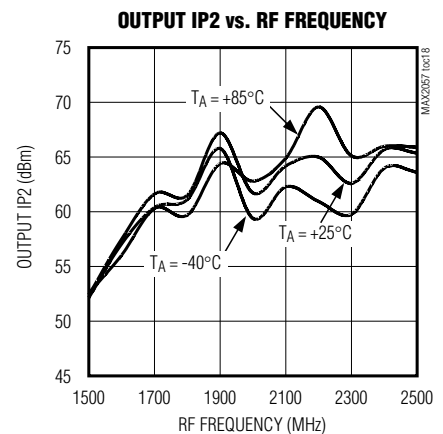
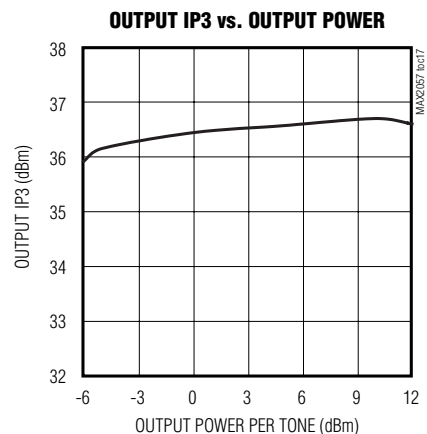
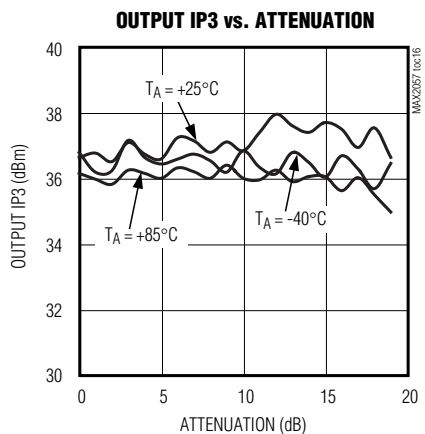
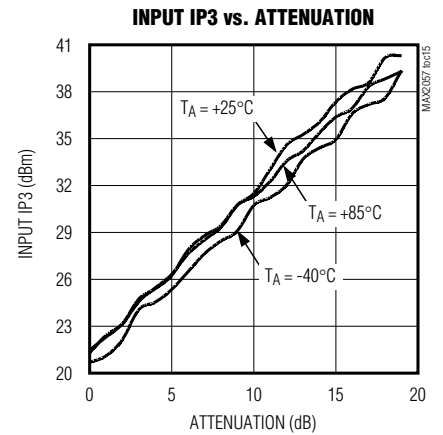
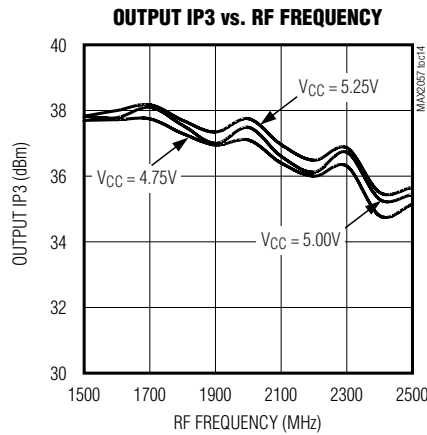
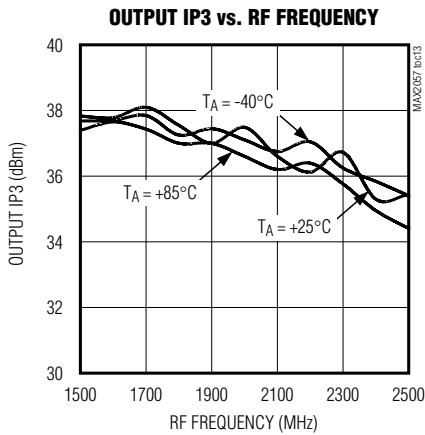
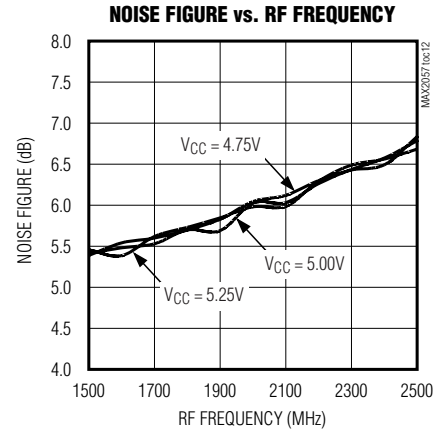
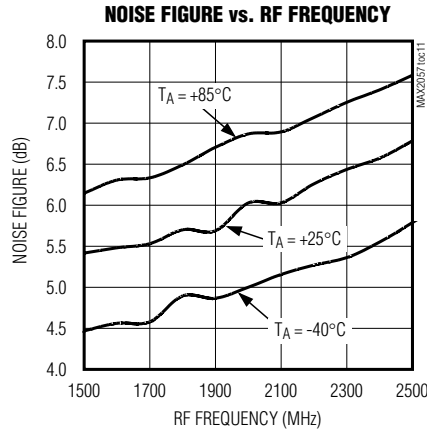
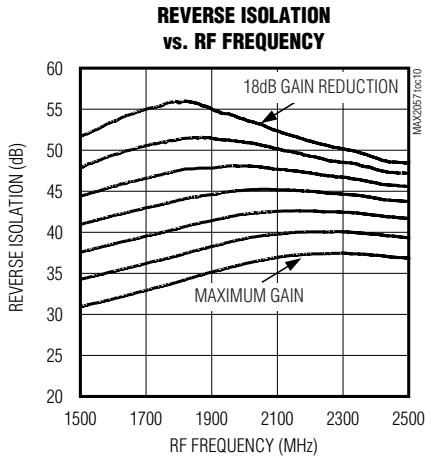

1300MHz to 2700MHz Variable-Gain Amplifier with Analog Gain Control

Typical Operating Characteristics (continued)

One Attenuator Configuration

(Typical Application Circuit with **one attenuator** connected, $V_{CC} = +5.0V$, $R1 = 1.2k\Omega$, $R2 = 2k\Omega$, $f_{IN} = 2100MHz$, maximum gain setting, $P_{OUT} = +5dBm$, linearity measured at $P_{OUT} = +5dBm/$ tone, $T_A = +25^\circ C$, unless otherwise noted.)

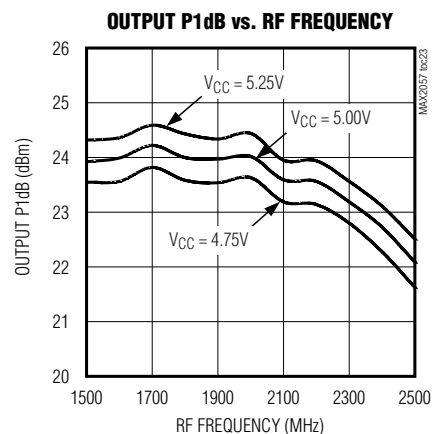
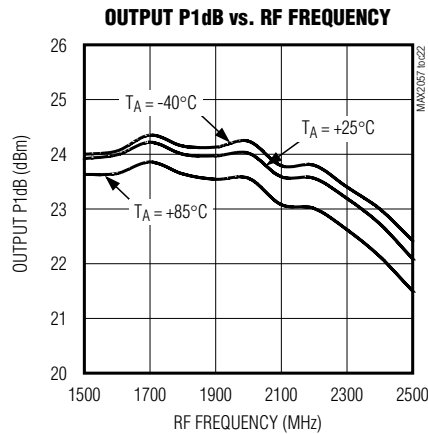
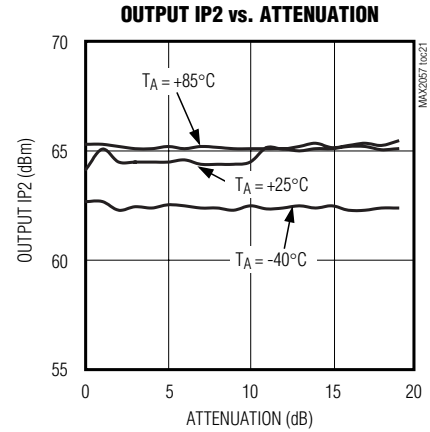
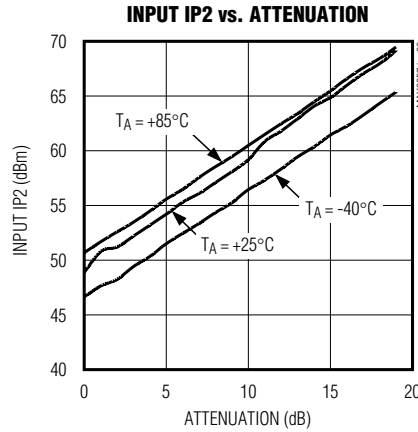
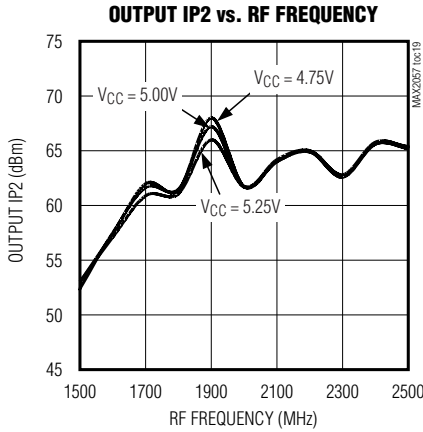

1300MHz to 2700MHz Variable-Gain Amplifier with Analog Gain Control

Typical Operating Characteristics

Two Attenuator Configuration

(Typical Application Circuit with **two attenuators** connected, $V_{CC} = +5.0V$, $R1 = 1.2k\Omega$, $R2 = 2k\Omega$, $f_{IN} = 2100MHz$, maximum gain setting, $P_{OUT} = +5dBm$, linearity measured at $P_{OUT} = +5dBm/$ tone, $T_A = +25^\circ C$, unless otherwise noted.)

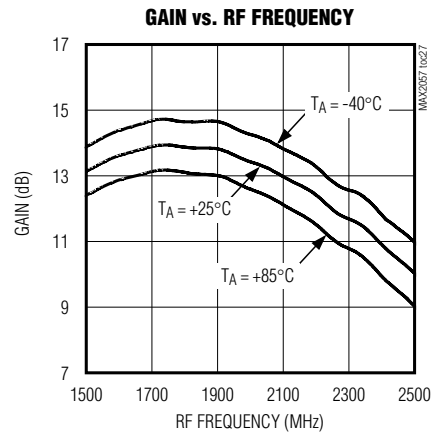
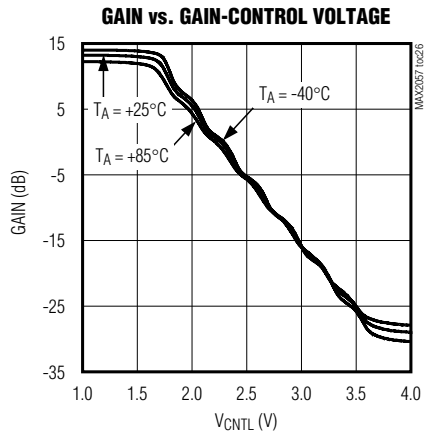
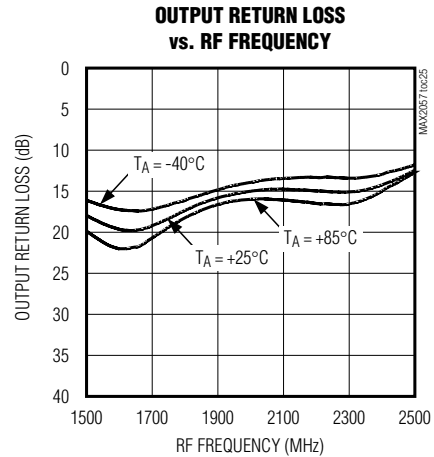
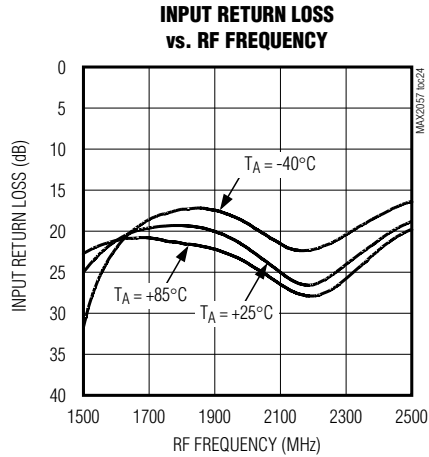

1300MHz to 2700MHz Variable-Gain Amplifier with Analog Gain Control

Typical Operating Characteristics (continued)

Two Attenuator Configuration

(Typical Application Circuit with **two attenuators** connected, $V_{CC} = +5.0V$, $R1 = 1.2k\Omega$, $R2 = 2k\Omega$, $f_{IN} = 2100MHz$, maximum gain setting, $P_{OUT} = +5dBm$, linearity measured at $P_{OUT} = +5dBm/$ tone, $T_A = +25^\circ C$, unless otherwise noted.)

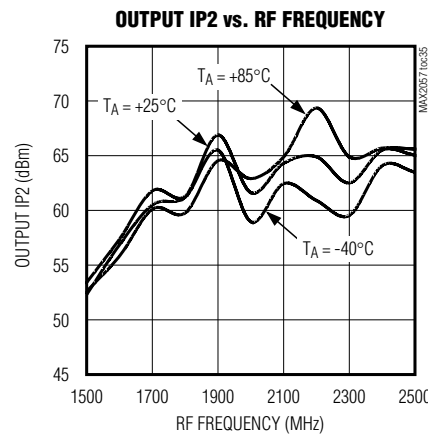
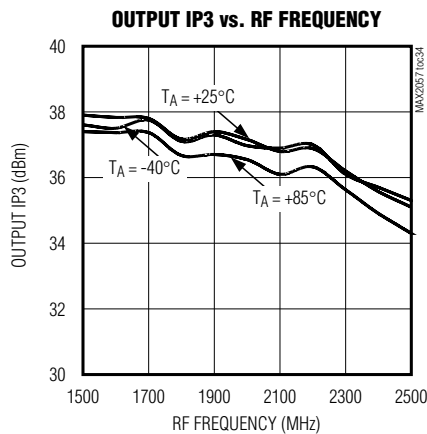
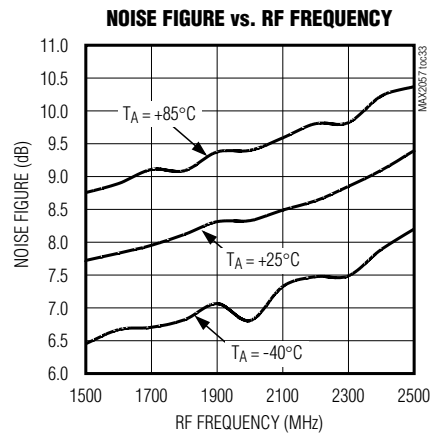
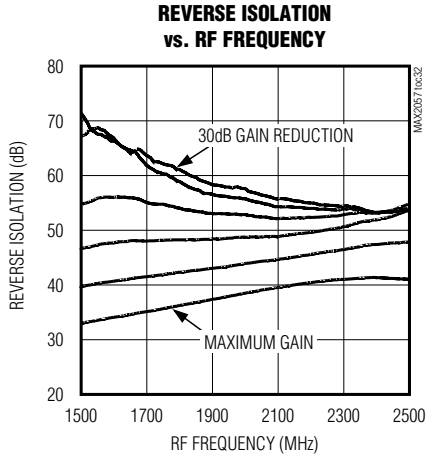
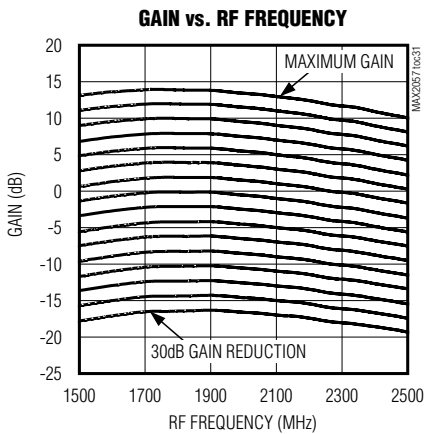
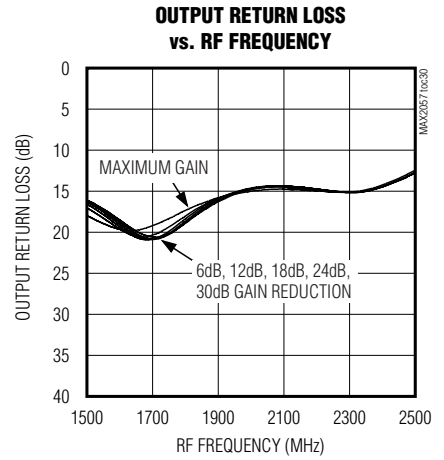
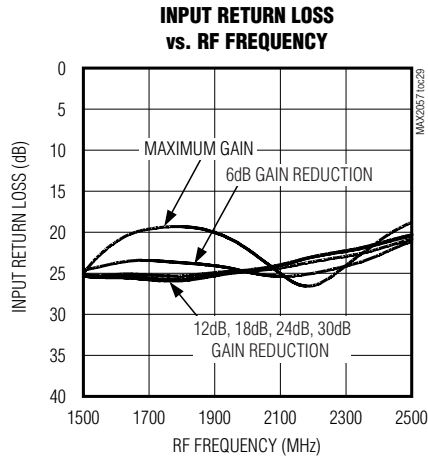
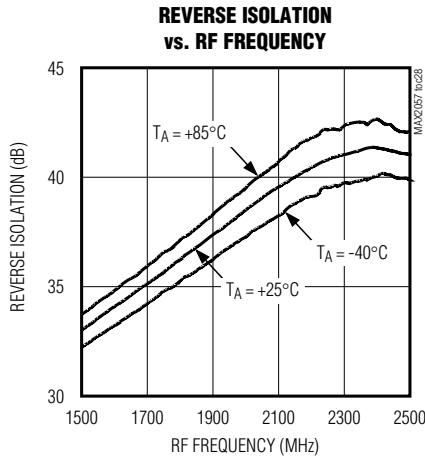

1300MHz to 2700MHz Variable-Gain Amplifier with Analog Gain Control

Pin Description

MAX2057

PIN	NAME	FUNCTION
1, 3, 4, 6, 7, 9, 10, 12, 14, 18, 19, 21–24, 27, 28, 30, 31, 33, 34, 36	GND	Ground. Connect to the board's ground plane using low-inductance layout techniques.
2	OUT_A	Second-Attenuator Output. Internally matched to 50Ω over the operating frequency band. Connect to IN through a DC-blocking capacitor if greater than 21dB of gain-control range is required. No connection is required if the second attenuator is not used.
5, 13, 16, 25, 32	VCC	Power Supply. Bypass each pin to GND with capacitors as shown in the <i>Typical Application Circuit</i> . Place capacitors as close to the pin as possible.
8	IN_A	Second-Attenuator Input. Internally matched to 50Ω over the operating frequency band. Connect to a 50Ω RF source through a DC-blocking capacitor if greater than 21dB of gain-control range is required. No connection is required if the second attenuator is not used.
11	VCNTL	Analog Gain-Control Input. Limit voltages applied to this pin to a 1V to 4.5V range when VCC is present to ensure device reliability.
15	RSET1	First-Stage Amplifier Bias-Current Setting. Connect to GND through a 1.2kΩ resistor.
17	RSET2	Second-Stage Amplifier Bias-Current Setting. Connect to GND through a 2kΩ resistor.
20	OUT	RF Output. Internally matched to 50Ω over the operating frequency band. Requires a DC-blocking capacitor and a shunt-matching capacitor.
26	AMP_IN	Amplifier Input. Internally matched to 50Ω over the operating frequency band. Connect to ATTN_OUT through a DC-blocking capacitor.
29	ATTN_OUT	Attenuator Output. Internally matched to 50Ω over the operating frequency band. Connect to AMP_IN through a DC-blocking capacitor.
35	IN	RF Input. Internally matched to 50Ω over the operating frequency band. Connect to a 50Ω RF source through a DC-blocking capacitor if the second attenuator is not used.
—	EP	Exposed Pad. This pad affects RF performance and provides heat dissipation. This pad MUST be soldered evenly to the board's ground plane for proper operation.

1300MHz to 2700MHz Variable-Gain Amplifier with Analog Gain Control

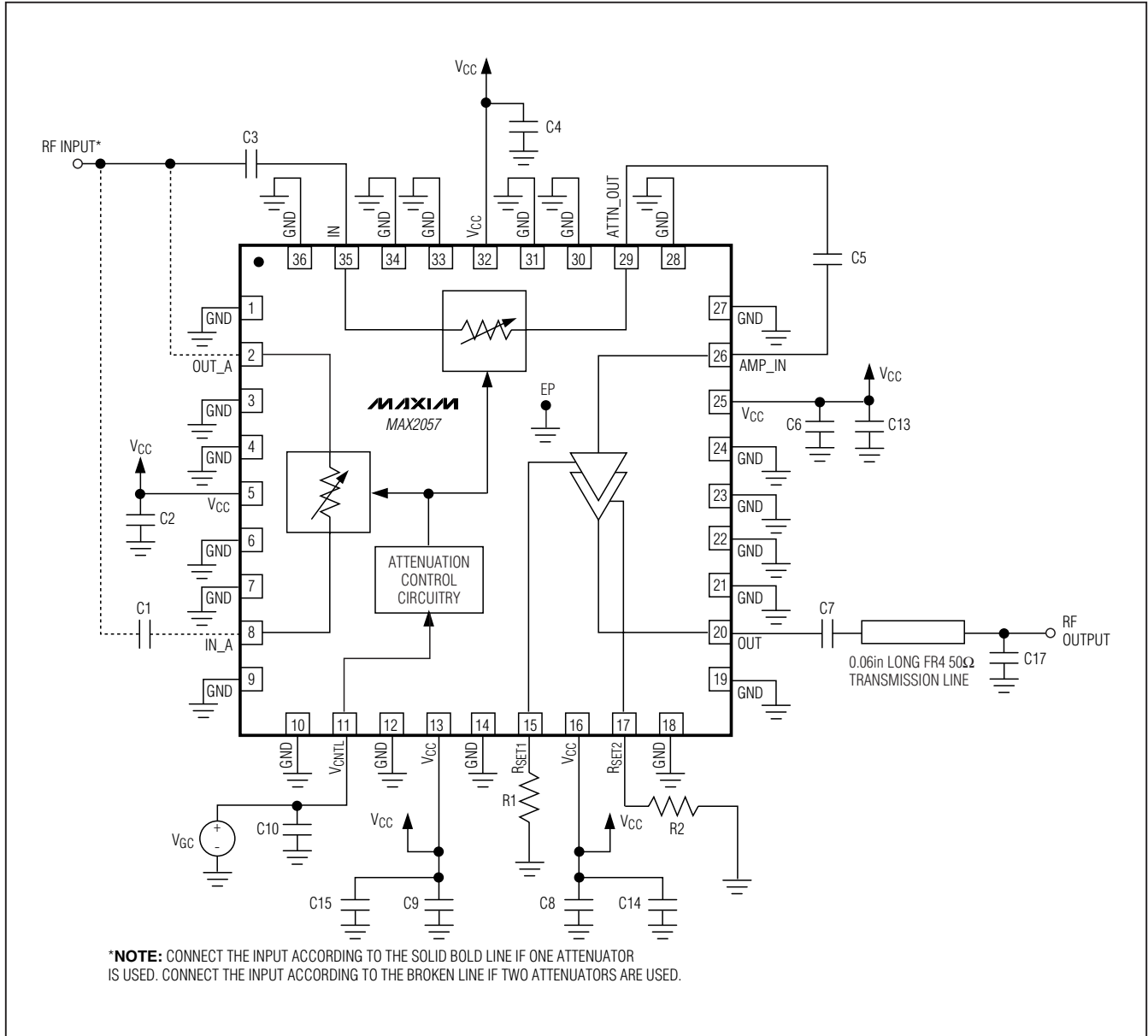

Figure 1. Typical Application Circuit

Detailed Description

The MAX2057 general-purpose, high-performance VGA with analog gain control is designed to interface with 50Ω systems operating in the 1300MHz to 2700MHz frequency range.

The MAX2057 integrates two attenuators to provide 21dB or 42dB of precision analog gain control, as well

as a two-stage amplifier that has been optimized to provide high gain, high IP3, low noise figure, and low power consumption. The bias current of each amplifier stage can be adjusted by individual external resistors to further reduce power consumption for applications that do not require high linearity.

1300MHz to 2700MHz Variable-Gain Amplifier with Analog Gain Control

Table 1. Typical Application Circuit Component Values

DESIGNATION	VALUE	TYPE
C1, C3, C5, C7, C10	22pF	Microwave capacitors (0402)
C2, C4, C6, C8, C9	1000pF	Microwave capacitors (0402)
C13, C14, C15	0.1μF	Microwave capacitors (0603)
C17	0.75pF	Microwave capacitor (0402)
R1	1.2kΩ	±1% resistor (0402)
R2	2kΩ	±1% resistor (0402)

Applications Information

Analog Attenuation Control

A single input voltage at the V_{CNTL} pin adjusts the gain of the MAX2057. Up to 21dB of gain-control range is provided through a single attenuator. At the maximum gain setting, each attenuator's insertion loss is approximately 2.2dB. With the single attenuator at the maximum gain setting, the device provides a nominal 15.5dB of cascaded gain and 6dB of cascaded noise figure.

If a larger gain-control range is desired, a second on-chip attenuator can be connected in the signal path to provide an additional 21dB of gain-control range. With the second attenuator connected at the maximum gain setting, the device typically exhibits 13.3dB of cascaded gain. Note that the V_{CNTL} pin simultaneously adjusts both on-chip attenuators.

The V_{CNTL} input voltage drives a high-impedance load ($> 50k\Omega$). It is suggested that a current-limiting resistor be included in series with this connection to limit the input current to less than 40mA should the control voltage be applied when V_{CC} is not present. A series resistor of greater than 200Ω will provide complete protection for 5V control voltage ranges. **Limit V_{CNTL} input voltages to a 1.0V to 4.5V range when V_{CC} is present to ensure the reliability of the device.**

Amplifier Bias Current

The MAX2057 integrates a two-stage amplifier to simultaneously provide high gain and high IP3. Optimal performance is obtained when R1 and R2 are equal to 1.2kΩ and 2kΩ, respectively. The typical supply current is 180mA and the typical output IP3 is 37dBm under these conditions.

Increasing R1 and R2 from the nominal values of 1.2kΩ and 2kΩ reduces the bias current of each amplifier stage, which reduces the total power consumption and IP3 of the device. This feature can be utilized to further decrease power consumption for applications that do not require high IP3.

Layout Considerations

A properly designed PC board is an essential part of any RF/microwave circuit. Keep RF signal lines as short as possible to reduce losses, radiation, and inductance. For best performance, route the ground-pin traces directly to the exposed pad underneath the package. This pad **MUST** be connected to the ground plane of the board by using multiple vias under the device to provide the best RF and thermal conduction path. Solder the exposed pad on the bottom of the device package to a PC board exposed pad.

Power-Supply Bypassing

Proper voltage-supply bypassing is essential for high-frequency circuit stability. Bypass each V_{CC} pin with capacitors placed as close to the device as possible. Place the smallest capacitor closest to the device. Refer to the MAX2057 evaluation kit data sheet for more details.

Exposed Pad RF and Thermal Considerations

The EP of the MAX2057's 36-pin thin QFN-EP package provides a low-thermal-resistance path to the die. It is important that the PC board on which the IC is mounted be designed to conduct heat from this contact. In addition, the EP provides a low-inductance RF ground path for the device.

The EP **MUST** be soldered to a ground plane on the PC board either directly or through an array of plated via holes. Soldering the pad to ground is also critical for efficient heat transfer. Use a solid ground plane wherever possible.

1300MHz to 2700MHz Variable-Gain Amplifier with Analog Gain Control

Pin Configuration/ Functional Diagram

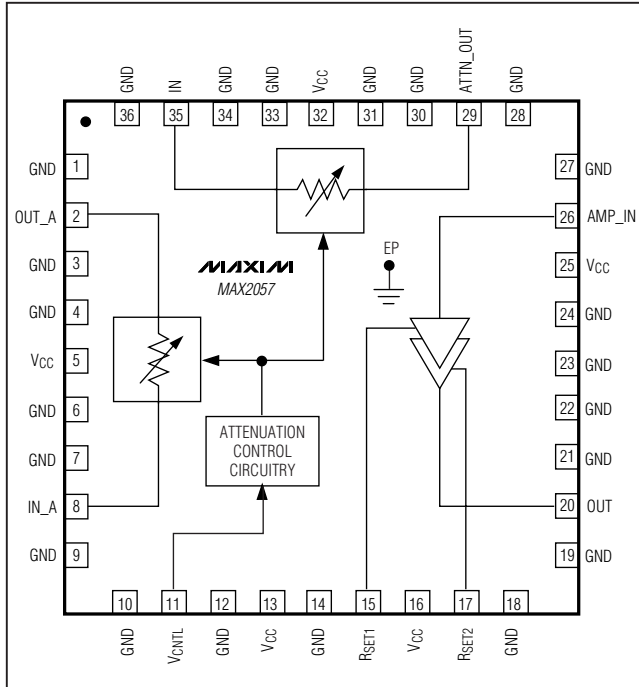

Chip Information

PROCESS: BiCMOS

Package Information

For the latest package outline information and land patterns, go to www.maxim-ic.com/packages. Note that a "+", "#", or "-" in the package code indicates RoHS status only. Package drawings may show a different suffix character, but the drawing pertains to the package regardless of RoHS status.

PACKAGE TYPE	PACKAGE CODE	OUTLINE NO.	LAND PATTERN NO.
36 TQFN-EP	T3666+2	21-0141	90-0049

1300MHz to 2700MHz Variable-Gain Amplifier with Analog Gain Control

Revision History

REVISION NUMBER	REVISION DATE	DESCRIPTION	PAGES CHANGED
0	1/05	Initial release	—
1	12/10	Updated <i>General Description, Features, Applications, Ordering Information, DC Electrical Characteristics, AC Electrical Characteristics, Detailed Description, and Analog Attenuation Control</i> sections, and added <i>Recommended AC Operating Conditions</i> section	1, 2, 3, 10, 11

MAX2057

Maxim cannot assume responsibility for use of any circuitry other than circuitry entirely embodied in a Maxim product. No circuit patent licenses are implied. Maxim reserves the right to change the circuitry and specifications without notice at any time.

Maxim Integrated Products, 120 San Gabriel Drive, Sunnyvale, CA 94086 408-737-7600 _____ 13