

**EVALUATION KIT
AVAILABLE**

MAXIM

RF Power Detector

MAX2204

General Description

The MAX2204 RF power detector is designed to operate from 450MHz to 2.5GHz. The device is ideal for wideband code-division multiple access (WCDMA), cdma2000®, and high-speed downlink/uplink packet access. The MAX2204 accepts an RF signal at the input, and outputs a highly repeatable voltage. The output voltage increases monotonically with increasing input power. The device is designed to compensate for temperature and process shifts, reducing the typical output variation to less than $\pm 0.5\text{dB}$ at full input power and $\pm 1.5\text{dB}$ at the lower power.

The MAX2204 features a detection range from -16dBm to +5dBm. High input impedance allows for low-loss resistive tap if an isolator is used. The device uses external termination at the input so that the RF signal from several directional couplers can be connected to a single detector chip.

The MAX2204 operates from a 2.7V to 3.3V power supply. The device is available in a tiny 5-pin SC70 package. Electrical performance is guaranteed over a -40°C to +85°C temperature range.

Applications

WCDMA, cdma2000
High-Speed Downlink Packet Access (HSDPA)
High-Speed Uplink Packet Access (HSUPA)

www.DataSheet4U.com

cdma2000 is a registered trademark of Telecommunications Industry Association.

Features

- ◆ -16dBm to +5dBm Detection Range
- ◆ $\pm 0.3\text{dB}$ Detection Error Due to Temperature
- ◆ +2.7V to +3.3V Single-Supply Operation
- ◆ Easy-to-Assemble, Lead-Free, 5-Pin SC70 Package

Ordering Information

PART	TEMP RANGE	PIN-PACKAGE	PKG CODE
MAX2204EXK+	-40°C to +85°C	5 SC70	X5+1

+ Denotes a lead-free package.

Pin Configuration

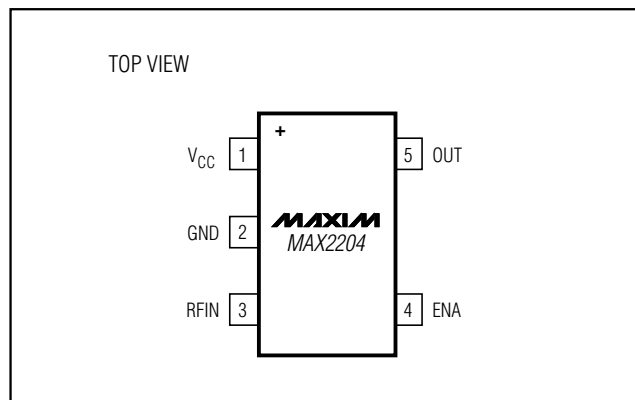

RF Power Detector

MAX2204

ABSOLUTE MAXIMUM RATINGS

V_{CC} to GND-0.3V to +3.6V
 OUT, Logic Input (ENA) to GND-0.3V to (V_{CC} + 0.3V)
 RF Input Power+10dBm
 Continuous Power Dissipation (T_A = +70°C)
 (derate 3.1mW/°C above +70°C)247mW
 Operating Temperature Range-40°C to +85°C

Junction Temperature+150°C
 θ_{JC} +115°C/W
 θ_{JA} +324°C/W
 Storage Temperature Range-65°C to +160°C
 Lead Temperature (soldering, 10s)+300°C

Stresses beyond those listed under "Absolute Maximum Ratings" may cause permanent damage to the device. These are stress ratings only, and functional operation of the device at these or any other conditions beyond those indicated in the operational sections of the specifications is not implied. Exposure to absolute maximum rating conditions for extended periods may affect device reliability.

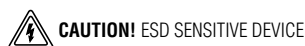

Note: This part is not for automotive applications.

DC ELECTRICAL CHARACTERISTICS

(V_{CC} = 2.7V to 3.3V, T_A = -40°C to +85°C, ENA = 2.0V, no RF signal applied. Typical values are at V_{CC} = 2.85V, T_A = +25°C, unless otherwise noted.) (Note 1)

PARAMETER	SYMBOL	CONDITIONS	MIN	TYP	MAX	UNITS
Supply Voltage	V _{CC}		2.7		3.3	V
Operating Supply Current	I _{CC}			1.2	2.5	mA
Sleep Mode Supply Current		ENA = 0V		0.5	10	μA
ENA Logic-High Threshold	V _{IH}		2			V
ENA Logic-Low Threshold	V _{IL}				0.6	V
ENA Input Current		ENA = 2V	-2		+10	μA
		ENA = 0.6V	-2		+1	

AC ELECTRICAL CHARACTERISTICS

(MAX2204 Evaluation Kit, V_{CC} = 2.85V, T_A = -40°C to +85°C, ENA = 2.0V, f_{RF} = 450MHz to 2.5GHz. Typical values are at V_{CC} = 2.85V, T_A = +25°C, unless otherwise noted.) (Note 1)

PARAMETER	SYMBOL	CONDITIONS	MIN	TYP	MAX	UNITS
RF Input Frequency			450		2500	MHz
RF Input Level for 2.0V		T _A = +25°C, RFIN at 836MHz	3.3	4.8	6.3	dBm
		T _A = +25°C, RFIN at 1880MHz	1.9	3.4	4.9	
Minimum Input Level		-16dBm to -15dBm change in P _{IN} (836MHz to 2500MHz)	8	14		mV
Power Detector Accuracy Due to Temperature		V _{CC} = 2.85V, 836MHz to 1880MHz T _A = -40°C to +85°C (Note 2)	P _{IN} for 2.0V output	±0.5	±1.1	dB
			P _{IN} for 0.1V output	±1.5	±4	
In-Band Variation		824MHz to 849MHz		0.1		dB
		1850MHz to 1980MHz		0.2		

Note 1: Specifications over T_A = -40°C to +85°C are guaranteed by design. Production tests are performed at T_A = +25°C.

Note 2: Guaranteed by design and characterization.

RF Power Detector

MAX2204

Typical Operating Characteristics

(MAX2204 Evaluation Kit, typical values are at $V_{CC} = 2.85V$, $EN_A = 2.0V$, $T_A = +25^\circ C$, modulation equals CW, unless otherwise noted.)

OUTPUT VOLTAGE vs. INPUT POWER

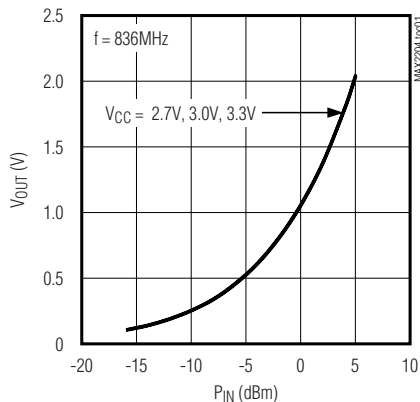

OUTPUT VOLTAGE vs. INPUT POWER

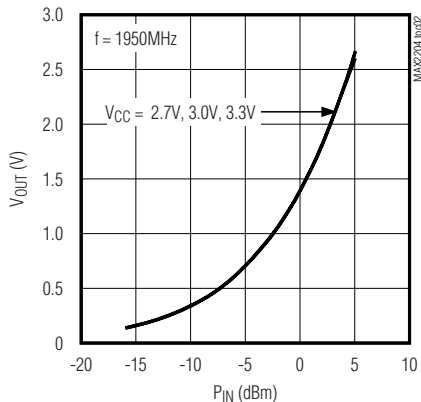

DETECTOR ERROR FROM $T_A = +25^\circ C$ AT 450MHz

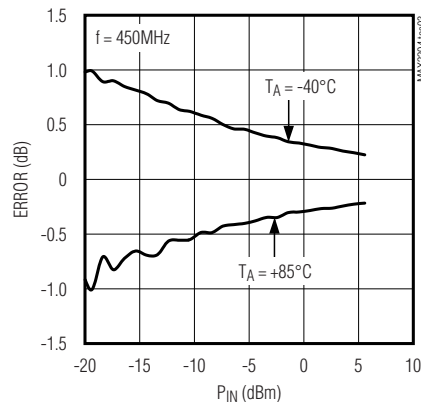

DETECTOR ERROR FROM $T_A = +25^\circ C$ AT 824MHz

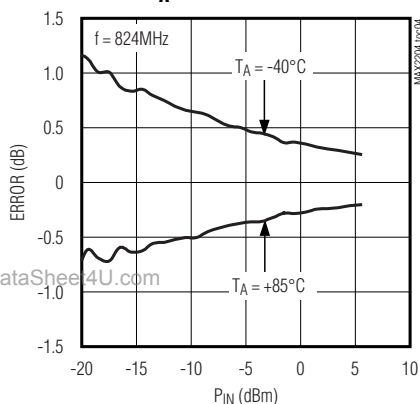

DETECTOR ERROR FROM $T_A = +25^\circ C$ AT 849MHz

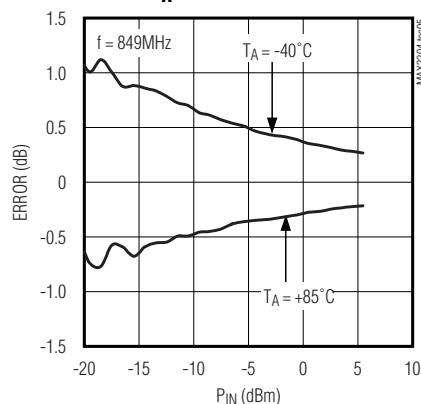

DETECTOR ERROR FROM $T_A = +25^\circ C$ AT 1850MHz

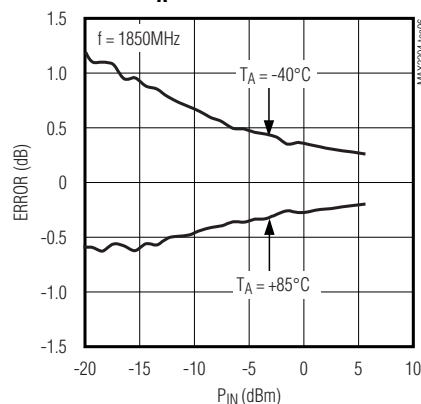

DETECTOR ERROR FROM $T_A = +25^\circ C$ AT 1910MHz

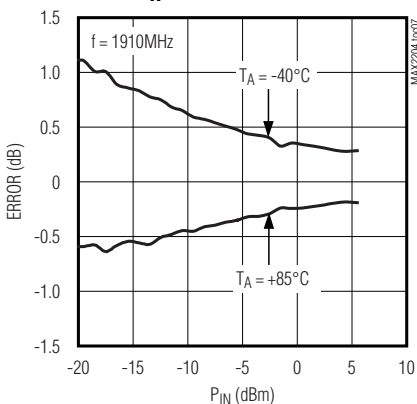

DETECTOR ERROR FROM $T_A = +25^\circ C$ AT 2500MHz

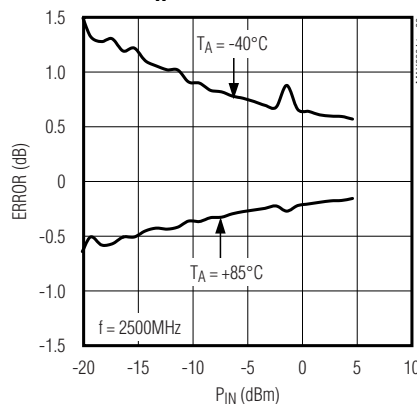

www.DataSheet4U.com

RF Power Detector

Typical Operating Characteristics (continued)

(MAX2204 Evaluation Kit, typical values are at $V_{CC} = 2.85V$, $ENA = 2.0V$, $T_A = +25^\circ C$, modulation equals CW, unless otherwise noted.)

OUTPUT VOLTAGE vs. INPUT POWER AT 836MHz WITH RESISTIVE TAP

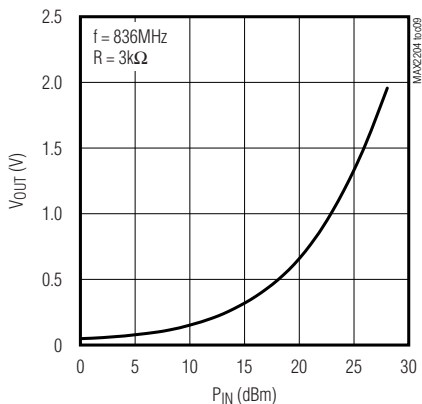

OUTPUT VOLTAGE vs. INPUT POWER AT 1880MHz WITH RESISTIVE TAP

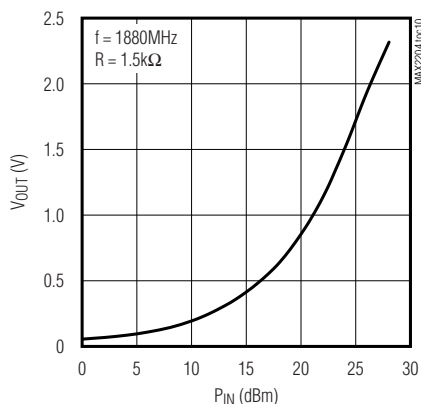

RESPONSE TIME

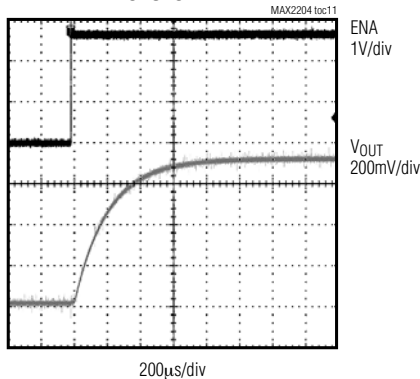

DEVIATION FROM DPCCH+1DPDCH, 1950MHz

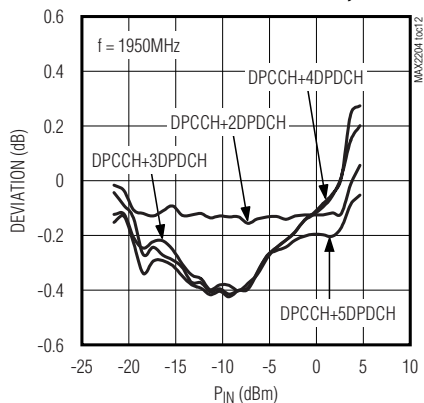

OUTPUT VOLTAGE vs. INPUT POWER WITH WCDMA DOWNLINK

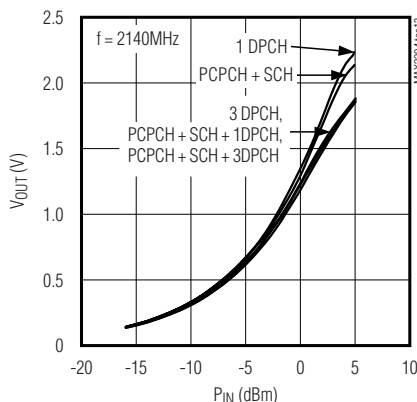

RF Power Detector

Pin Description

PIN	NAME	FUNCTION
1	V _{CC}	Power-Supply Pin. Bypass to GND with a capacitor as close as possible to the pin.
2	GND	Ground Connection. Use multiple ground vias to connect the GND pin to the ground plane.
3	RFIN	RF Input. AC-couple with an external capacitor.
4	ENA	Enable Input. Drive low to turn the part off. Drive high or connect to V _{CC} to turn the part on.
5	OUT	Power Detector Output. Filter with a capacitor to GND.

MAX2204

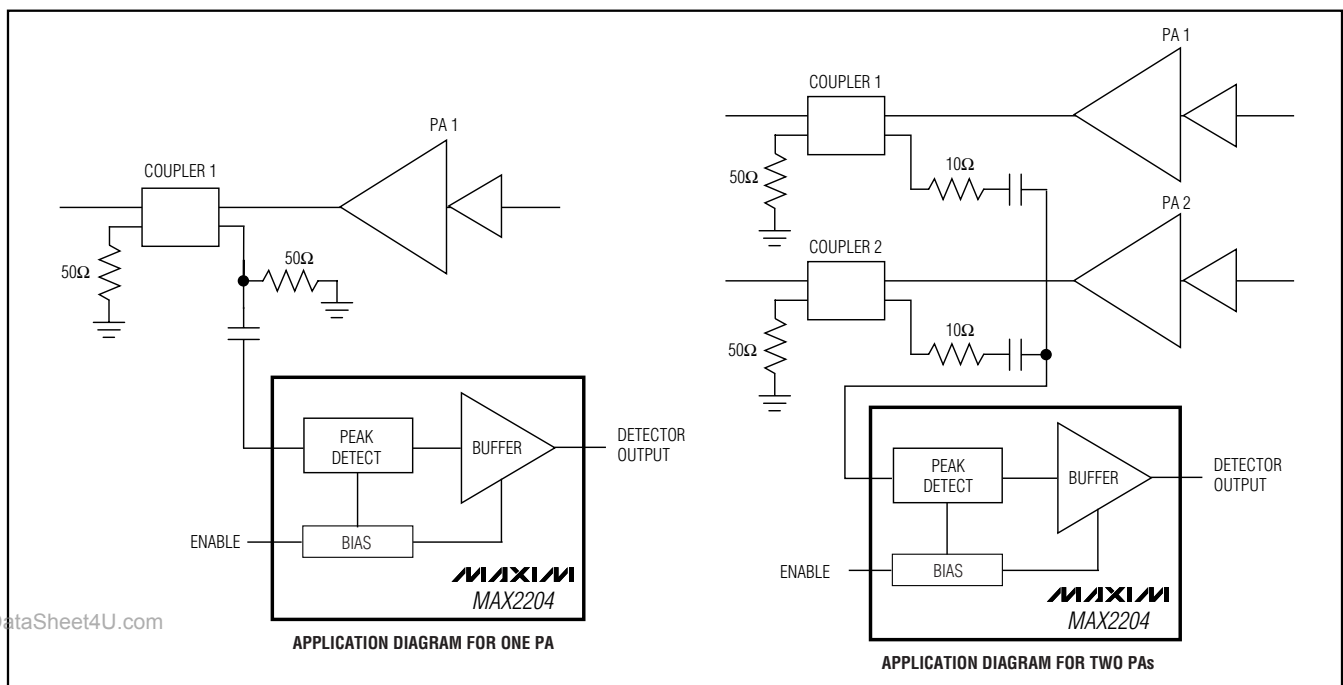

Figure 1. Typical Application Circuit

Detailed Description

The MAX2204 RF power detector is designed to operate from 450MHz to 2.5GHz. The device accepts an RF signal at the input and outputs a highly repeatable voltage, which increases monotonically with increasing input power. See the *Typical Operating Characteristics*. The device is designed to compensate for temperature and process shifts, reducing the typical output variation to less than $\pm 0.5\text{dB}$ at full input power and $\pm 1.5\text{dB}$ at the lower power.

The MAX2204 features a detection range from -16dBm to $+5\text{dBm}$. High input impedance allows a for low-loss resistive tap if an isolator is used. The device uses external termination at the input so that the RF signal from several directional couplers can be connected to a single detector chip.

The MAX2204 features an enable input (ENA) that allows the device to be put in shutdown. For normal operation, drive ENA high or connect to V_{CC}. For device shutdown, drive ENA low.

The MAX2204 integrates an output series resistor of approximately $100\text{k}\Omega$. For output filtering, connect only a capacitor to ground at the output.

Applications Information

The MAX2204 uses external termination when using directional couplers. See Figure 1 for the typical application circuit. The output of the detector is typically connected to an ADC in cdma2000 or WCDMA power-control topology.

RF Power Detector

MAX2204

Table 1. MAX2204 Input Impedance Over Frequency

FREQUENCY (GHz)	P _{IN} = -16dBm		P _{IN} = +5dBm	
	REAL (Ω)	IMAG (jΩ)	REAL (Ω)	IMAG (jΩ)
0.4	109.3	-556.5	120.0	-563.3
0.6	80.5	-369.0	91.0	-379.3
0.8	73.4	-300.3	80.8	-310.7
1.0	64.1	-260.2	75.6	-275.8
1.2	65.8	-216.4	79.9	-231.3
1.4	62.3	-194.9	64.4	-202.8
1.6	48.9	-177.5	53.9	-192.3
1.8	33.1	-157.4	39.9	-174.6
2.0	21.8	-142.2	25.9	-158.3
2.2	15.2	-131.2	18.3	-144.5
2.4	10.6	-116.8	10.6	-131.9
2.6	11.8	-99.8	10.6	-115.6

Layout

The MAX2204 is not particularly sensitive to the layout, since it only needs 5dBm for maximum output voltage. However, there are two areas that need attention: the GND pin and the supply bypassing. The GND pin should be connected to the PCB ground with a GND via as close as possible, and the supply bypass capacitor should be close to the part.

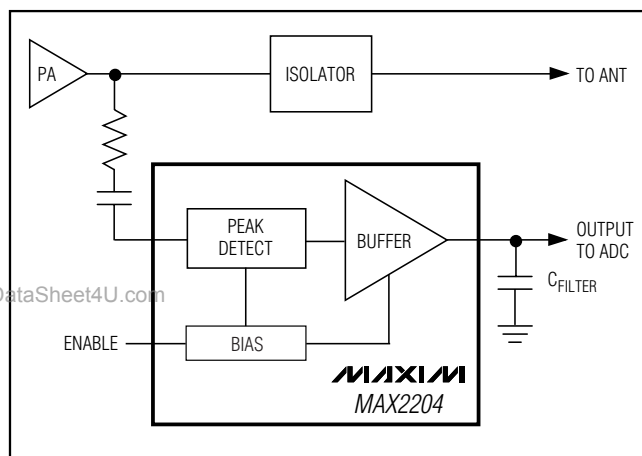

Figure 2. Typical Application Circuit Using Resistive Tapping from a Power Amplifier

The MAX2204 has high input impedance to allow for high-value resistive tapping from a power amplifier. This coupling method is the lowest cost and lowest power loss when used with an isolator. See Figure 2 for the typical application circuit.

The MAX2204 input impedance over frequency is listed in Table 1.

RF Power Detector

Package Information

(The package drawing(s) in this data sheet may not reflect the most current specifications. For the latest package outline information go to www.maxim-ic.com/packages.)

MAX2204

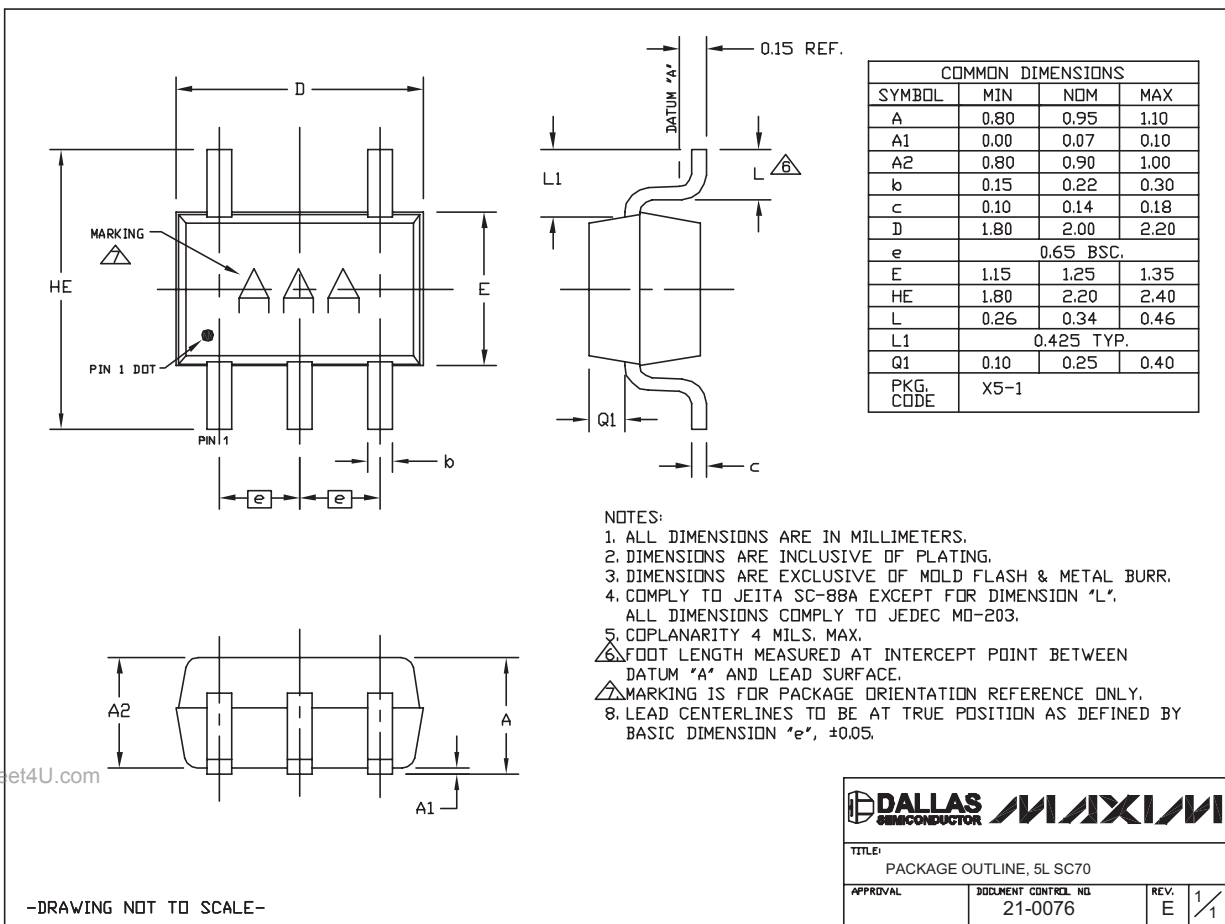

SC70, 5L, EPS

www.DataSheet4U.com

DALLAS SEMICONDUCTOR **MAXIM**

TITLE: PACKAGE OUTLINE, 5L SC70

APPROVAL	DOCUMENT CONTROL NO. 21-0076	REV. E	1/1
----------	---------------------------------	-----------	-----

Maxim cannot assume responsibility for use of any circuitry other than circuitry entirely embodied in a Maxim product. No circuit patent licenses are implied. Maxim reserves the right to change the circuitry and specifications without notice at any time.

Maxim Integrated Products, 120 San Gabriel Drive, Sunnyvale, CA 94086 408-737-7600 _____ 7