



# High-Speed, Single-Supply, Gain of 2, Closed-Loop, Rail-to-Rail Buffers with Enable

## General Description

The MAX4214/MAX4215/MAX4217/MAX4219/MAX4222 are precision, closed-loop, gain of +2 (or -1) buffers featuring high slew rates, high output current drive, and low differential gain and phase error. They operate with a single 3.15V to 11V supply or with  $\pm 1.575V$  to  $\pm 5.5V$  dual supplies. The input common-mode voltage range extends 100mV beyond the negative power-supply rail, and the output swings Rail-to-Rail<sup>®</sup>.

These devices require only 5.5mA of quiescent supply current while achieving a 230MHz -3dB bandwidth and a 600V/ $\mu$ s slew rate. In addition, the MAX4215/MAX4219 have a disable feature that reduces the supply current to 400 $\mu$ A per buffer. Input voltage noise is only 10nV/ $\sqrt{Hz}$ , and input current noise is only 1.3pA/ $\sqrt{Hz}$ . This buffer family is ideal for low-power/low-voltage applications requiring wide bandwidth, such as video, communications, and instrumentation systems. For space-sensitive applications, the MAX4214 comes in a miniature 5-pin SOT23 package.

## Ordering Information

| PART         | TEMP RANGE     | PIN-PACKAGE | TOP MARK |
|--------------|----------------|-------------|----------|
| MAX4214EUK-T | -40°C to +85°C | 5 SOT23-5   | ABAH     |
| MAX4215ESA   | -40°C to +85°C | 8 SO        | —        |
| MAX4215EUA   | -40°C to +85°C | 8 $\mu$ MAX | —        |
| MAX4217ESA   | -40°C to +85°C | 8 SO        | —        |
| MAX4217EUA   | -40°C to +85°C | 8 $\mu$ MAX | —        |
| MAX4219ESD   | -40°C to +85°C | 14 SO       | —        |
| MAX4219EEE   | -40°C to +85°C | 16 QSOP     | —        |
| MAX4222ESD   | -40°C to +85°C | 14 SO       | —        |
| MAX4222EEE   | -40°C to +85°C | 16 QSOP     | —        |

## Applications

Battery-Powered Instruments  
Video Line Drivers  
Analog-to-Digital Converter Interface  
CCD Imaging Systems  
Video Routing and Switching Systems  
Video Multiplexing Applications

Typical Application Circuit appears at end of data sheet.

Rail-to-Rail is a registered trademark of Nippon Motorola, Ltd.

## Features

- ◆ Internal Precision Resistors for Closed-Loop Gains of +2V/V or -1V/V
- ◆ High Speed
  - 230MHz -3dB Bandwidth
  - 90MHz 0.1dB Gain Flatness (MAX4219/MAX4222)
  - 600V/ $\mu$ s Slew Rate
- ◆ Single 3.3V/5.0V Operation
- ◆ Outputs Swing Rail-to-Rail
- ◆ Input Common-Mode Range Extends Beyond  $V_{EE}$
- ◆ Low Differential Gain/Phase Error: 0.03%/0.04°
- ◆ Low Distortion at 5MHz
  - 72dBc SFDR
  - 71dB Total Harmonic Distortion
- ◆ High Output Drive:  $\pm 120mA$
- ◆ Low 5.5mA Supply Current
- ◆ 400 $\mu$ A Shutdown Supply Current (MAX4215/MAX4219)
- ◆ Space-Saving SOT23,  $\mu$ MAX, or QSOP Packages

## Selector Guide

| PART    | NO. OF AMPS | ENABLE | PIN-PACKAGE     |
|---------|-------------|--------|-----------------|
| MAX4214 | 1           | No     | 5 SOT23         |
| MAX4215 | 1           | Yes    | 8 SO/ $\mu$ MAX |
| MAX4217 | 2           | No     | 8 SO/ $\mu$ MAX |
| MAX4219 | 3           | Yes    | 14 SO, 16 QSOP  |
| MAX4222 | 4           | No     | 14 SO, 16 QSOP  |

## Pin Configurations

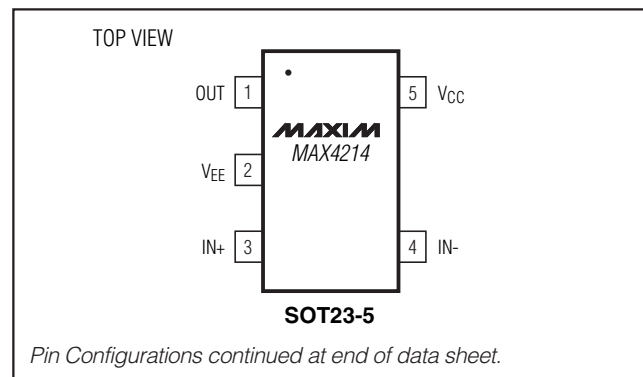

# High-Speed, Single-Supply, Gain of 2, Closed-Loop, Rail-to-Rail Buffers with Enable

## ABSOLUTE MAXIMUM RATINGS

|  |  |   |                 |
|--|--|---|-----------------|
| Supply Voltage ( $V_{CC}$ to $V_{EE}$ )                    | 12V  | 8-Pin $\mu$ MAX (derate 4.1mW/°C above +70°C) | 330mW           |
| $IN_-$ , $IN_+$ , $OUT_-$ , $EN_-$                         | ( $V_{EE} - 0.3V$ ) to ( $V_{CC} + 0.3V$ ) | 14-Pin SO (derate 8.3mW/°C above +70°C)       | 667mW           |
| Output Short-Circuit Duration to $V_{CC}$ or $V_{EE}$      | Continuous                                 | 16-Pin QSOP (derate 8.3mW/°C above +70°C)     | 667mW           |
| Continuous Power Dissipation ( $T_A = +70^\circ\text{C}$ ) |  | Operating Temperature Range                   | -40°C to +85°C  |
| 5-Pin SOT23 (derate 7.1mW/°C above +70°C)                  | 571mW                                      | Storage Temperature Range                     | -65°C to +150°C |
| 8-Pin SO (derate 5.9mW/°C above +70°C)                     | 471mW                                      | Lead Temperature (soldering, 10s)             | +300°C          |

Stresses beyond those listed under "Absolute Maximum Ratings" may cause permanent damage to the device. These are stress ratings only, and functional operation of the device at these or any other conditions beyond those indicated in the operational sections of the specifications is not implied. Exposure to absolute maximum rating conditions for extended periods may affect device reliability.

## DC ELECTRICAL CHARACTERISTICS

( $V_{CC} = 5V$ ,  $V_{EE} = 0$ ,  $IN_- = 0$ ,  $EN_- = 5V$ ,  $R_L = \infty$  to 0,  $V_{OUT} = V_{CC}/2$ , noninverting configuration,  $T_A = T_{MIN}$  to  $T_{MAX}$ , unless otherwise noted. Typical values are at  $T_A = +25^\circ\text{C}$ .) (Note 1)

| PARAMETER                             | SYMBOL         | CONDITIONS  |                              | MIN            | TYP            | MAX             | UNITS                        |
|---------------------------------------|----------------|---|------------------------------|----------------|----------------|-----------------|------------------------------|
| Operating Supply Voltage Range        |                | $V_{CC}$ to $V_{EE}$ , guaranteed by PSRR tests                               |                              | 3.15           |                | 11.0            | V                            |
| Input Voltage Range                   | $V_{IN}$       | $IN_+$  |                              | $V_{EE} - 0.1$ |                | $V_{CC} - 2.25$ | V                            |
|                                       |                | $IN_-$  |                              | $V_{EE} - 0.1$ |                | $V_{CC} + 0.1$  |                              |
| Input Offset Voltage                  | $V_{OS}$       | $R_L = 50\Omega$  | SO, QSOP                     |                | 4              | 10              | mV                           |
|                                       |                |   | SOT23-5, $\mu$ MAX           |                | 4              | 15              |                              |
| Input Offset Voltage Drift            | $TCV_{OS}$     |   |                              |                | 8              |                 | $\mu\text{V}/^\circ\text{C}$ |
| Input Offset Voltage Matching         |                | Between any two channels for MAX4217/MAX4219/MAX4222                          |                              |                | 1              |                 | mV                           |
| Input Bias Current                    | $I_B$          | $IN_+$  |                              |                | 5.4            | 12              | $\mu\text{A}$                |
| Input Resistance                      | $R_{IN}$       | $IN_+$ , over input voltage range   |                              |                | 3              |                 | $M\Omega$                    |
| Voltage Gain                          | $A_v$          | $R_L \geq 50\Omega$ , ( $V_{EE} + 0.5V$ ) $\leq V_{OUT} \leq (V_{CC} - 2.0V)$ |                              | 1.9            | 2              | 2.1             | V/V                          |
| Power-Supply Rejection Ratio (Note 2) | PSRR           | $V_{CC} = 5V$ , $V_{EE} = 0$ , $V_{OUT} = 2.0V$                               |                              | 55             | 58             |                 | dB                           |
|                                       |                | $V_{CC} = 5V$ , $V_{EE} = -5V$ , $V_{OUT} = 0$                                |                              | 60             | 66             |                 |                              |
|                                       |                | $V_{CC} = 3.3V$ , $V_{EE} = 0$ , $V_{OUT} = 0.90V$                            |                              |                | 45             |                 |                              |
| Output Resistance                     | $R_{OUT}$      | $f = \text{DC}$   |                              |                | 25             |                 | $m\Omega$                    |
| Output Current                        | $I_{OUT}$      | $R_L = 20\Omega$ to $V_{CC}$ or $V_{EE}$                                      | $T_A = +25^\circ\text{C}$    | $\pm 70$       | $\pm 120$      |                 | mA                           |
|                                       |                |   | $T_A = T_{MIN}$ to $T_{MAX}$ | $\pm 60$       |                |                 |                              |
| Short-Circuit Output Current          | $I_{SC}$       | Sinking or sourcing   |                              |                | $\pm 150$      |                 | mA                           |
| Output Voltage Swing                  | $V_{OUT}$      | $R_L = 50\Omega$  | $V_{CC} - V_{OH}$            |                | 1.60           | 1.90            | V                            |
|                                       |                |   | $V_{OL} - V_{EE}$            |                | 0.04           | 0.075           |                              |
|                                       |                | $R_L = 150\Omega$   | $V_{CC} - V_{OH}$            |                | 0.75           | 1.00            |                              |
|                                       |                |   | $V_{OL} - V_{EE}$            |                | 0.04           | 0.075           |                              |
|                                       |                | $R_L = 2k\Omega$  | $V_{CC} - V_{OH}$            |                | 0.06           |                 |                              |
|                                       |                |   | $V_{OL} - V_{EE}$            |                | 0.06           |                 |                              |
| Disabled Output Resistance            | $R_{OUT(OFF)}$ | MAX4215/MAX4219, $EN_- = 0$ , $0 \leq V_{OUT} \leq 5V$                        |                              |                | 1              |                 | $k\Omega$                    |
| $EN_-$ Logic Low Threshold            | $V_{IL}$       | MAX4215/MAX4219   |                              |                | $V_{CC} - 2.6$ |                 | V                            |
| $EN_-$ Logic High Threshold           | $V_{IH}$       | MAX4215/MAX4219   |                              | $V_{CC} - 1.6$ |                |                 | V                            |

# High-Speed, Single-Supply, Gain of 2, Closed-Loop, Rail-to-Rail Buffers with Enable

MAX4214/MAX4215/MAX4217/MAX4219/MAX4222

## DC ELECTRICAL CHARACTERISTICS (continued)

( $V_{CC} = 5V$ ,  $V_{EE} = 0$ ,  $I_{N-} = 0$ ,  $E_{N-} = 5V$ ,  $R_L = \infty$  to  $0$ ,  $V_{OUT} = V_{CC}/2$ , noninverting configuration,  $T_A = T_{MIN}$  to  $T_{MAX}$ , unless otherwise noted. Typical values are at  $T_A = +25^\circ C$ .) (Note 1)

| PARAMETER                             | SYMBOL   | CONDITIONS   | MIN | TYP | MAX | UNITS   |
|---------------------------------------|----------|--|-----|-----|-----|---------|
| EN_ Logic Input Low Current           | $I_{IL}$ | $\text{MAX4215/MAX4219, } (V_{EE} + 0.2V) \leq E_{N-} \leq V_{CC}$ |     | 0.5 |     | $\mu A$ |
|                                       |          | $\text{MAX4215/MAX4219, } E_{N-} = V_{EE}$                         |     | 200 | 350 |         |
| EN_ Logic Input High Current          | $I_{IH}$ | $\text{MAX4215/MAX4219, } E_{N-} = V_{CC}$                         |     | 0.5 | 10  | $\mu A$ |
| Quiescent Supply Current (per Buffer) | $I_{CC}$ |  |     | 5.5 | 7.0 | mA      |
| Shutdown Supply Current               | $I_{SD}$ | $\text{MAX4215/MAX4219, disabled } (E_{N-} = V_{EE})$              |     | 400 | 550 | $\mu A$ |

**Note 1:** The MAX421\_EU\_ is 100% production tested at  $T_A = 25^\circ C$ . Specifications over temperature limits are guaranteed by design.

**Note 2:** PSRR for single 5V supply tested with  $V_{EE} = 0$ ,  $V_{CC} = 4.5V$  to  $5.5V$ ; for dual  $\pm 5V$  supply with  $V_{EE} = -4.5V$  to  $-5.5V$ ,  $V_{CC} = 4.5V$  to  $5.5V$ ; and for single 3V supply with  $V_{EE} = 0$ ,  $V_{CC} = 3.15V$  to  $3.45V$ .

## AC ELECTRICAL CHARACTERISTICS

( $V_{CC} = 5V$ ,  $V_{EE} = 0$ ,  $I_{N-} = 0$ ,  $E_{N-} = 5V$ ,  $R_L = 100\Omega$  to  $V_{CC}/2$ , noninverting configuration,  $T_A = T_{MIN}$  to  $T_{MAX}$ , unless otherwise noted. Typical values are at  $T_A = +25^\circ C$ .)

| PARAMETER                         | SYMBOL         | CONDITIONS                            |                                  | MIN | TYP  | MAX | UNITS          |
|-----------------------------------|----------------|---------------------------------------|----------------------------------|-----|------|-----|----------------|
| Small-Signal -3dB Bandwidth       | $BW_{-3dB}$    | $V_{OUT} = 100mV_{P-P}$               | $\text{MAX4214/MAX4215/MAX4217}$ |     | 230  |     | MHz            |
|                                   |                |                                       | $\text{MAX4219/MAX4222}$         |     | 200  |     |                |
| Full-Power -3dB Bandwidth         | FPBW           | $V_{OUT} = 2V_{P-P}$                  | $\text{MAX4214/MAX4215/MAX4217}$ |     | 220  |     | MHz            |
|                                   |                |                                       | $\text{MAX4219/MAX4222}$         |     | 200  |     |                |
| Bandwidth for 0.1dB Gain Flatness | $BW_{0.1dB}$   | $V_{OUT} = 100mV_{P-P}$               | $\text{MAX4214/MAX4215/MAX4217}$ |     | 50   |     | MHz            |
|                                   |                |                                       | $\text{MAX4219/MAX4222}$         |     | 90   |     |                |
| Slew Rate                         | SR             | $V_{OUT} = 2V$ step                   |                                  |     | 600  |     | $V/\mu s$      |
| Settling Time to 0.1%             | $t_S$          | $V_{OUT} = 2V$ step                   |                                  |     | 45   |     | ns             |
| Rise/Fall Time                    | $t_R, t_F$     | $V_{OUT} = 100mV_{P-P}$               |                                  |     | 1    |     | ns             |
| Spurious-Free Dynamic Range       | SFDR           | $f_C = 5MHz, V_{OUT} = 2V_{P-P}$      |                                  |     | -72  |     | dBc            |
| Harmonic Distortion               | HD             | $V_{OUT} = 2V_{P-P}, f_C = 5MHz$      | Second harmonic                  |     | -72  |     | dBc            |
|                                   |                |                                       | Third harmonic                   |     | -77  |     |                |
|                                   |                |                                       | Total harmonic distortion        |     | -71  |     |                |
| Third-Order Intercept             | IP3            | $f = 10MHz$                           |                                  |     | 35   |     | dBm            |
| Input 1dB Compression Point       |                | $f = 10MHz$                           |                                  |     | 11   |     | dBm            |
| Differential Phase Error          | DP             | NTSC, $R_L = 150\Omega$               |                                  |     | 0.04 |     | degrees        |
| Differential Gain Error           | DG             | NTSC, $R_L = 150\Omega$               |                                  |     | 0.03 |     | %              |
| Input Noise-Voltage Density       | $e_n$          | $f = 10kHz$                           |                                  |     | 10   |     | $nV/\sqrt{Hz}$ |
| Input Noise-Current Density       | $i_n$          | $f = 10kHz$                           |                                  |     | 1.3  |     | $pA/\sqrt{Hz}$ |
| Input Capacitance                 | $C_{IN}$       |                                       |                                  |     | 1    |     | pF             |
| Disabled Output Capacitance       | $C_{OUT(OFF)}$ | $\text{MAX4215/MAX4219, } E_{N-} = 0$ |                                  |     | 2    |     | pF             |

# High-Speed, Single-Supply, Gain of 2, Closed-Loop, Rail-to-Rail Buffers with Enable

## AC ELECTRICAL CHARACTERISTICS (continued)

( $V_{CC} = 5V$ ,  $V_{EE} = 0$ ,  $IN_- = 0$ ,  $EN_- = 5V$ ,  $R_L = 100\Omega$  to  $V_{CC}/2$ , noninverting configuration,  $T_A = T_{MIN}$  to  $T_{MAX}$ , unless otherwise noted. Typical values are at  $T_A = +25^\circ C$ .)

| PARAMETER             | SYMBOL    | CONDITIONS   | MIN | TYP | MAX | UNITS     |
|-----------------------|-----------|--|-----|-----|-----|-----------|
| Output Impedance      | $Z_{OUT}$ | $f = 10MHz$  |     | 200 |     | $m\Omega$ |
| Buffer Enable Time    | $t_{ON}$  | MAX4215/MAX4219  |     | 100 |     | ns        |
| Buffer Disable Time   | $t_{OFF}$ | MAX4215/MAX4219  |     | 1   |     | $\mu s$   |
| Buffer Gain Matching  |           | MAX4217/MAX4219/MAX4222, $f = 10MHz$ , $V_{OUT} = 100mV_{P-P}$ |     | 0.1 |     | dB        |
| All-Hostile Crosstalk | XTALK     | MAX4217/MAX4219/MAX4222, $f = 10MHz$ , $V_{OUT} = 2V_{P-P}$    |     | -95 |     | dB        |

## Typical Operating Characteristics

( $V_{CC} = 5V$ ,  $V_{EE} = 0$ ,  $A_{VCL} = 2V/V$ ,  $R_L = 100\Omega$  to  $V_{CC}/2$ ,  $T_A = +25^\circ C$ , unless otherwise noted.)

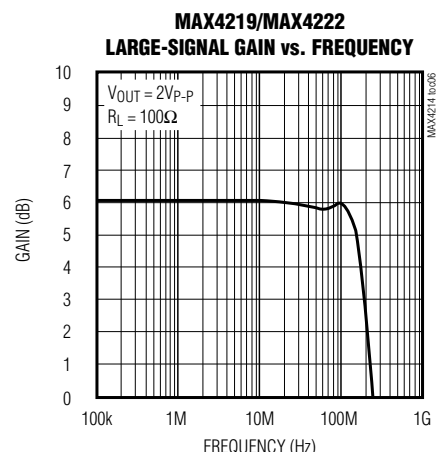
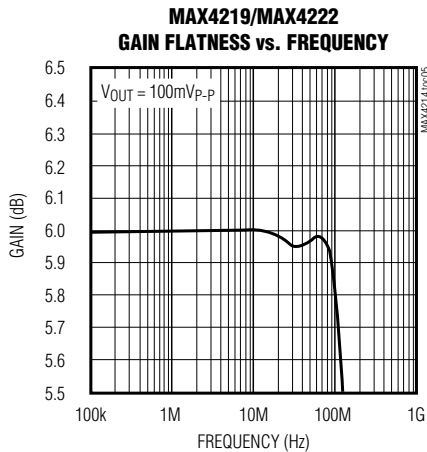
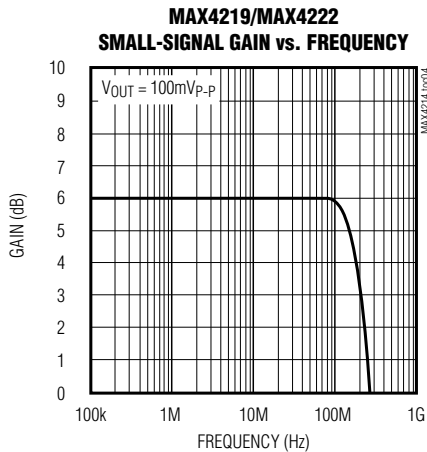
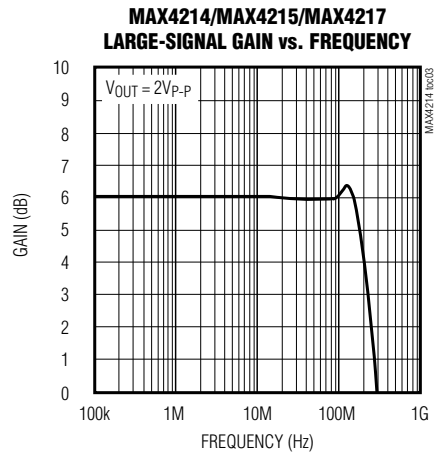
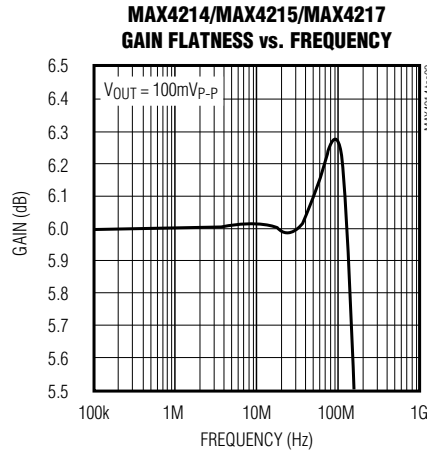
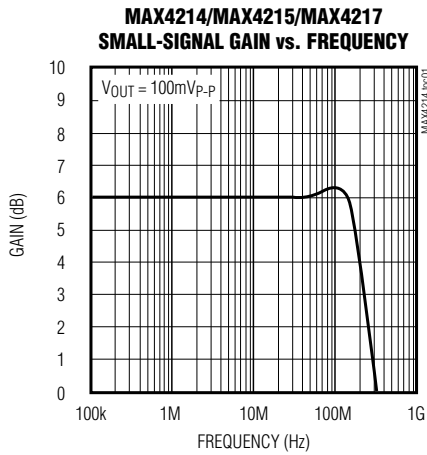

# High-Speed, Single-Supply, Gain of 2, Closed-Loop, Rail-to-Rail Buffers with Enable

## Typical Operating Characteristics (continued)

( $V_{CC} = 5V$ ,  $V_{EE} = 0$ ,  $A_{VCL} = 2V/V$ ,  $R_L = 100\Omega$  to  $V_{CC}/2$ ,  $T_A = +25^\circ C$ , unless otherwise noted.)

MAX4214/MAX4215/MAX4217/MAX4219/MAX4222

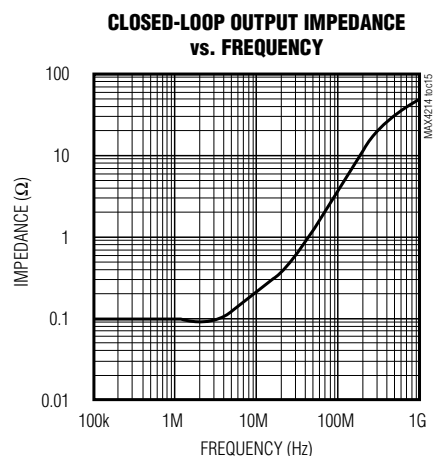
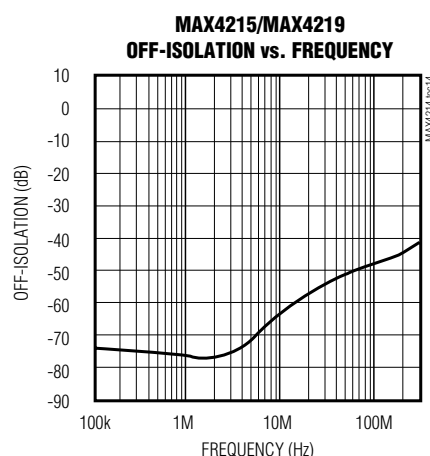
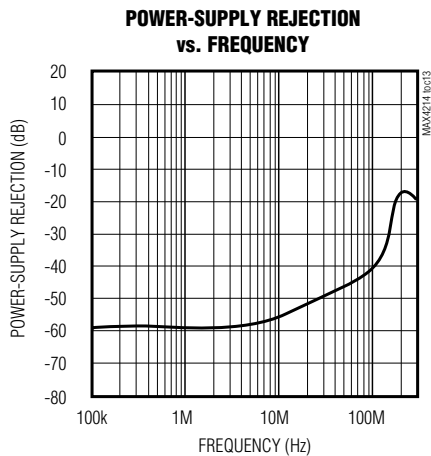
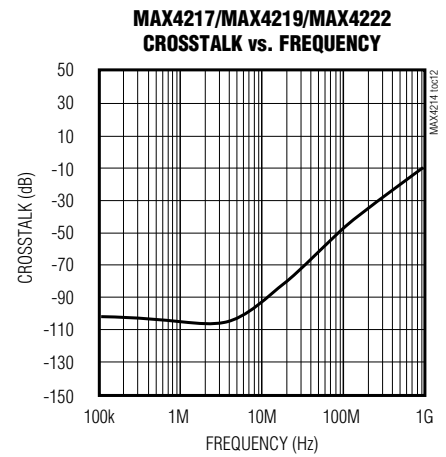
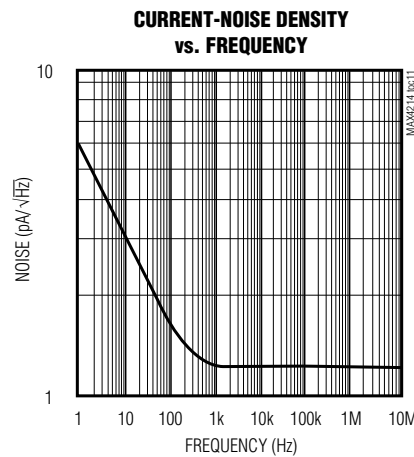
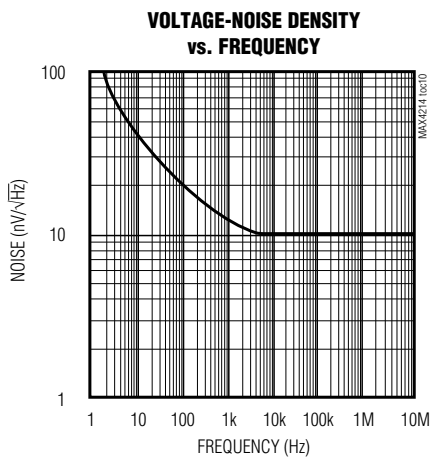
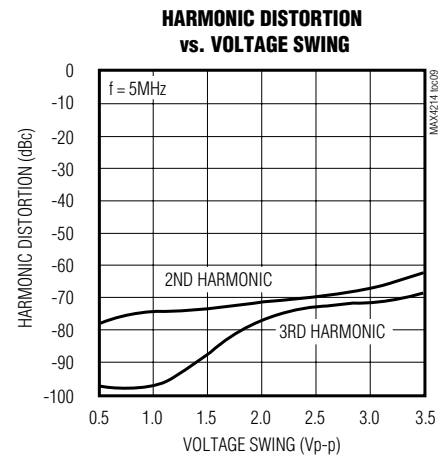
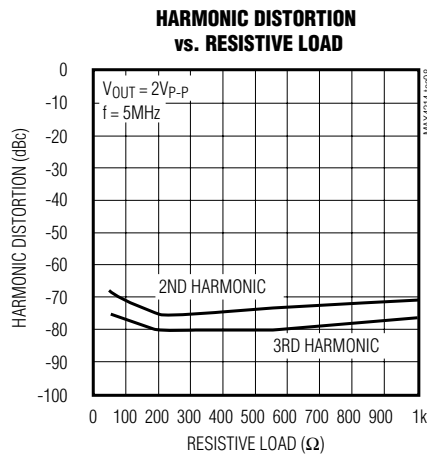
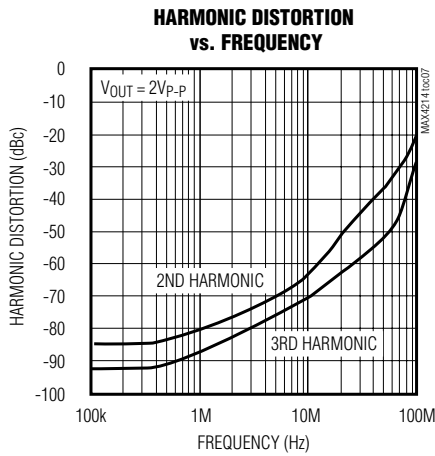

# High-Speed, Single-Supply, Gain of 2, Closed-Loop, Rail-to-Rail Buffers with Enable

## Typical Operating Characteristics (continued)

( $V_{CC} = 5V$ ,  $V_{EE} = 0$ ,  $A_{VCL} = 2V/V$ ,  $R_L = 100\Omega$  to  $V_{CC}/2$ ,  $T_A = +25^\circ C$ , unless otherwise noted.)

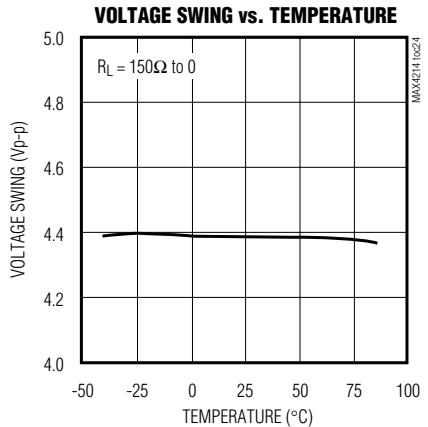
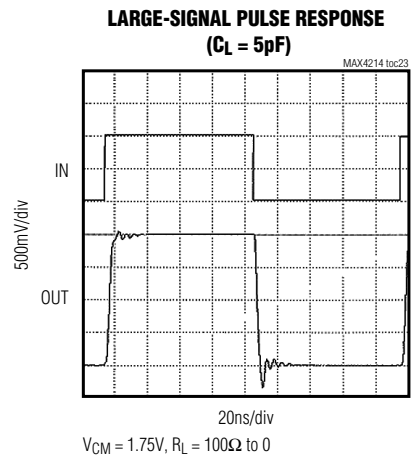
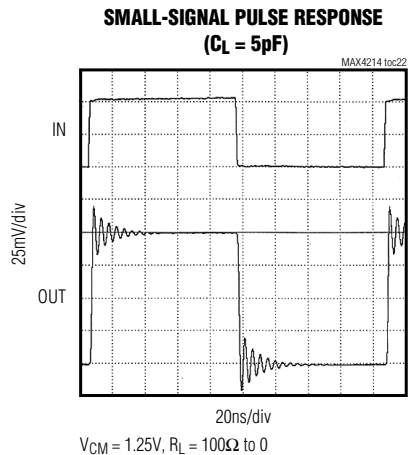
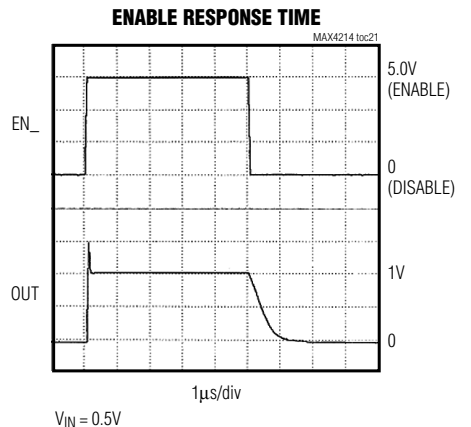
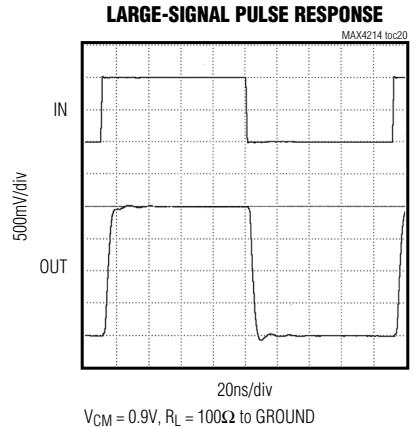
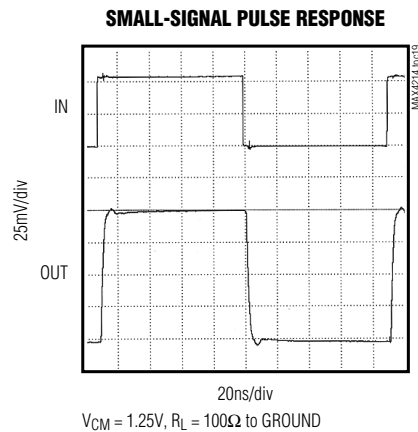
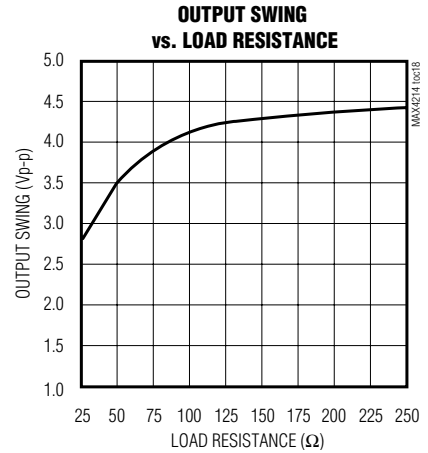
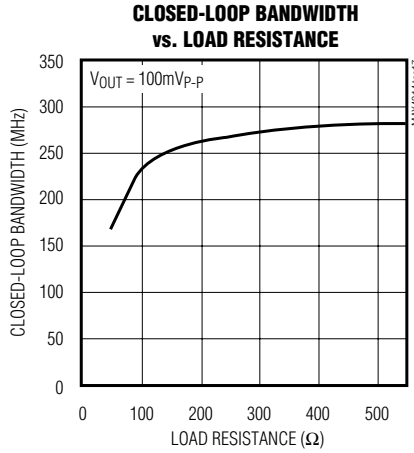
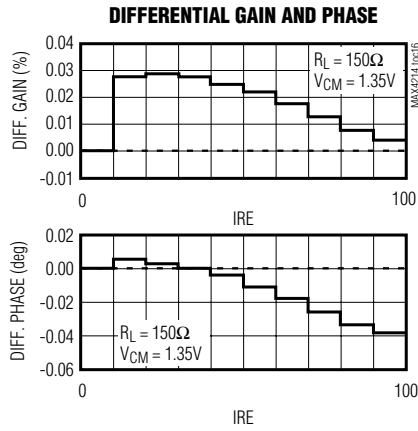

# High-Speed, Single-Supply, Gain of 2, Closed-Loop, Rail-to-Rail Buffers with Enable

## Typical Operating Characteristics (continued)

( $V_{CC} = 5V$ ,  $V_{EE} = 0$ ,  $A_{vCL} = 2V/V$ ,  $R_L = 100\Omega$  to  $V_{CC}/2$ ,  $T_A = +25^\circ C$ , unless otherwise noted.)

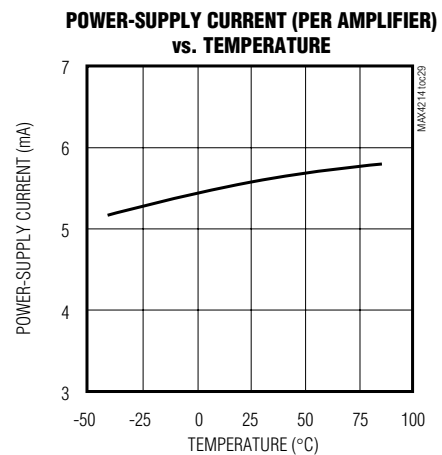
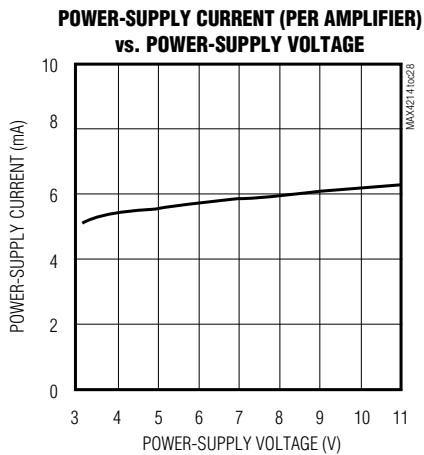
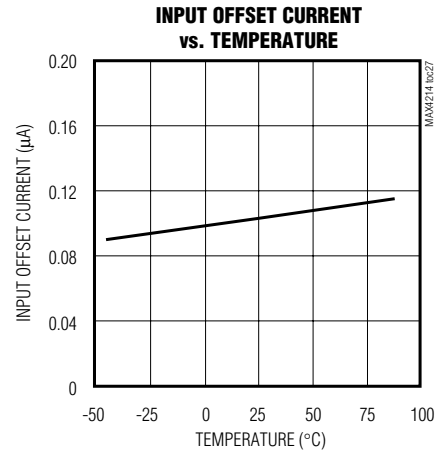
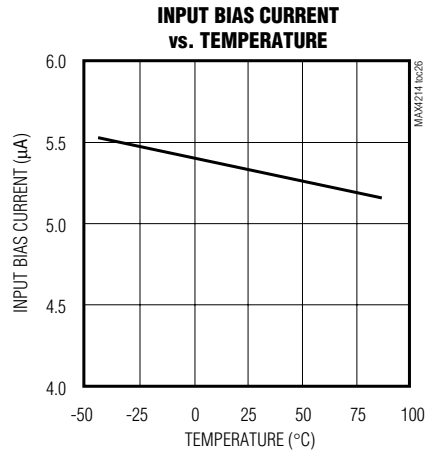
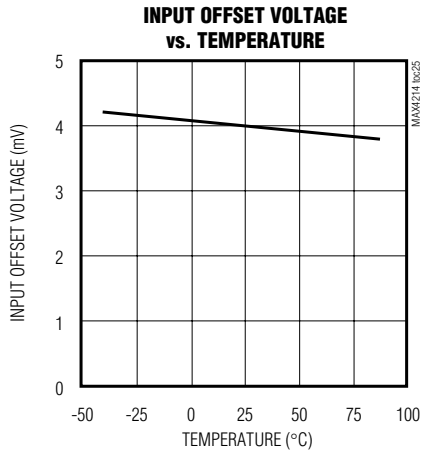

MAX4214/MAX4215/MAX4217/MAX4219/MAX4222

# High-Speed, Single-Supply, Gain of 2, Closed-Loop, Rail-to-Rail Buffers with Enable

## Pin Description

| PIN     |               |               |         |      |         |      | NAME            | FUNCTION  |
|---------|---------------|---------------|---------|------|---------|------|-----------------|---|
| MAX4214 | MAX4215       | MAX4217       | MAX4219 |      | MAX4222 |      |                 |   |
| SOT23-5 | SO/ $\mu$ MAX | SO/ $\mu$ MAX | SO      | QSOP | SO      | QSOP |                 |   |
| —       | 1,5           | —             | —       | 8,9  | —       | 8,9  | N.C.            | No Connection. Not internally connected. Tie to ground or leave open. |
| 1       | 6             | —             | —       | —    | —       | —    | OUT             | Amplifier Output  |
| 2       | 4             | 4             | 11      | 13   | 11      | 13   | V <sub>EE</sub> | Negative Power Supply or Ground (in single-supply operation)          |
| 3       | 3             | —             | —       | —    | —       | —    | IN+             | Noninverting Input  |
| 4       | 2             | —             | —       | —    | —       | —    | IN-             | Inverting Input   |
| 5       | 7             | 8             | 4       | 4    | 4       | 4    | V <sub>CC</sub> | Positive Power Supply   |
| —       | 8             | —             | —       | —    | —       | —    | EN              | Enable Amplifier  |
| —       | —             | —             | 1       | 1    | —       | —    | ENA             | Enable Amplifier A  |
| —       | —             | —             | 3       | 3    | —       | —    | ENB             | Enable Amplifier B  |
| —       | —             | —             | 2       | 2    | —       | —    | ENC             | Enable Amplifier C  |
| —       | —             | 1             | 7       | 7    | 1       | 1    | OUTA            | Amplifier A Output  |
| —       | —             | 2             | 6       | 6    | 2       | 2    | INA-            | Amplifier A Inverting Input   |
| —       | —             | 3             | 5       | 5    | 3       | 3    | INA+            | Amplifier A Noninverting Input  |
| —       | —             | 7             | 8       | 10   | 7       | 7    | OUTB            | Amplifier B Output  |
| —       | —             | 6             | 9       | 11   | 6       | 6    | INB-            | Amplifier B Inverting Input   |
| —       | —             | 5             | 10      | 12   | 5       | 5    | INB+            | Amplifier B Noninverting Input  |
| —       | —             | —             | 14      | 16   | 8       | 10   | OUTC            | Amplifier C Output  |
| —       | —             | —             | 13      | 15   | 9       | 11   | INC-            | Amplifier C Inverting Input   |
| —       | —             | —             | 12      | 14   | 10      | 12   | INC+            | Amplifier C Noninverting Input  |
| —       | —             | —             | —       | —    | 14      | 16   | OUTD            | Amplifier D Output  |
| —       | —             | —             | —       | —    | 13      | 15   | IND-            | Amplifier D Inverting Input   |
| —       | —             | —             | —       | —    | 12      | 14   | IND+            | Amplifier D Noninverting Input  |

MAX4214/MAX4215/MAX4217/MAX4219/MAX4222



# High-Speed, Single-Supply, Gain of 2, Closed-Loop, Rail-to-Rail Buffers with Enable

MAX4214/MAX4215/MAX4217/MAX4219/MAX4222

## Detailed Description

The MAX4214/MAX4215/MAX4217/MAX4219/MAX4222 are single-supply, rail-to-rail output, voltage-feedback, closed-loop buffers that employ current-feedback techniques to achieve 600V/ $\mu$ s slew rates and 230MHz bandwidths. These buffers use internal 500 $\Omega$  resistors to provide a preset closed-loop gain of 2V/V in the noninverting configuration or -1V/V in the inverting configuration. Excellent harmonic distortion and differential gain/phase performance make them an ideal choice for a wide variety of video and RF signal-processing applications.

Local feedback around the buffer's output stage ensures low output impedance, which reduces gain sensitivity to load variations. This feedback also produces demand-driven current bias to the output transistors for  $\pm$ 120mA drive capability, while constraining total supply current to less than 7mA.

## Applications Information

### Power Supplies

These devices operate from a single 3.15V to 11V power supply or from dual supplies of  $\pm$ 1.575V to  $\pm$ 5.5V. For single-supply operation, bypass the VCC pin to ground with a 0.1 $\mu$ F capacitor as close to the pin as possible. If operating with dual supplies, bypass each supply with a 0.1 $\mu$ F capacitor.

### Selecting Gain Configuration

Each buffer in the MAX4214 family can be configured for a voltage gain of 2V/V or -1V/V. For a gain of 2V/V, ground the inverting terminal. Use the noninverting terminal as the signal input of the buffer (Figure 1a). Grounding the noninverting terminal and using the inverting terminal as the signal input configures the buffer for a gain of -1V/V (Figure 1b).

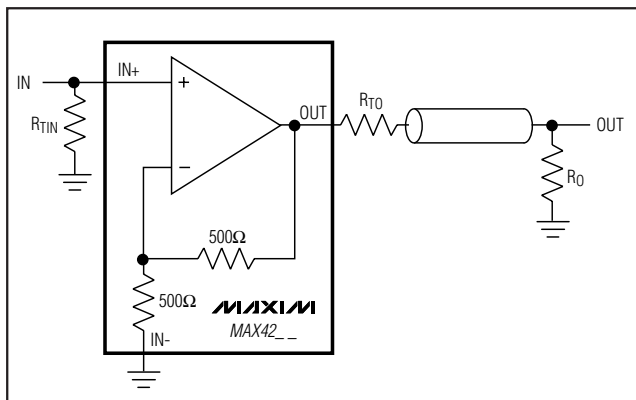

Figure 1a. Noninverting Gain Configuration ( $A_V = +2V/V$ )

Since the inverting input exhibits a 500 $\Omega$  input impedance, terminate the input with a 56 $\Omega$  resistor when configured for an inverting gain in 50 $\Omega$  applications (terminate with 88 $\Omega$  in 75 $\Omega$  applications). Terminate the input with a 49.9 $\Omega$  resistor in the noninverting case. Output terminating resistors should directly match cable impedances in either configuration.

### Layout Techniques

Maxim recommends using microstrip and stripline techniques to obtain full bandwidth. To ensure the PC board does not degrade the buffer's performance, design it for a frequency greater than 1GHz. Pay careful attention to inputs and outputs to avoid large parasitic capacitance. Whether or not you use a constant-impedance board, observe the following guidelines when designing the board:

- Don't use wire-wrapped boards. They are too inductive.
- Don't use IC sockets. They increase parasitic capacitance and inductance.
- Use surface-mount instead of through-hole components for better high-frequency performance.
- Use a PC board with at least two layers; it should be as free from voids as possible.
- Keep signal lines as short and as straight as possible. Do not make 90° turns; round all corners.

### Input Voltage Range and Output Swing

The MAX4214 family's input range extends from (V<sub>EE</sub> - 100mV) to (V<sub>CC</sub> - 2.25V). Input ground sensing increases the dynamic range for single-supply applications. The outputs drive a 2k $\Omega$  load to within 60mV of the power-supply rails. With smaller resistive loads, the output swing is reduced as shown in the *Electrical Characteristics* and *Typical Operating Characteristics*.

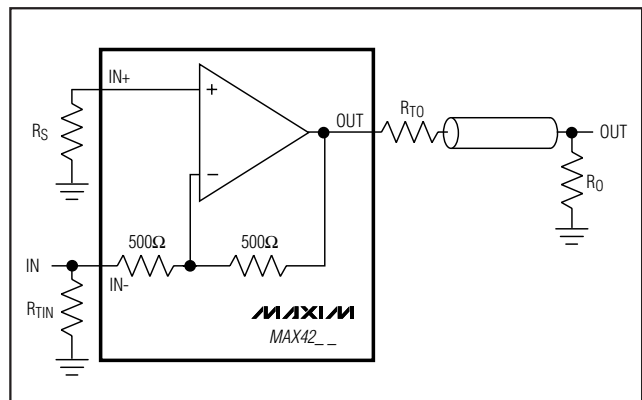

Figure 1b. Inverting Gain Configuration ( $A_V = -1V/V$ )

# High-Speed, Single-Supply, Gain of 2, Closed-Loop, Rail-to-Rail Buffers with Enable

As the load resistance decreases, the useful input range is effectively limited by the output drive capability, since the buffers have a fixed voltage gain of 2V/V or -1V/V.

For example, a 50Ω load can typically be driven from 40mV above V<sub>EE</sub> to 1.6V below V<sub>CC</sub>, or 40mV to 3.4V when operating from a single 5V supply. If the buffer is operated in the noninverting, gain of 2V/V configuration with the inverting input grounded, the useful input voltage range becomes 20mV to 1.7V instead of the -100mV to 2.75V indicated by the *Electrical Characteristics*. Beyond the useful input range, the buffer output is a nonlinear function of the input, but it will not undergo phase reversal or latchup.

### Enable

The MAX4215/MAX4219 have an enable feature (EN<sub>-</sub>) that allows the buffer to be placed in a low-power state. When the buffers are disabled, the supply current is reduced to 400μA per buffer.

As the voltage at the EN<sub>-</sub> pin approaches the negative supply rail, the EN<sub>-</sub> input current rises. Figure 2 shows a graph of EN<sub>-</sub> input current versus EN<sub>-</sub> pin voltage. Figure 3 shows the addition of an optional resistor in series with the EN pin, to limit the magnitude of the current increase. Figure 4 displays the resulting EN pin input current to voltage relationship.

### Disabled Output Resistance

The MAX4214/MAX4215/MAX4217/MAX4219/MAX4222 include internal protection circuitry that prevents damage to the precision input stage from large differential input voltages (Figure 5). This protection circuitry con-

sists of five back-to-back Schottky diodes between IN<sub>+</sub> and IN<sub>-</sub>. These diodes reduce the disabled output resistance from 1kΩ to 500Ω when the output voltage is 3V greater or less than the voltage at IN<sub>+</sub>. Under these conditions, the input protection diodes will be forward biased, lowering the disabled output resistance to 500Ω.

### Output Capacitive Loading and Stability

The MAX4214 family provides maximum AC performance with no load capacitance. This is the case when the load is a properly terminated transmission line. These devices are designed to drive up to 20pF of load capacitance without oscillating, but AC performance will be reduced under these conditions.

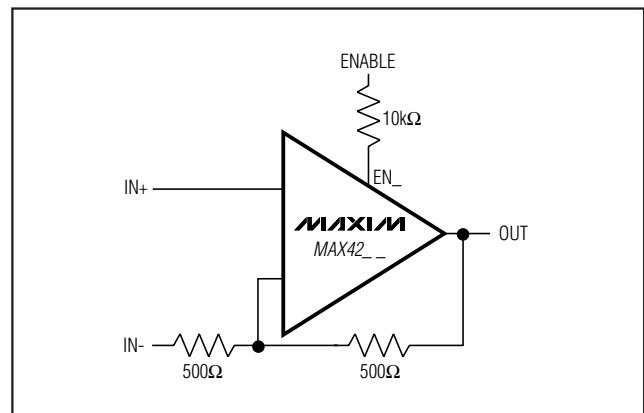

Figure 3. Circuit to Reduce Enable Logic-Low Input Current

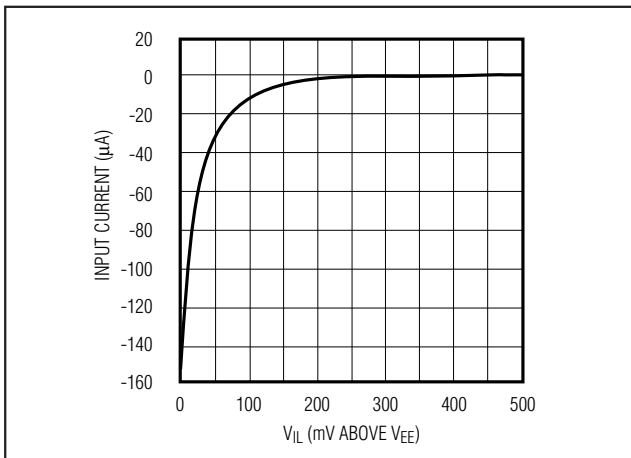

Figure 2. Enable Logic-Low Input Current vs. Enable Logic-Low Threshold

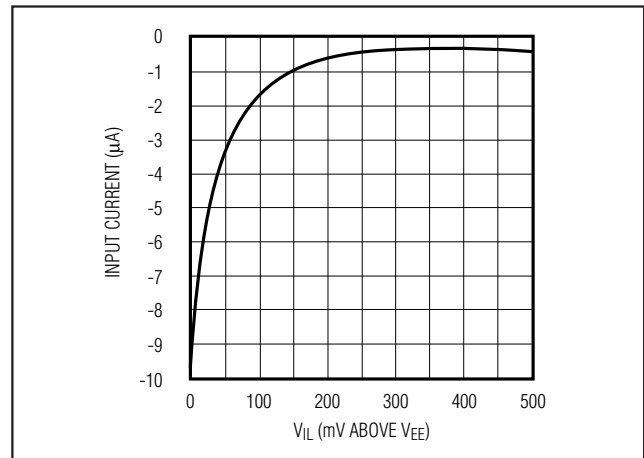

Figure 4. Enable Logic-Low Input Current vs. Enable Logic-Low Threshold with 10kΩ Series Resistor

# High-Speed, Single-Supply, Gain of 2, Closed-Loop, Rail-to-Rail Buffers with Enable

MAX4214/MAX4215/MAX4217/MAX4219/MAX4222

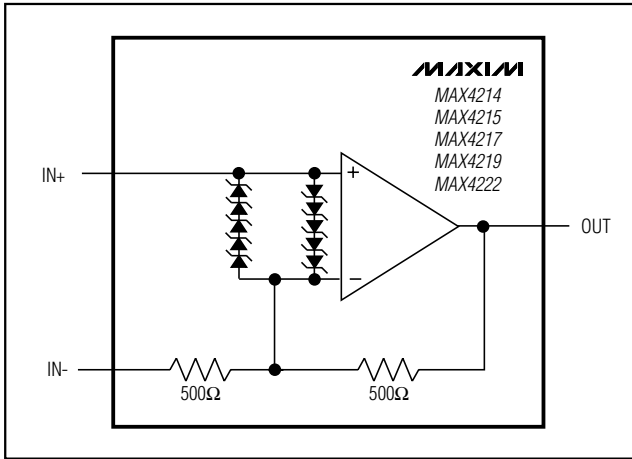

Figure 5. Input Protection Circuit

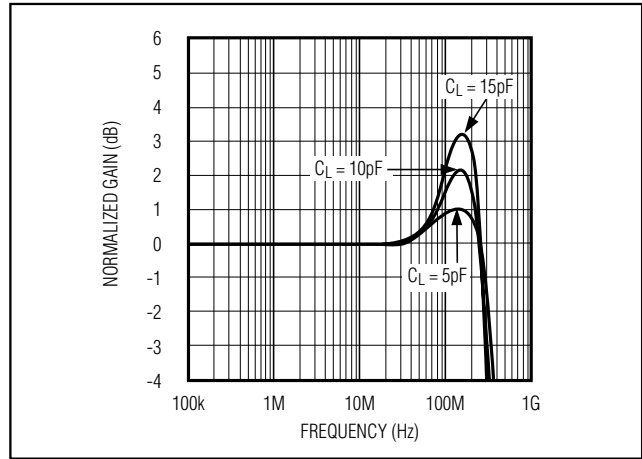

Figure 6. Small-Signal Gain vs. Frequency with Load Capacitance and No Isolation Resistor

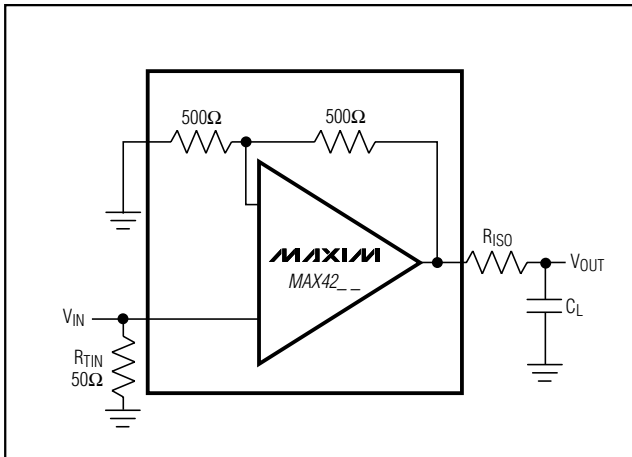

Figure 7. Driving a Capacitive Load Through an Isolation Resistor

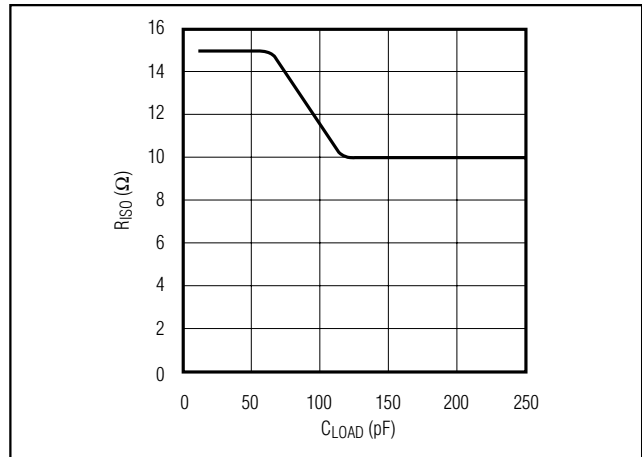

Figure 8. Isolation Resistance vs. Capacitive Load

Driving large capacitive loads increases the chance of oscillations occurring in most amplifier circuits. This is especially true for circuits with high loop gains, such as voltage followers. The buffer's output resistance and the load capacitor combine to add a pole and excess phase to the loop response. If the frequency of this pole is low enough to interfere with the loop response and degrade phase margin sufficiently, oscillations can occur.

A second problem when driving capacitive loads results from the amplifier's output impedance, which looks inductive at high frequencies. This inductance forms an L-C resonant circuit with the capacitive load, which causes peaking in the frequency response and degrades the amplifier's gain margin.

Figure 6 shows the devices' frequency response under different capacitive loads. To drive loads with greater than 20pF of capacitance or to settle out some of the peaking, the output requires an isolation resistor like the one shown in Figure 7. Figure 8 is a graph of the Optimal Isolation Resistor vs. Load Capacitance. Figure 9 shows the frequency response of the MAX4214/MAX4215/MAX4217/MAX4219/MAX4222 when driving capacitive loads with a 27Ω isolation resistor.

Coaxial cables and other transmission lines are easily driven when properly terminated at both ends with their characteristic impedance. Driving back-terminated transmission lines essentially eliminates the lines' capacitance.

# High-Speed, Single-Supply, Gain of 2, Closed-Loop, Rail-to-Rail Buffers with Enable

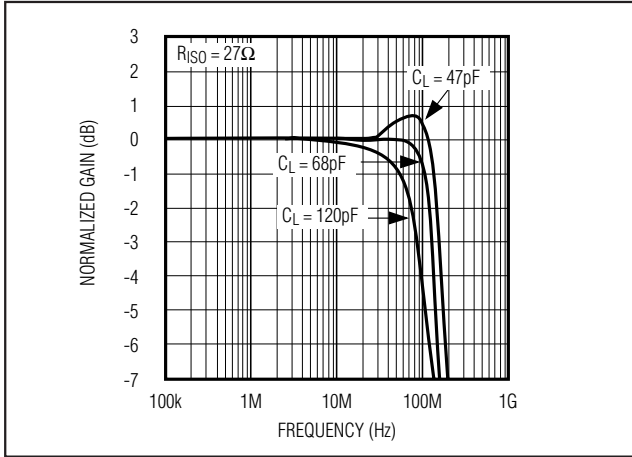
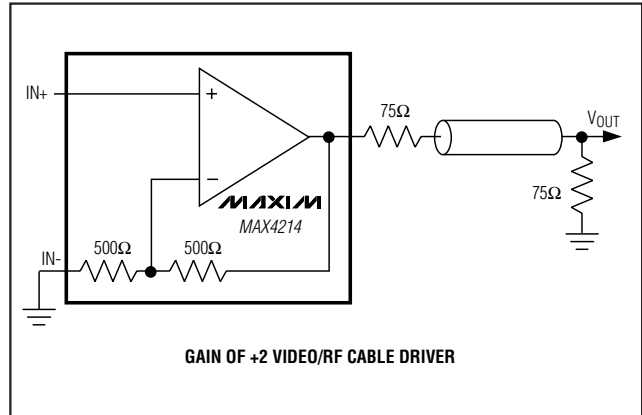

Figure 9. Small-Signal Gain vs. Frequency with Load Capacitance and 27Ω Isolation Resistor

## Typical Application Circuit



## Chip Information

- MAX4214 TRANSISTOR COUNT: 95
- MAX4215 TRANSISTOR COUNT: 95
- MAX4217 TRANSISTOR COUNT: 190
- MAX4219 TRANSISTOR COUNT: 299
- MAX4222 TRANSISTOR COUNT: 362
- SUBSTRATE CONNECTED TO V<sub>EE</sub>

# High-Speed, Single-Supply, Gain of 2, Closed-Loop, Rail-to-Rail Buffers with Enable

## Pin Configurations (continued)

MAX4214/MAX4215/MAX4217/MAX4219/MAX4222

TOP VIEW

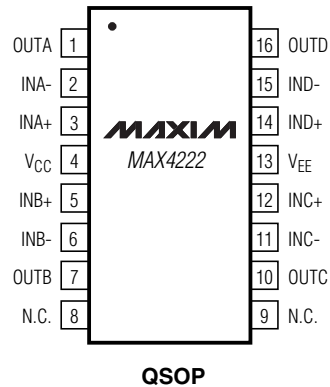
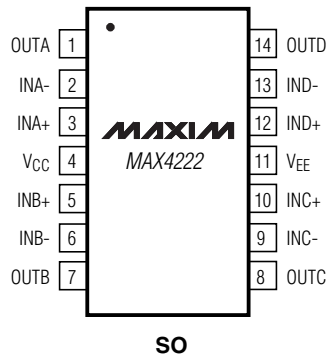
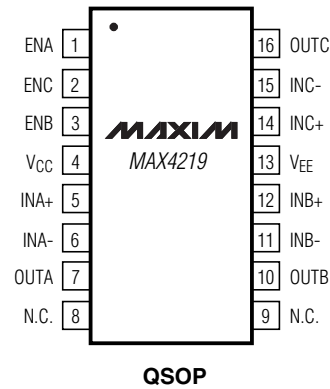
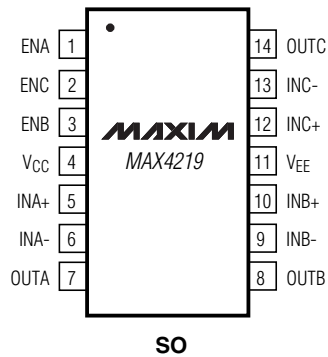
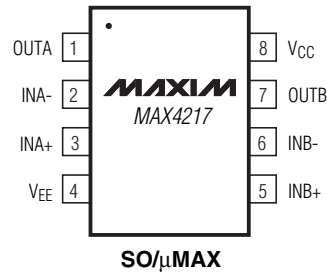
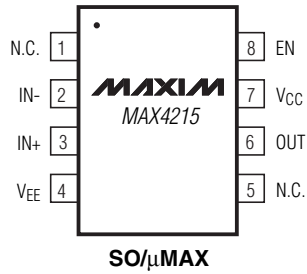

# High-Speed, Single-Supply, Gain of 2, Closed-Loop, Rail-to-Rail Buffers with Enable

## Tape-and-Reel Information

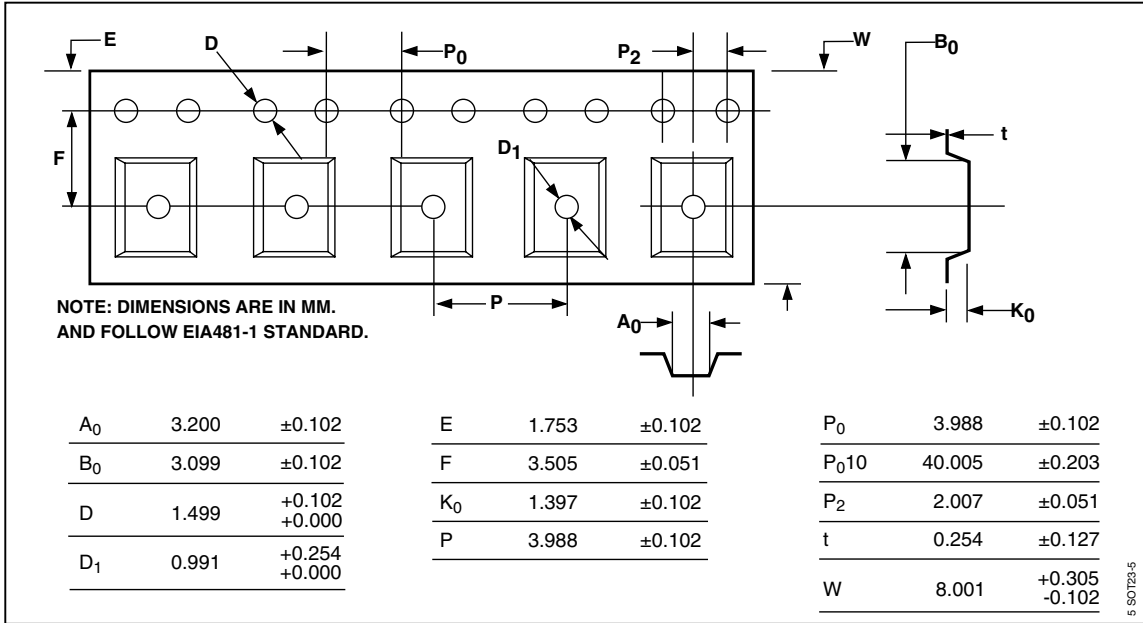

## Package Information

(The package drawing(s) in this data sheet may not reflect the most current specifications. For the latest package outline information, go to [www.maxim-ic.com/packages](http://www.maxim-ic.com/packages).)

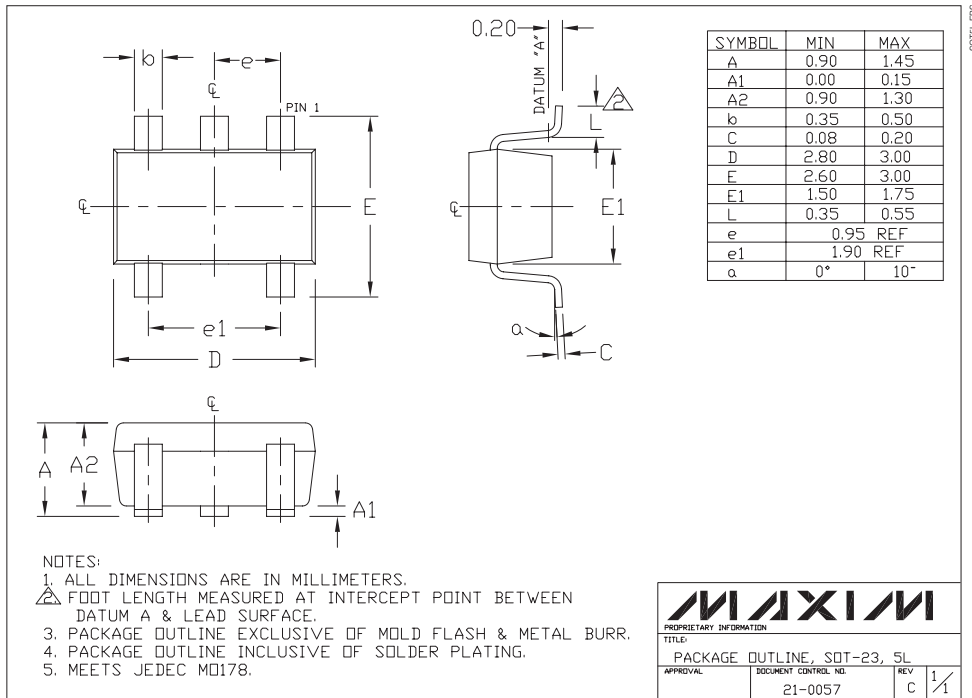

# High-Speed, Single-Supply, Gain of 2, Closed-Loop, Rail-to-Rail Buffers with Enable

## Package Information (continued)

(The package drawing(s) in this data sheet may not reflect the most current specifications. For the latest package outline information, go to [www.maxim-ic.com/packages](http://www.maxim-ic.com/packages).)

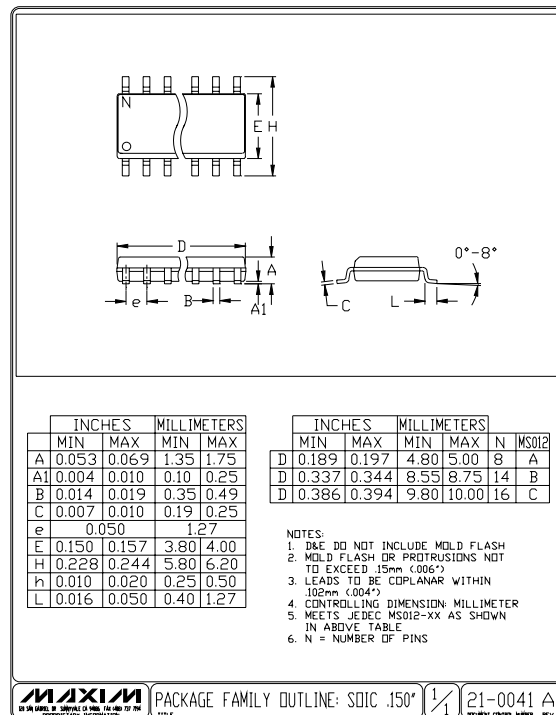
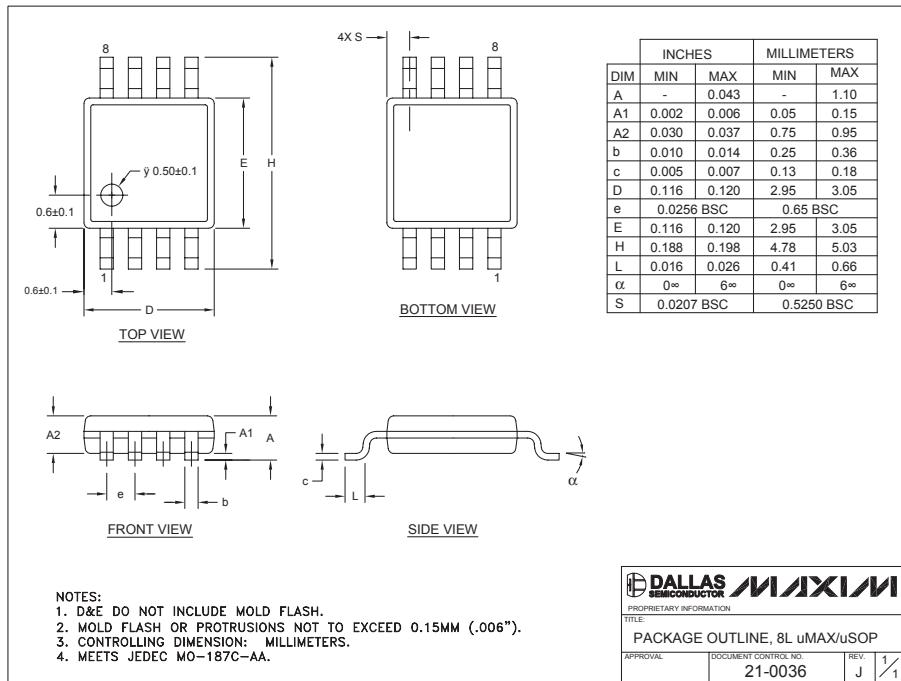

# High-Speed, Single-Supply, Gain of 2, Closed-Loop, Rail-to-Rail Buffers with Enable

## Package Information (continued)

(The package drawing(s) in this data sheet may not reflect the most current specifications. For the latest package outline information, go to [www.maxim-ic.com/packages](http://www.maxim-ic.com/packages).)

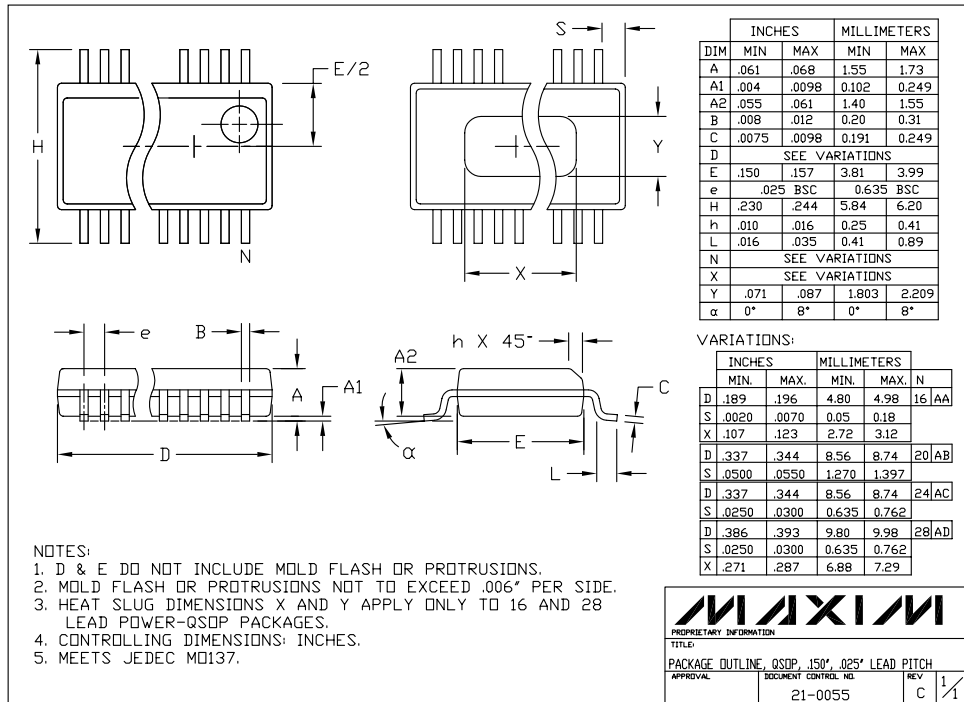

QSDP-EPS

Maxim cannot assume responsibility for use of any circuitry other than circuitry entirely embodied in a Maxim product. No circuit patent licenses are implied. Maxim reserves the right to change the circuitry and specifications without notice at any time.