



Single/Dual/Quad High-Speed, Fast-Settling, High Output Current Operational Amplifier

MAX408/428/448

General Description

The MAX408/428/448 are high speed general purpose monolithic operational amplifiers in a single, dual or quad package, that are useful for signal frequencies extending into the video range. These Op Amps function in gain configurations greater-than or equal-to 3. High output current allows large capacitive loads to be driven at high speeds.

Open-loop voltage gain of 10k V/V and high slew rate of 90V/μs make the MAX408/428/448 ideal for analog amplification and high speed signal processing. 100MHz gain bandwidth and a ±0.1% settling time of 150ns make each amplifier ideal for fast data conversion systems.

The amplifiers are capable of driving back terminated transmission lines of 75Ω with amplitudes of 5V peak-to-peak.

Along with the high speed and output drive capability, a 35nA offset current and trimmable offset voltage make the MAX408/428/448 optimal for signal conditioning applications where accuracy must be maintained.

Features

- ♦ **Fast Settling Time: ±0.1% In 150ns**
- ♦ **High Slew Rate: 90V/μs**
- ♦ **Large Gain Bandwidth: 100MHz**
- ♦ **Full Power Bandwidth: 4.8MHz at 6V p-p**
- ♦ **Ease of Use: Internally Compensated for $A_{CL} \geq 3$ with 50°–60° Phase Margin**
- ♦ **Low Supply Voltage Operation: ±4V**
- ♦ **Wide Input Voltage Range: Within 1.5V of V_+ and 0.5V of V_-**
- ♦ **Minimal Crosstalk: >90dB Separation (MAX428/448)**
- ♦ **Short Circuit Protection**

Applications

- Video Amplifiers
- Test Equipment
- Waveform Generators
- Video Distribution
- Pulse Amplifiers

Ordering Information

PART	TEMP. RANGE	PIN-PACKAGE
MAX408ACPA	0°C to +70°C	8 Lead Plastic DIP
MAX408ACSA	0°C to +70°C	8 Lead Small Outline
MAX408CPA	0°C to +70°C	8 Lead Plastic DIP
MAX408CSA	0°C to +70°C	8 Lead Small Outline
MAX408C/D	0°C to +70°C	Dice

Ordering Information continued at end of data sheet.

Pin Configurations

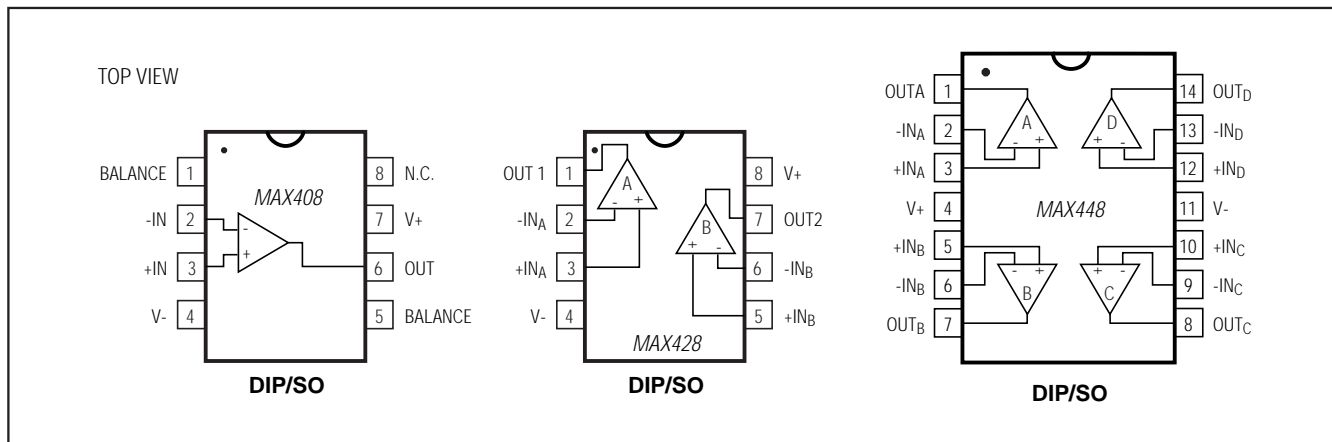

Single/Dual/Quad High-Speed, Fast-Settling, High Output Current Operational Amplifier

ABSOLUTE MAXIMUM RATINGS

Supply Voltages.....+6V	14-Pin Plastic DIP
Differential Input Voltage+9V	(derate 10.00mW/°C above +70°C).....800mW
Common Mode Input Voltage Vs -0.5V	14-Pin SO (derate 8.33mW/°C above +70°C).....667mW
Output Short Circuit Current DurationIndefinite	Operating Temperature Range
Continuous Power Dissipation (T _A = +70°C)	Commercial (MAX4_8AC/C)0°C to +70°C
8-Pin Plastic DIP (derate 9.09mW/°C above +70°C)727mW	Storage Temperature Range.....-65°C to +150°C
8-Pin SO (derate 5.88mW/°C above +70°C).....471mW	Lead Temperature (Soldering, 60 seconds).....+300° C

Stresses beyond those listed under "Absolute Maximum Ratings" may cause permanent damage to the device. These are stress ratings only, and functional operation of the device at these or any other conditions beyond those indicated in the operational sections of the specifications is not implied. Exposure to absolute maximum rating conditions for extended periods may affect device reliability.

ELECTRICAL CHARACTERISTICS—MAX408

(V_S = ±5V, T_A = +25°C, unless otherwise noted.)

PARAMETER	SYMBOL	CONDITIONS	MAX408C			MAX408AC			UNITS
			MIN	TYP	MAX	MIN	TYP	MAX	
Input Offset Voltage	V _{OS}	T _A = 25°C 0°C ≤ T _A ≤ 70°C		5 8	12 16		3 5	6 10	mV
Average Offset Voltage Drift	ΔV _{OS} /ΔT	0°C ≤ T _A ≤ 70°C		20			20		μV/°C
Input Bias Current	I _B			650	1100		650	1100	nA
Input Offset Current	I _{OS}	T _A = 25°C 0°C ≤ T _A ≤ 70°C		35 70	120 200		35 70	120 200	nA
Input Common Mode Range	V _{CM}		+3 -4	+3.5 -4.5		+3 -4	+3.5 -4.5		V
Differential Input Resistance	R _{IND}	(Note 1)	3	10		3	10		MΩ
Common Mode Input Resistance	R _{INC}	(Note 1)	4	8		4	8		MΩ
Differential Input Capacitance	C _{IND}			2			2		pF
Common Mode Input Capacitance	C _{INC}			3			3		pF
Input Voltage Noise	e _N	BW = 10Hz to 100kHz		12			12		μV _{RMS}
Open Loop Voltage Gain	A _V	V _{OUT} = ±3V, R _L = 2kΩ	2	5		5	10		V/mV
Output Voltage Swing	V _{OUT}	R _L = 2kΩ R _L = 150Ω	±3.5 ±2.0	±2.4		±3.5 ±2.5	±2.7		V
Power Supply Current	I _S			7	10		7	10	mA
Common Mode Rejection Ratio	CMRR	V _{CM} = ±2V	60	70		60	70		dB
Power Supply Rejection Ratio	PSRR	ΔV _{PS} = ±0.5V	60	66		60	66		dB
Slew Rate (Note 1)	SR	10–90% of Leading Edge (Figure 1)	60	90		60	90		V/μS
Settling Time	t _S	To ±0.1% (±4mV) of Final Value (Figure 1) (Note 1)		150	200		150	200	ns
Gain Bandwidth Product	GBW			100			100		MHz

Note 1: Not tested, guaranteed by design.

Single/Dual/Quad High-Speed, Fast-Settling, High Output Current Operational Amplifier

ELECTRICAL CHARACTERISTICS—MAX428

($V_S = \pm 5V$, $T_A = +25^\circ C$, unless otherwise noted.)

PARAMETER	SYMBOL	CONDITIONS	MAX428C			MAX428AC			UNITS
			MIN	TYP	MAX	MIN	TYP	MAX	
Input Offset Voltage	V_{OS}	$T_A = 25^\circ C$ $0^\circ C \leq T_A \leq 70^\circ C$		5 8	12 16		3 5	6 10	mV
Average Offset Voltage Drift	$\Delta V_{OS}/\Delta T$	$0^\circ C \leq T_A \leq 70^\circ C$		20			20		$\mu V/^\circ C$
Input Bias Current	I_B	$T_A = 25^\circ C$ $0^\circ C \leq T_A \leq 70^\circ C$		650	1100 1700		650	1100 1700	mA
Input Offset Current	I_{OS}			35	120		35	120	nA
Input Common Mode Range	V_{CM}		+3 -4	+3.5 -4.5		+3 -4	+3.5 -4.5		V
Differential Input Resistance	R_{IND}	(Note 1)	3	10		3	10		$M\Omega$
Common Mode Input Resistance	R_{INC}	(Note 1)	4	8		4	8		$M\Omega$
Differential Input Capacitance	C_{IND}			2			2		pF
Common Mode Input Capacitance	C_{INC}			3			3		pF
Input Voltage Noise	e_N	BW = 10Hz to 100kHz		12			12		μV_{RMS}
Open Loop Voltage Gain	A_V	$V_{OUT} = \pm 3V$, $R_L = 2k\Omega$	2	5		5	10		V/mV
Output Voltage Swing	V_{OUT}	$R_L = 2k\Omega$ $R_L = 150\Omega$	± 3.5 ± 2.0	± 2.4		± 3.5 ± 2.5	± 2.7		V
Power Supply Current (Both Amplifiers)	I_S			15	20		15	20	mA
Common Mode Rejection Ratio	CMRR	$V_{CM} = \pm 2V$	60	70		60	70		dB
Power Supply Rejection Ratio	PSRR	$\Delta V_{PS} = \pm 0.5V$	60	66		60	66		dB
Slew Rate (Note 1)	SR	10–90% of Leading Edge (Figure 1)	60	90		60	90		V/ μS
Settling Time	t_S	To $\pm 0.1\%$ ($\pm 4mV$) of Final Value (Figure 1) (Note 1)		150	200		150	200	ns
Gain Bandwidth Product	GBW			100			100		MHz

Note 1: Not tested, guaranteed by design.

MAX408/428/448

Single/Dual/Quad High-Speed, Fast-Settling, High Output Current Operational Amplifier

ELECTRICAL CHARACTERISTICS—MAX448

($V_S = \pm 5V$, $T_A = +25^\circ C$, unless otherwise noted.)

PARAMETER	SYMBOL	CONDITIONS	MAX408C			MAX408AC			UNITS
			MIN	TYP	MAX	MIN	TYP	MAX	
Input Offset Voltage	V_{OS}	$T_A = 25^\circ C$ $0^\circ C \leq T_A \leq 70^\circ C$		5 8	12 16		3 5	6 10	mV
Average Offset Voltage Drift	$\Delta V_{OS}/\Delta T$	$0^\circ C < T_A \leq 70^\circ C$		20			20		$\mu V/^\circ C$
Input Bias Current	I_B	$T_A = 25^\circ C$ $0^\circ C \leq T_A \leq 70^\circ C$		650	1100 1700		650	1100 1700	nA
Input Offset Current	I_{OS}			35	120		35	120	nA
Input Common Mode Range	V_{CM}		+3 -4	+3.5 -4.5		+3 -4	+3.5 -4.5		V
Differential Input Resistance	R_{IND}	(Note 1)	3	10		3	10		$M\Omega$
Common Mode Input Resistance	R_{INC}	(Note 1)	4	8		4	8		$M\Omega$
Differential Input Capacitance	C_{IND}			2					pF
Common Mode Input Capacitance	C_{INC}			3			3		pF
Input Voltage Noise	e_N	BW = 10Hz to 100kHz		12			12		μV_{RMS}
Open Loop Voltage Gain	A_V	$V_{OUT} = \pm 3V$, $R_L = 2k\Omega$	2	5		4	10		V/mV
Output Voltage Swing	V_{OUT}	$R_L = 2k\Omega$ $R_L = 150\Omega$	± 3.5 ± 2.0	± 2.4		± 3.5 ± 2.5	± 2.7		V
Power Supply Current (All Four Amplifiers)	I_S			30	40		30	40	mA
Power Supply Rejection Ratio	PSRR	$\Delta V_{PS} = \pm 0.5V$	60	66		60	66		dB
Common Mode Rejection Ratio	CMRR	$V_{CM} = \pm 2V$	60	70		60	70		dB
Slew Rate (Note 1)	SR	10–90% of Leading Edge (Figure 1)	60	90		60	90		V/ μS
Settling Time	t_S	To $\pm 0.1\%$ ($\pm 4mV$) of Final Value (Figure 1) (Note 1)		150	200		150	200	ns
Gain Bandwidth Product	GBW			100			100		MHz

Note 1: Not tested, guaranteed by design.

AC CHARACTERISTICS—MAX408/428/448

($V_S = \pm 5V$, $T_A = +25^\circ C$, unless otherwise specified.)

PARAMETER	SYMBOL	CONDITIONS	MAX4XXC			MAX4XXC			UNITS
			MIN	TYP	MAX	MIN	TYP	MAX	
Small Signal Rise/Fall Time	tr/TF	$e_O = \pm 100mV$ 10–90% (Figure 1)		7			7		ns
Full Power Bandwidth	BW _{FP}	$R_L = 2k\Omega$, $C_L = 50pF$ $V_{OUT} = 6Vp-p$		4.8			4.8		MHz
Amp-Amp Crosstalk (MAX428/448)		Input Referenced $f = 10kHz$		-96			-96		dB

Single/Dual/Quad High-Speed, Fast-Settling, High Output Current Operational Amplifier

Typical Operating Characteristics

($V_S = \pm 5$, $T_A = +25^\circ\text{C}$, unless otherwise stated and apply for each individual op amp where applicable.)

MAX408/428/448

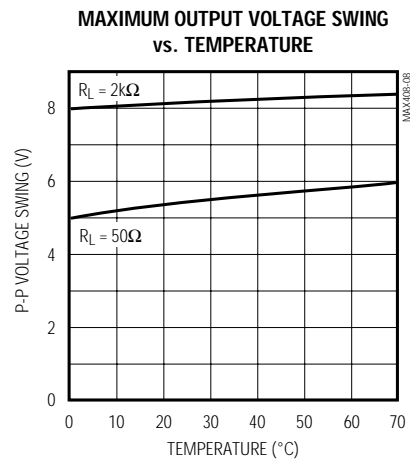
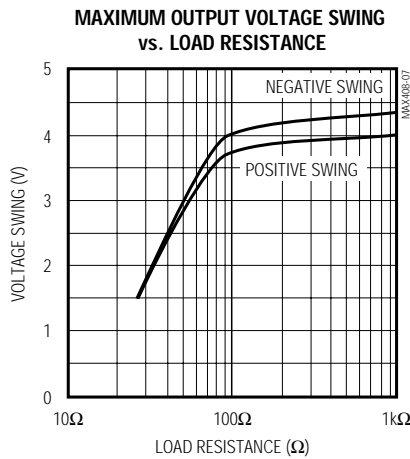
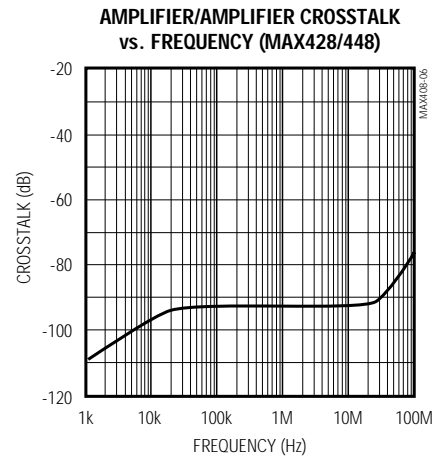
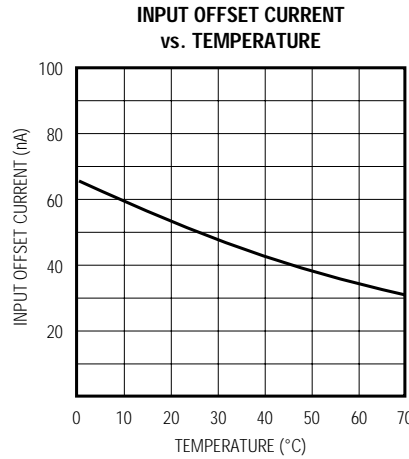
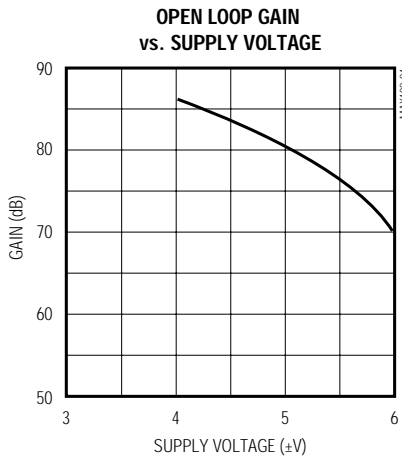
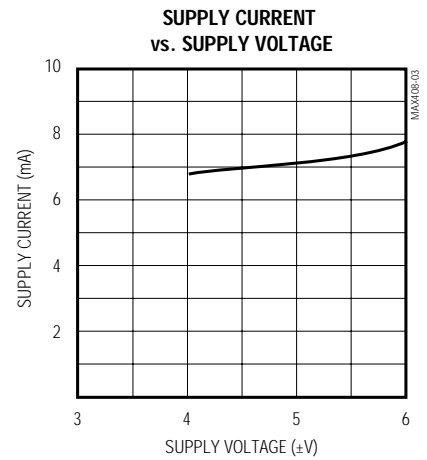
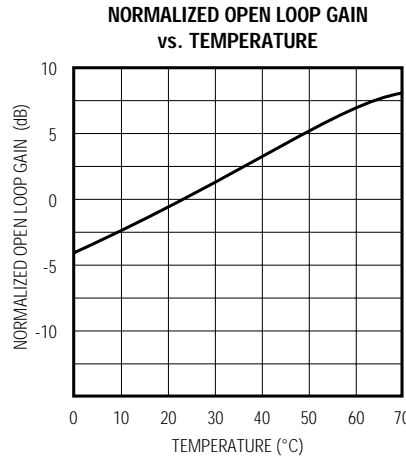
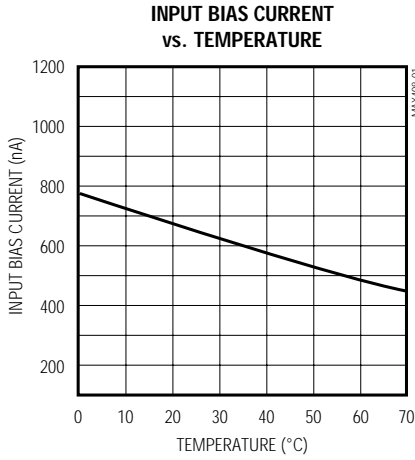

Single/Dual/Quad High-Speed, Fast-Settling, High Output Current Operational Amplifier

Typical Operating Characteristics

($T_A = +25^\circ\text{C}$, unless otherwise noted.)

SHORT CIRCUIT OUTPUT CURRENT vs. TEMPERATURE

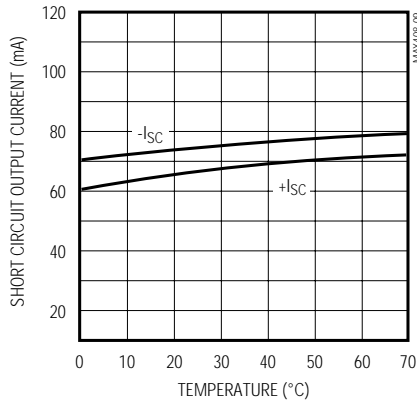

EQUIVALENT INPUT NOISE vs. BANDWIDTH

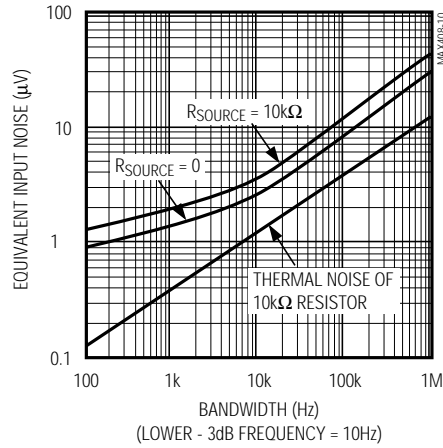

OPEN LOOP FREQUENCY RESPONSE

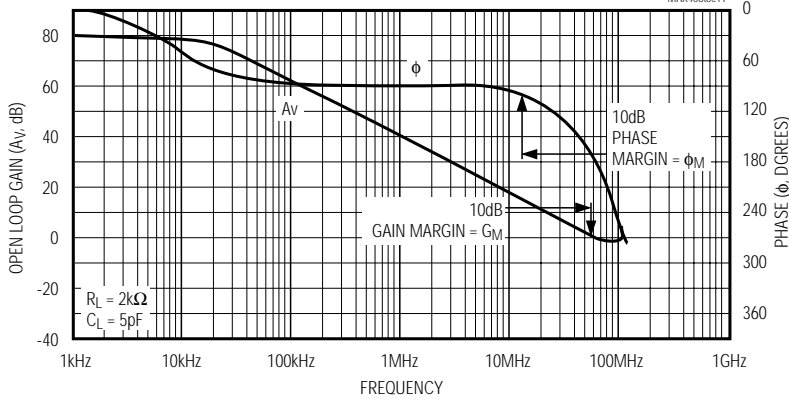

OPEN LOOP FREQUENCY RESPONSE, R_L = 50Ω, C_L = 50pF

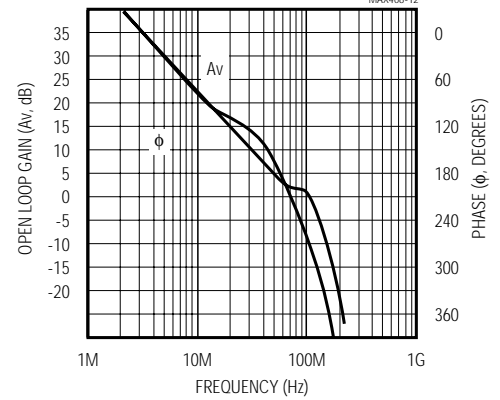

OPEN LOOP FREQUENCY RESPONSE, R_L = 2kΩ, C_L = 50pF

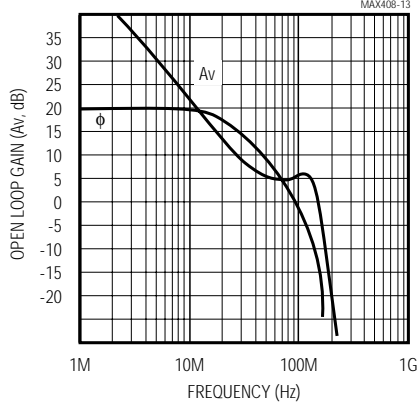

10dB PHASE MARGIN AND 10dB FREQUENCY vs. TEMP

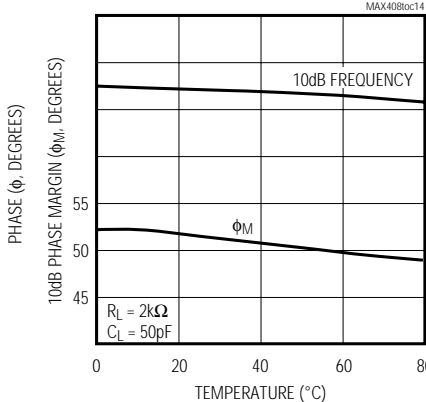

GAIN MARGIN AND 180 DEGREE FREQUENCY vs. TEMP (A_V = 10dB)

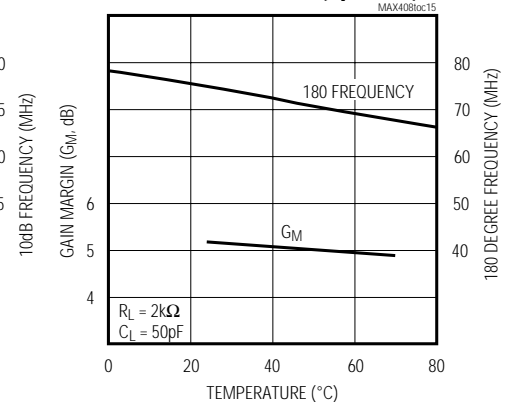

Single/Dual/Quad High-Speed, Fast-Settling, High Output Current Operational Amplifier

MAX408/428/448

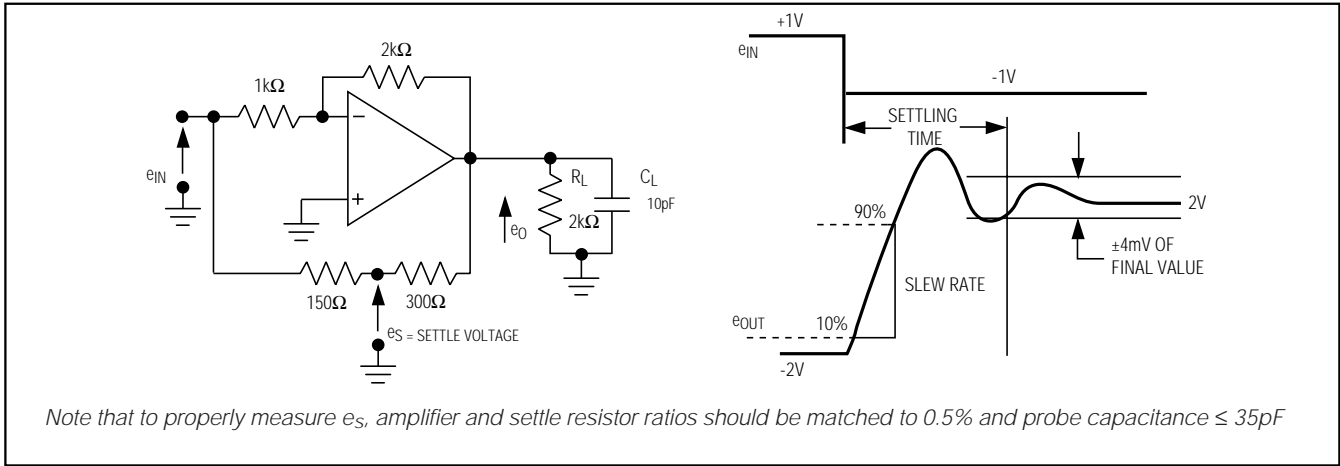

Figure 1A. Settling Time and Slew Rate Test Circuit

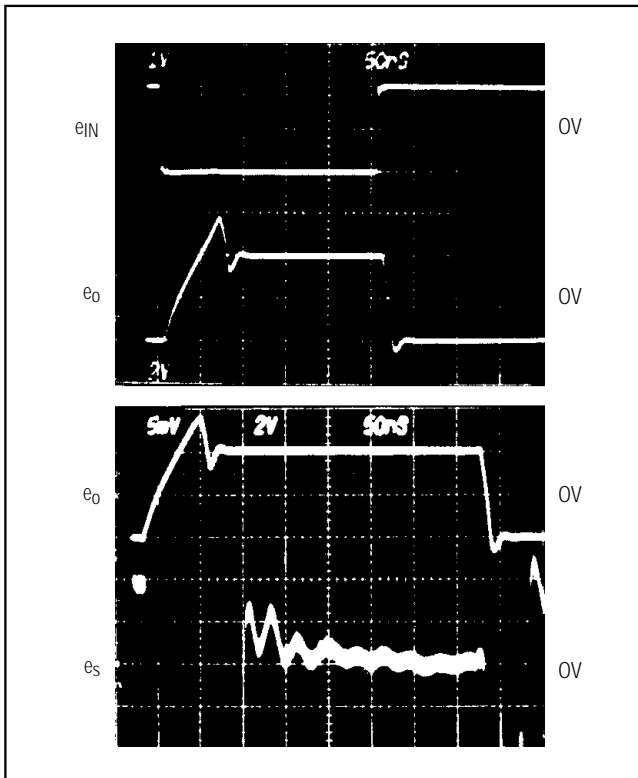

Figure 1B. Large Signal Response

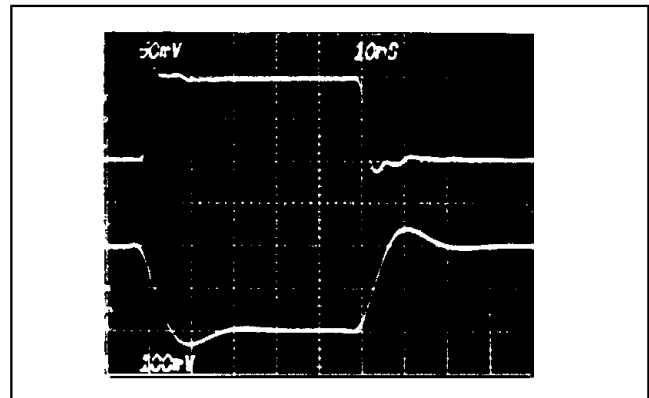

Figure 1C. Small Signal Response

Application Information

AC Characteristics

The 35MHz 10dB crossover point of the MAX408/428/448 is achieved without feed forward compensation, a technique which can produce long tails in the recovery characteristic. The single pole rolloff follows the classic 20dB/decade slope to frequencies approaching 50MHz. The 10dB (3.2V/V) phase margin of 50°, even with a capacitive load of 50pF, gives stable and predictable performance down to non-inverting gain configurations of approximately 3V/V (inverting gains of -2V/V). At frequencies beyond 50MHz, the 20dB/decade slope is disturbed by an output stage zero, the damping factor of which is dependent upon the R_L , C_L load combination. This results in loss of gain

Single/Dual/Quad High-Speed, Fast-Settling, High Output Current Operational Amplifier

margin (gain at loop phase = 360°) at frequencies of 70 to 100MHz which at a gain margin of 5dB ($R_L = 2k$, $C_L = 5pF$) results in a peak in the gain of 3 amplifier configurations as shown in Figures 3 and 4.

Figure 3 shows a blow up of the open loop characteristics in the 10MHz to 200MHz frequency range, as well as the corresponding closed loop characteristics for a gain of three non-inverting amplifier at similar load conditions. It should be noted that the open loop characteristic does not show the additional phase shift covered by the input capacitance pole. This is why the closed loop peaking at 30 to 40MHz is greater than what would be expected from the 50 to 60 degrees of phase margin indicated by the open loop characteristics. Corresponding small signal step response characteristics show well-behaved pulse waveforms with 16–33% overshoot.

The input capacitive pole can be neutralized by adding a feedback capacitor to R_2 . The value of capacitance is selected according to $R_1 C_{IN} = R_2 C_{FB}$, where C_{IN} is the sum of the common mode and differential input capacitance $\approx 5pF$. For $R_2 = 2R_1$, $C_{FB} = C_{IN}/2 \approx 2.5pF$.

Figure 4 shows the results of this feedback capacitor addition. Neutralizing the input capacitance demonstrates the peaking that can result from the loss of gain margin at 70 to 100MHz. As the load time constant

($R_L C_L$) increases the peaking gets progressively worse $\approx 6dB$ at $R_L = 2K$, $C_L = 50pF$. The step response waveforms are as expected with a very strong 88MHz ring being exhibited at $R_L = 2k$, $C_L = 50pF$ and no overshoot at $R_L = 50\Omega$, $C_L = 5pF$.

Layout Considerations

As with any high-speed wideband amplifier, certain layout considerations are necessary to ensure stable operation. All connections to the amplifier should remain as short as possible, and the power supplies bypassed with 0.1 μF capacitors to signal ground. It is suggested that a ground plane be considered as the best method for ensuring stability because it minimizes stray inductance and unwanted coupling in the ground signal paths.

To minimize capacitive effects, resistor values should be kept as small as possible, consistent with the application.

MAX408 Offset Voltage Nulling

The configuration of Figure 2 will give a typical V_{OS} nulling range of $\pm 15mV$. If a smaller adjustment range is desired, resistor values R_1 and R_2 can be increased accordingly. For example, at $R_1 = 3.6k\Omega$, the adjustment range is $\pm 5mV$. Since pins 1 and 5 are not part of the signal path, AC characteristics are left undisturbed.

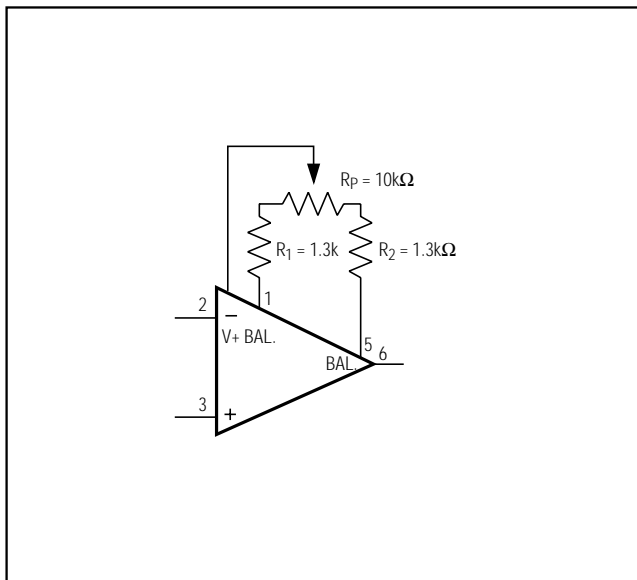
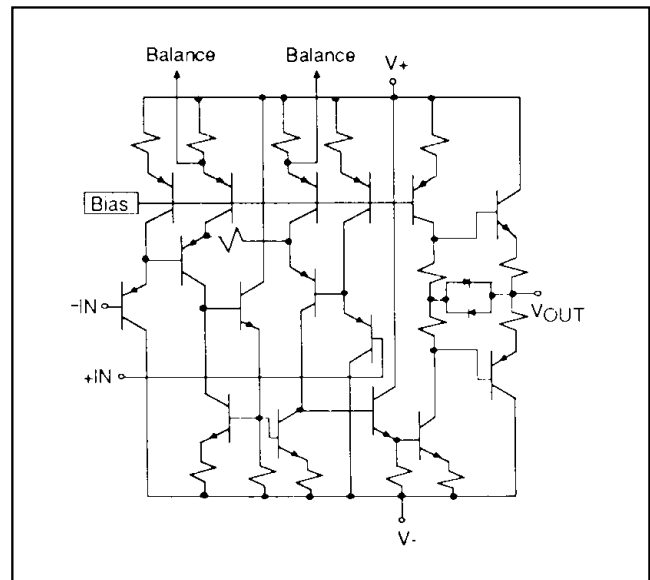

Figure 2. V_{OS} Nulling Method for MAX408



Simplified Schematic. For MAX428/448 omit balance pins.

Single/Dual/Quad High-Speed, Fast-Settling, High Output Current Operational Amplifier

MAX408/428/448

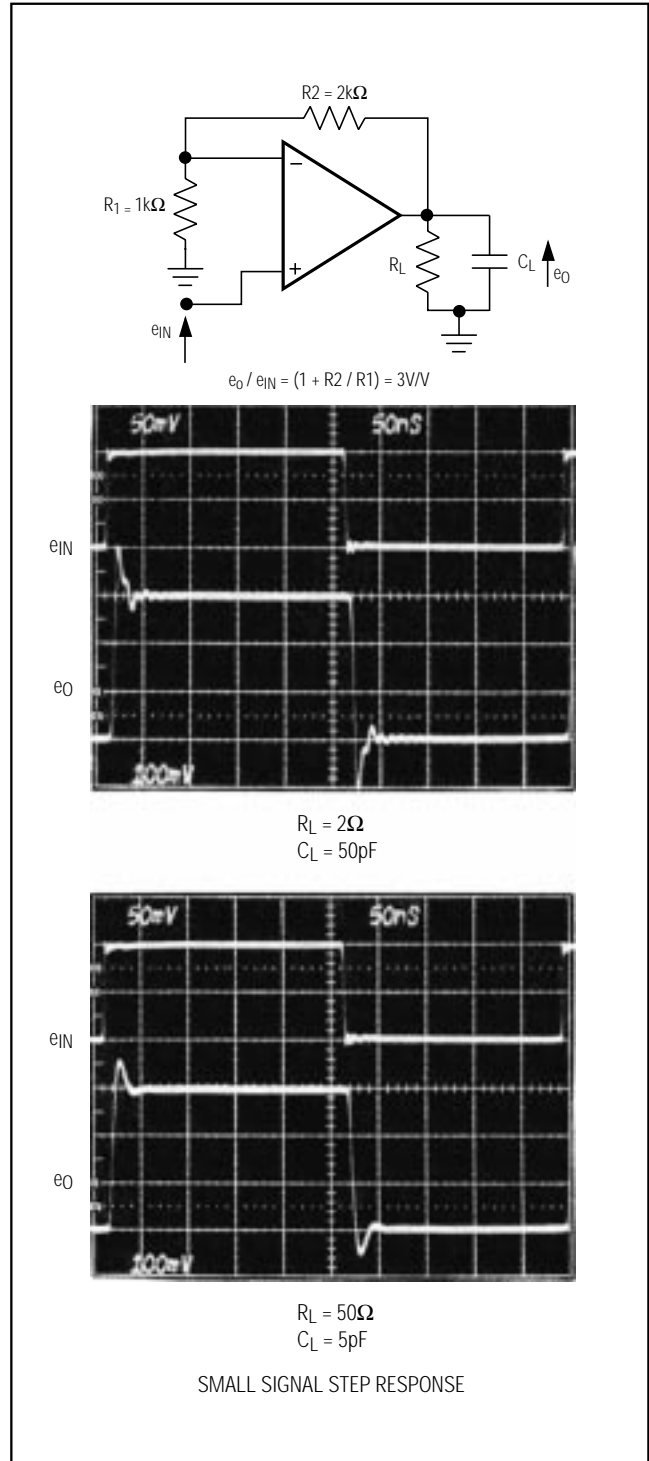
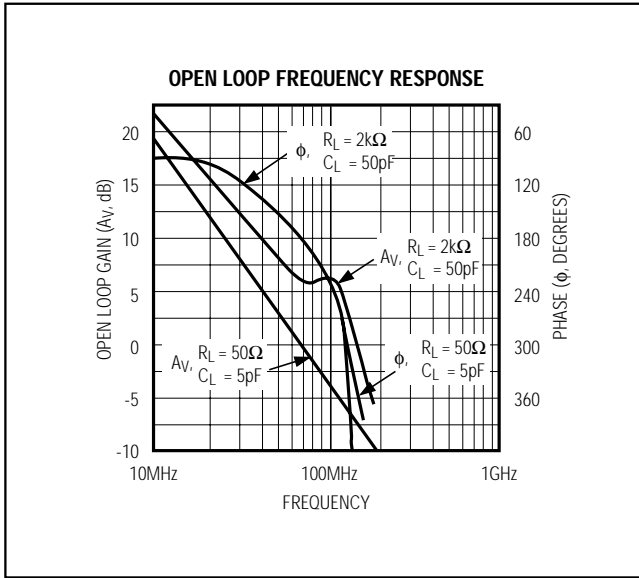

Figure 3. Frequency and Time Domain Response Characteristics, $A_v = 3$

Single/Dual/Quad High-Speed, Fast-Settling, High Output Current Operational Amplifier

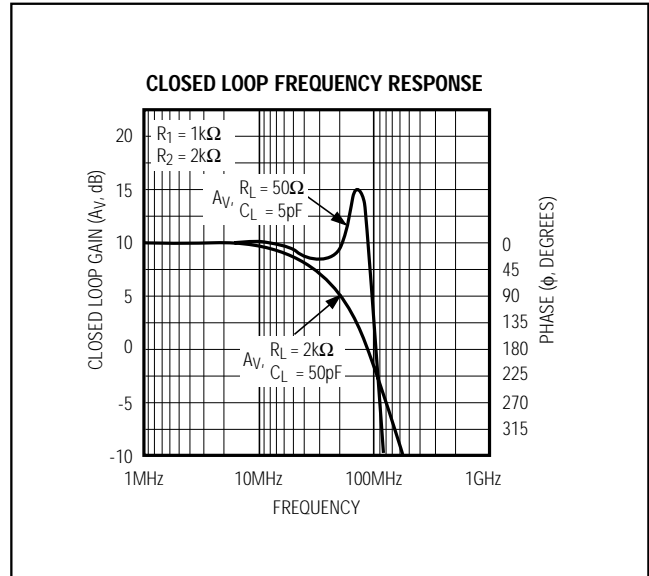
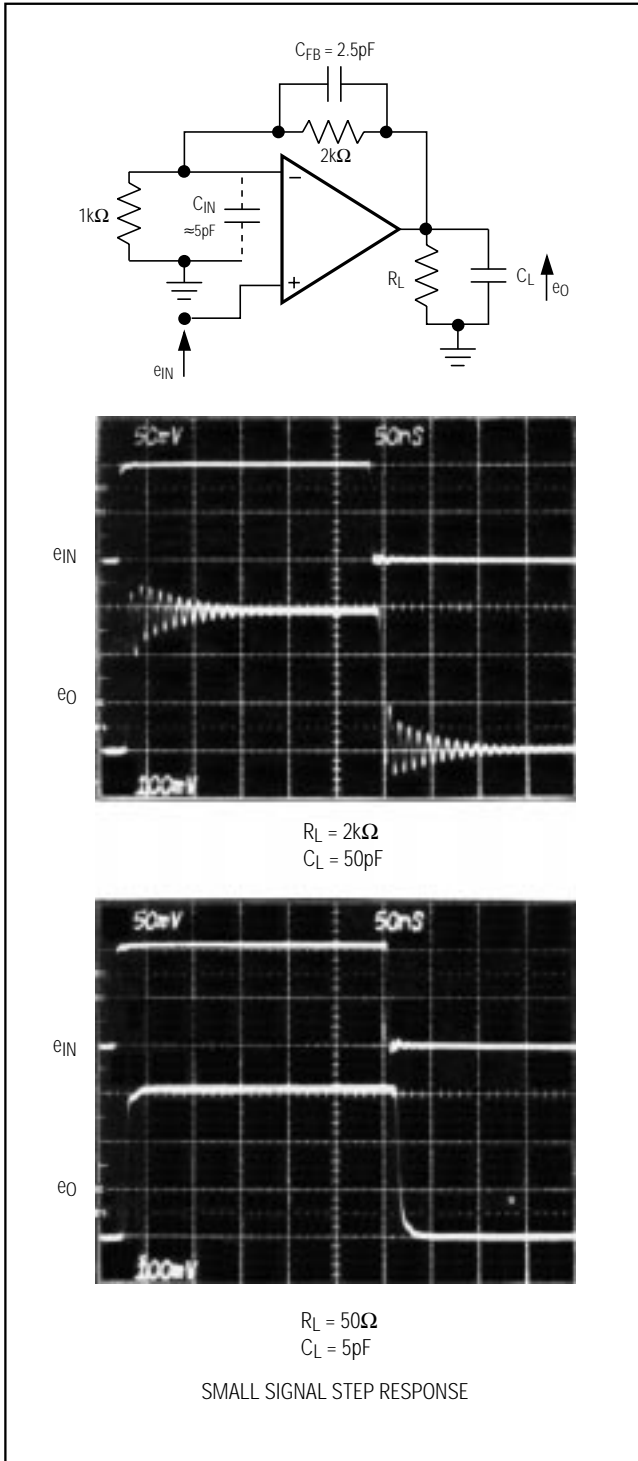

Figure 4. Response Characteristics with Input Pole Cancellation, $A_v = 3$

Single/Dual/Quad High-Speed, Fast-Settling, High Output Current Operational Amplifier

__Ordering Information (continued)

PART	TEMP. RANGE	PIN-PACKAGE
MAX428A_CPA	0°C to +70°C	8 Lead Plastic DIP
MAX428ACSA	0°C to +70°C	8 Lead Small Outline
MAX428CPA	0°C to +70°C	8 Lead Plastic DIP
MAX428CSA	0°C to +70°C	8 Lead Small Outline
MAX428C/D	0°C to +70°C	Dice
MAX448ACPD	0°C to +70°C	14 Lead Plastic DIP
MAX448ACSD	0°C to +70°C	14 Lead Small Outline
MAX448CPD	0°C to +70°C	14 Lead Plastic DIP
MAX448CSD	0°C to +70°C	14 Lead Small Outline
MAX448C/D	0°C to +70°C	Dice

MAX408/428/448