

EVALUATION KIT
AVAILABLE

MAXIM

500kHz, 36V Output, SOT23, PWM Step-Up DC-DC Converters

General Description

The MAX5025–MAX5028 constant-frequency, pulse-width modulating (PWM), low-noise boost converters are intended for low-voltage systems that often need a locally generated high voltage. These devices are capable of generating low-noise, high output voltages required for varactor diode biasing in TV tuners, set-top boxes, and PCI cable modems. The MAX5025–MAX5028 operate from as low as 3V and switch at 500kHz.

The constant-frequency, current-mode PWM architecture provides for low output noise that is easy to filter. A 40V lateral DMOS device is used as the internal power switch, making the devices ideal for boost converters up to 36V. The MAX5025/MAX5026 adjustable versions require the use of external feedback resistors to set the output voltage. The MAX5027/MAX5028 offer a fixed 30V output. These devices are available in a small, 6-pin SOT23 package.

Applications

TV Tuner Power Supply
Low-Noise Varactor Diode Biasing
Set-Top Box Tuner Power Supply
PCI Cable Modem
Voice-Over-Cable
LCD Power Supply
Avalanche Photodiode Biasing

Typical Operating Circuit

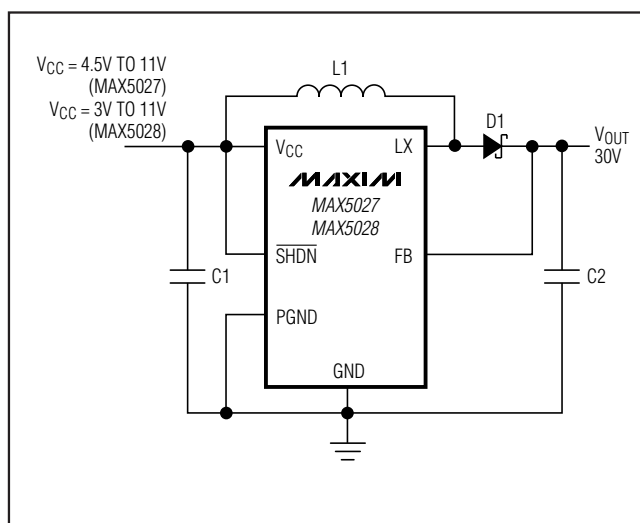

Features

- ◆ Input Voltage Range:
3V to 11V (MAX5026/MAX5028)
4.5V to 11V (MAX5025/MAX5027)
- ◆ Wide Output Voltage Range: V_{CC} to 36V
- ◆ Output Power: 120mW (max)
- ◆ User-Adjustable Output Voltage with MAX5025/MAX5026 Using External Feedback Resistors
- ◆ Fixed 30V Output Voltage: MAX5027/MAX5028
- ◆ Internal 1.3 Ω (typ), 40V Switch
- ◆ Constant PWM Frequency Provides Easy Filtering in Low-Noise Applications
- ◆ 500kHz (typ) Switching Frequency
- ◆ 1 μ A (max) Shutdown Current
- ◆ Small, 6-Pin SOT23 Package

Ordering Information

PART	TEMP RANGE	PIN-PACKAGE
MAX5025EUT-T	-40°C to +85°C	6 SOT23-6
MAX5026EUT-T	-40°C to +85°C	6 SOT23-6
MAX5027EUT-T	-40°C to +85°C	6 SOT23-6
MAX5028EUT-T	-40°C to +85°C	6 SOT23-6

Selector Guide appears at end of data sheet.

Pin Configuration

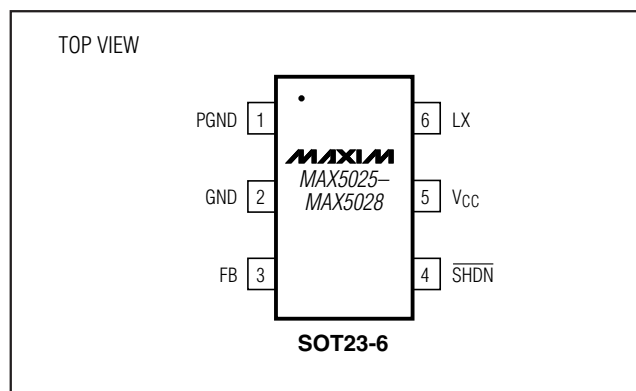

MAXIM

Maxim Integrated Products 1

For pricing, delivery, and ordering information, please contact Maxim Direct at 1-888-629-4642, or visit Maxim's website at www.maxim-ic.com.

MAX5025-MAX5028

500kHz, 36V Output, SOT23, Step-Up DC-DC Converters

ABSOLUTE MAXIMUM RATINGS

V _{CC} to GND	-0.3V to +12V
PGND to GND	-0.1V to +0.1V
FB to GND (MAX5025/MAX5026)	-0.3V to (V _{CC} + 0.3V)
FB to GND (MAX5027/MAX5028)	-0.3V to +40V
SHDN to GND	-0.3V to (V _{CC} + 0.3V)
LX to GND	-0.3V to +45V
Peak LX Current	600mA

Operating Temperature Range	-40°C to +85°C
Continuous Power Dissipation (T _A = +70°C)	
6-Pin SOT23 (derate 8.7mW/°C above +70°C)	695.7mW
Junction Temperature	+150°C
Storage Temperature Range	-65°C to +165°C
Lead Temperature (soldering 10s)	+300°C

Stresses beyond those listed under "Absolute Maximum Ratings" may cause permanent damage to the device. These are stress ratings only, and functional operation of the device at these or any other conditions beyond those indicated in the operational sections of the specifications is not implied. Exposure to absolute maximum rating conditions for extended periods may affect device reliability.

ELECTRICAL CHARACTERISTICS

(V_{CC} = 5V, $\overline{\text{SHDN}}$ = V_{CC}, T_A = -40°C to +85°C, unless otherwise noted. Typical values are at T_A = +25°C.) (Note 1)

PARAMETER	SYMBOL	CONDITIONS	MIN	TYP	MAX	UNITS
SUPPLY VOLTAGE						
Input Voltage Range	V _{CC}	MAX5026/MAX5028	3.0		11	V
		MAX5025/MAX5027	4.5		11	
Undervoltage Lockout	V _{UVLO}	Rise/fall, hysteresis = 3mV	2.25	2.65	2.95	V
Supply Current	I _{CC}	MAX5025/MAX5026, FB = 1.4V MAX5027/MAX5028, FB = 35V		350	1000	μA
Shutdown Current	I _{SHDN}	SHDN = GND		0.01	1	μA
BOOST CONVERTER						
Switching Frequency	f _{SW}	MAX5025/MAX5027	345	500	1000	kHz
		MAX5026/MAX5028, V _{CC} = 3.3V	410	500	670	
Line Regulation		MAX5025/MAX5027, I _{LOAD} = 2mA, V _{CC} = 4.5V to 11V, V _{OUT} = 30V		0.25		%V
		MAX5026/MAX5028, I _{LOAD} = 0.5mA, V _{CC} = 3V to 11V, V _{OUT} = 30V		0.25		
Load Regulation		MAX5025/MAX5027, V _{CC} = 5V, I _{LOAD} = 0 to 4mA, V _{OUT} = 30V		2.0		%
		MAX5026/MAX5028, V _{CC} = 3.3V, I _{LOAD} = 0 to 1mA, V _{OUT} = 30V		1.0		
Thermal Shutdown				140		°C
Thermal Shutdown Hysteresis				2		°C

500kHz, 36V Output, SOT23, Step-Up DC-DC Converters

MAX5025-MAX5028

ELECTRICAL CHARACTERISTICS (continued)

($V_{CC} = 5V$, $\overline{SHDN} = V_{CC}$, $T_A = -40^\circ\text{C}$ to $+85^\circ\text{C}$, unless otherwise noted. Typical values are at $T_A = +25^\circ\text{C}$.) (Note 1)

PARAMETER	SYMBOL	CONDITIONS			MIN	TYP	MAX	UNITS
FB Set Point	V_{FB}	MAX5025, $V_{CC} = 4.5V$ to $11V$			1.19	1.25	1.31	V
		MAX5027, $V_{CC} = 4.5V$ to $11V$			28.5	30.0	31.5	
		MAX5026, $V_{CC} = 3.3V$ to $11V$			1.212	1.25	1.288	
		MAX5028, $V_{CC} = 3.3V$ to $11V$			29.0	30	31	
FB Input Bias Current	I_{FB}	MAX5025/MAX5026, $FB = 1V$				110	310	nA
		MAX5027/MAX5028, $FB = 30V$				100	170	μA
Output Voltage Adjustment Range		MAX5025/MAX5026			$V_{CC} + 1$		36	V
LX OUTPUT								
LX On-Resistance	R_{ON}	$I_{LX} = 40\text{mA}$	MAX5026/MAX5028, $V_{CC} = 3V$			2.0	4.0	Ω
			$V_{CC} = 5V$			1.3	3.0	
			$V_{CC} = 11V$			1.0	2.5	
Switch Current Limit	I_{LIM}	Note 2				260		mA
LX Leakage Current		$V_{LX} = 40V$	MAX5025/MAX5026, $V_{FB} = 1.4V$			0.01	10	μA
			MAX5027/MAX5028, $V_{FB} = 35V$					
LOGIC INPUT: \overline{SHDN}								
Input Low Level	V_{IL}						0.8	V
Input High Level	V_{IH}				2.4			V
Input Bias Current					-1		1	μA

Note 1: All devices are 100% production tested at $T_A = +25^\circ\text{C}$. All temperature limits are guaranteed by design.

Note 2: Switch current-limit accuracy is typically $\pm 20\%$ and is a function of the input voltage. $I_{LIM} = (V_{IN}/5)$ (260mA).

500kHz, 36V Output, SOT23, Step-Up DC-DC Converters

Typical Operating Characteristics

($V_{CC} = 5V$, $V_{OUT} = 30V$, $T_A = +25^\circ C$, unless otherwise noted.)

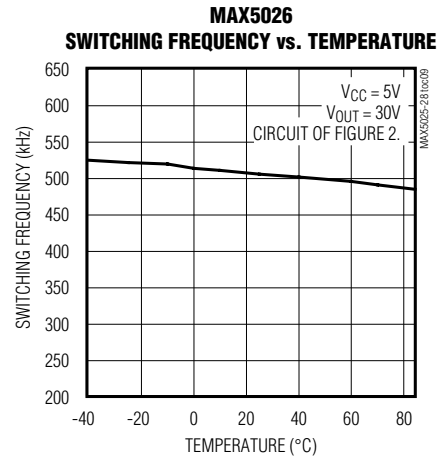
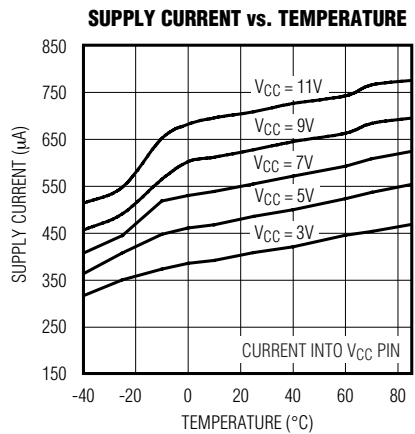
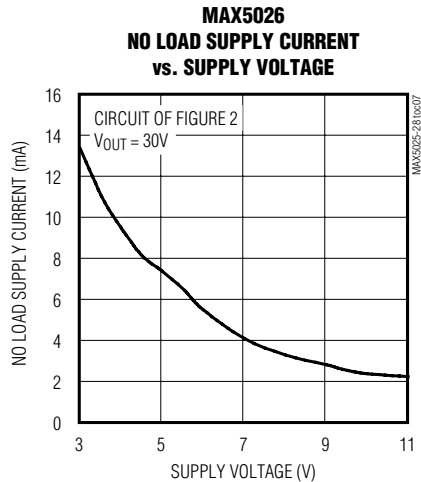
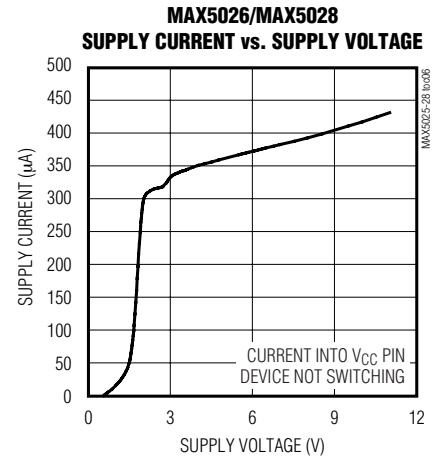
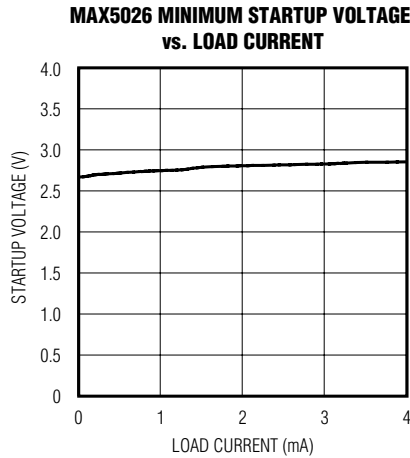
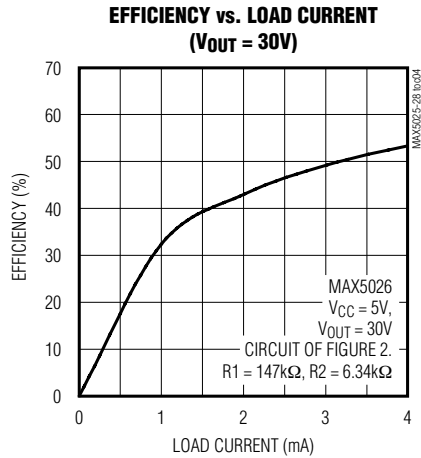
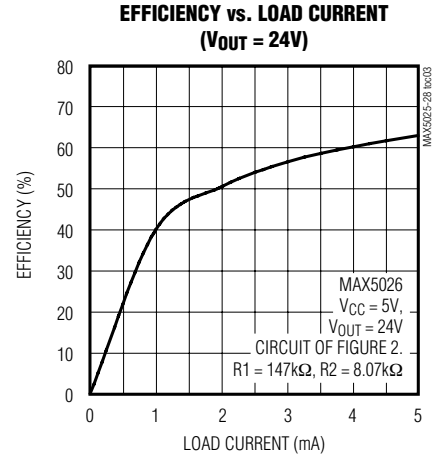
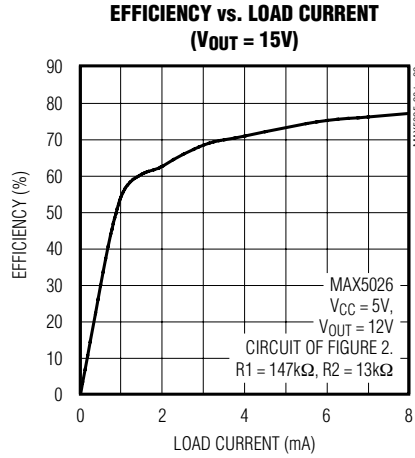
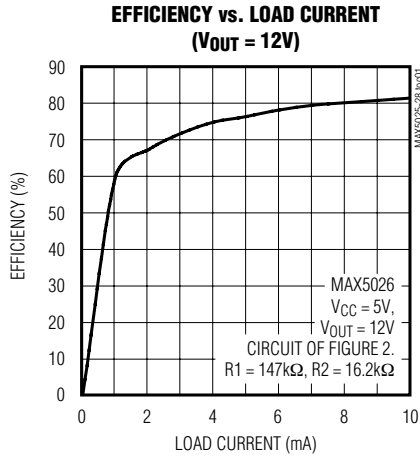

500kHz, 36V Output, SOT23, Step-Up DC-DC Converters

MAX5025-MAX5028

Typical Operating Characteristics (continued)

($V_{CC} = 5V$, $V_{OUT} = 30V$, $T_A = +25^\circ C$, unless otherwise noted.)

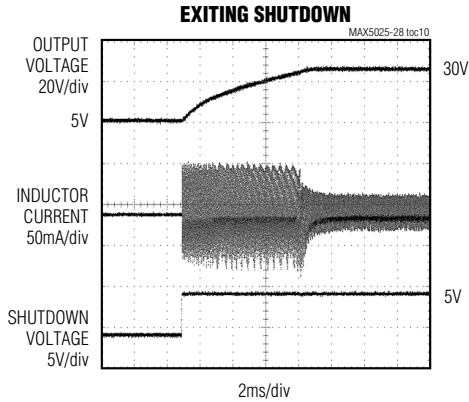

MAX5026, $V_{CC} = 5V$, $V_{OUT} = 30V$, $I_{LOAD} = 1mA$.
CIRCUIT OF FIGURE 3

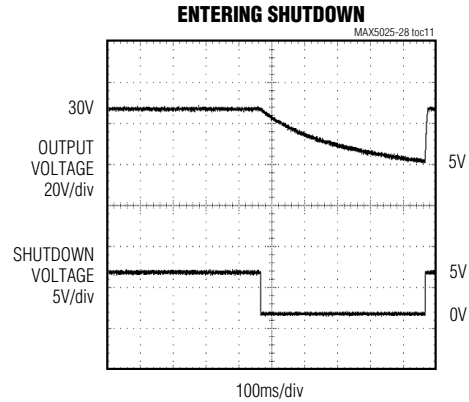

MAX5026, $V_{CC} = 5V$, $V_{OUT} = 30V$, $I_{LOAD} = 1mA$.
CIRCUIT OF FIGURE 3

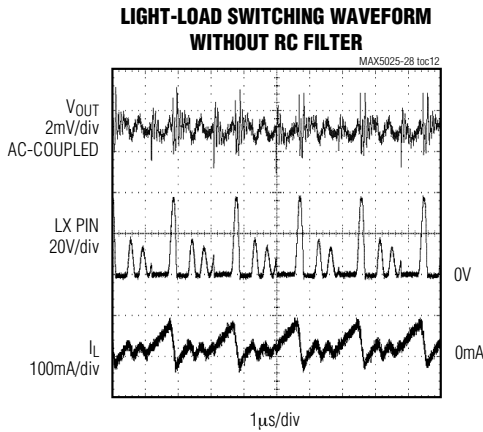

MAX5026, $V_{CC} = 5V$, $V_{OUT} = 30V$, $I_{LOAD} = 0.1mA$.
CIRCUIT OF FIGURE 2

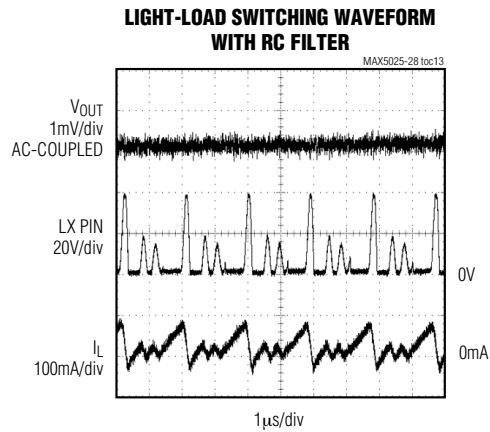

MAX5026, $V_{CC} = 5V$, $V_{OUT} = 30V$, $I_{LOAD} = 0.1mA$.
CIRCUIT OF FIGURE 3

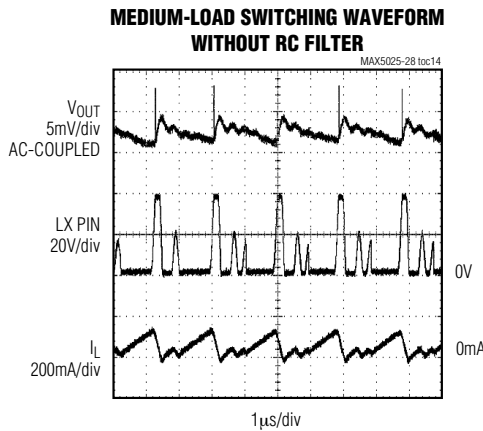

MAX5026, $V_{CC} = 5V$, $V_{OUT} = 30V$, $I_{LOAD} = 2mA$.
CIRCUIT OF FIGURE 2

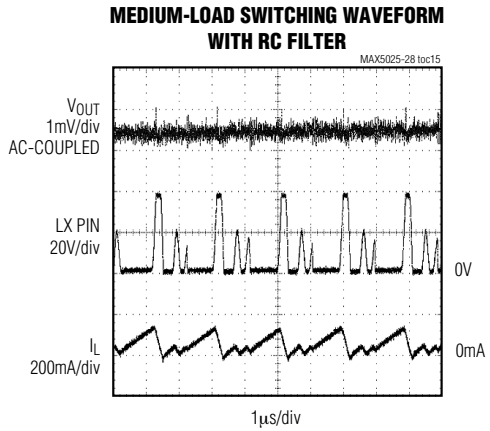

MAX5026, $V_{CC} = 5V$, $V_{OUT} = 30V$, $I_{LOAD} = 2mA$.
CIRCUIT OF FIGURE 3

500kHz, 36V Output, SOT23, Step-Up DC-DC Converters

Typical Operating Characteristics (continued)

($V_{CC} = 5V$, $V_{OUT} = 30V$, $T_A = +25^\circ C$, unless otherwise noted.)

HEAVY-LOAD SWITCHING WAVEFORM WITHOUT RC FILTER

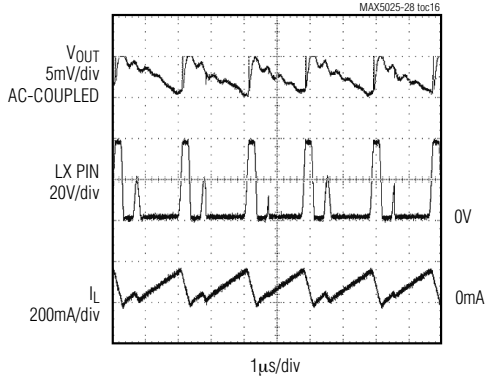

MAX5026, $V_{CC} = 5V$, $V_{OUT} = 30V$, $I_{LOAD} = 4mA$.
CIRCUIT OF FIGURE 2

HEAVY-LOAD SWITCHING WAVEFORM WITH RC FILTER

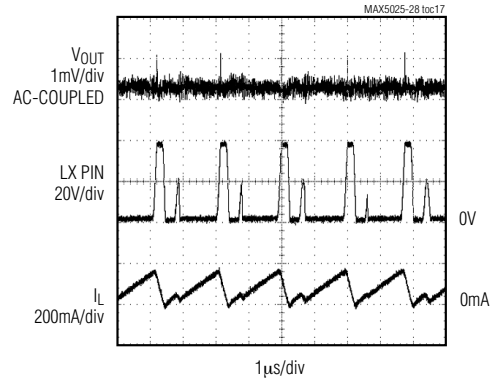

MAX5026, $V_{CC} = 5V$, $V_{OUT} = 30V$, $I_{LOAD} = 4mA$.
CIRCUIT OF FIGURE 3

LOAD TRANSIENT RESPONSE

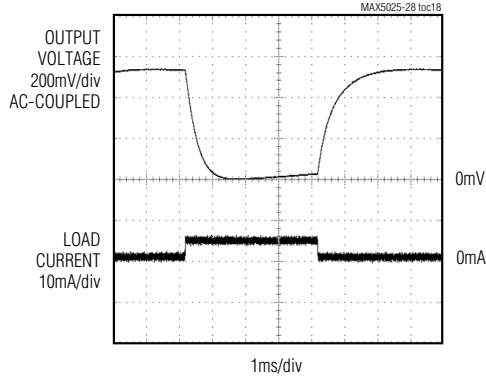

MAX5026, $V_{CC} = 5V$, $V_{OUT} = 30V$, $I_{LOAD} = 0$ TO 4mA.
CIRCUIT OF FIGURE 2

LINE TRANSIENT RESPONSE

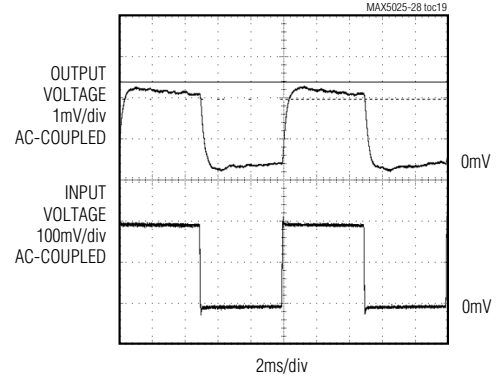

MAX5026, $V_{CC} = 5V$ TO 5.2V, $V_{OUT} = 30V$, $I_{LOAD} = 1mA$.
CIRCUIT OF FIGURE 2

**MAX5026
FB PIN VOLTAGE vs. TEMPERATURE**

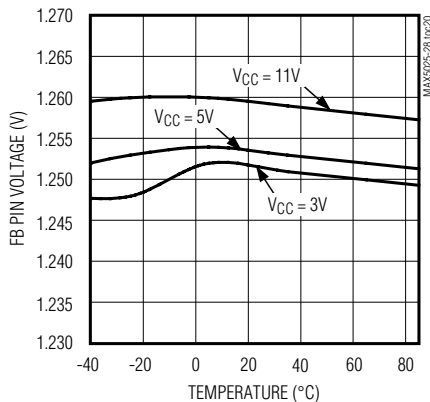

**MAX5028
FB PIN VOLTAGE vs. TEMPERATURE**

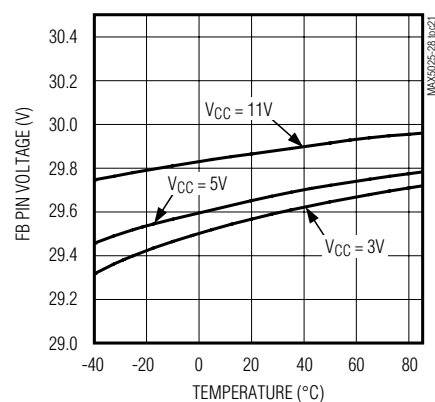

500kHz, 36V Output, SOT23, Step-Up DC-DC Converters

MAX5025-MAX5028

Typical Operating Characteristics (continued)

($V_{CC} = 5V$, $V_{OUT} = 30V$, $T_A = +25^\circ C$, unless otherwise noted.)

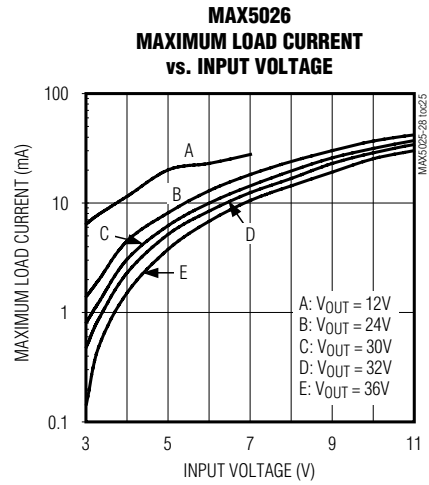
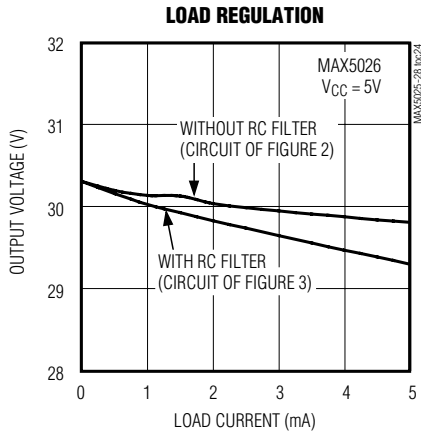
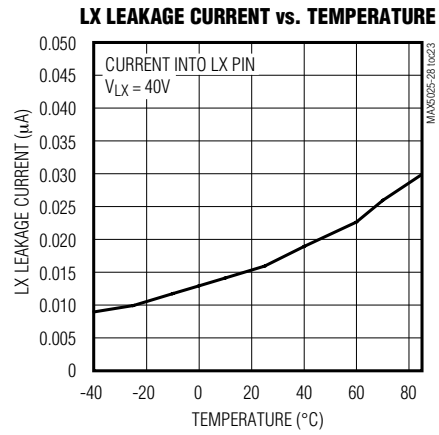
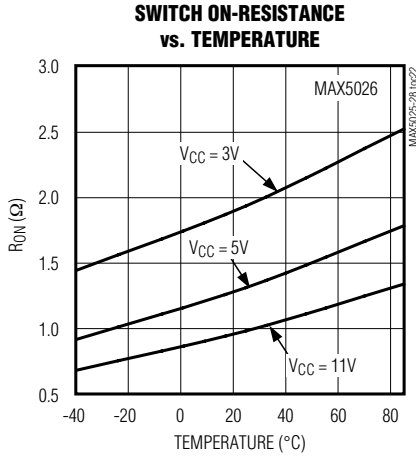

500kHz, 36V Output, SOT23, Step-Up DC-DC Converters

Pin Description

PIN		NAME	FUNCTION
MAX5025/ MAX5026	MAX5027/ MAX5028		
1	1	PGND	Power Ground. Connect directly to local ground plane. Use a star ground configuration for low noise.
2	2	GND	Ground. Connect directly to local ground plane.
3	—	FB	Feedback Pin. Reference voltage is approximately 1.25V. Connect resistive-divider tap here. Minimize trace area at FB. See <i>Setting the Output Voltage</i> section.
—	3	FB	Feedback Pin. Connect V_{OUT} to FB for +30V. Internal resistors divide down the output voltage.
4	4	$\overline{\text{SHDN}}$	Shutdown Pin. Connect to V_{CC} to enable device. Connect to GND to shut down.
5	5	V_{CC}	Input Supply Voltage. Bypass with a 4.7 μF ceramic capacitor.
6	6	LX	Drain of Internal 40V N-Channel DMOS. Connect inductor/diode to LX. Minimize trace area at this pin to keep EMI down.

Detailed Description

The MAX5025–MAX5028 current-mode PWM controllers operate in a wide range of DC-DC conversion applications including boost, flyback, and isolated output configurations. These converters provide low-noise, high output voltages making them ideal for varactor diode tuning applications as well as TFT LCD bias. Other features include shutdown, fixed 500kHz PWM oscillator, and a wide input range: 3V to 11V for MAX5026/MAX5028 and 4.5V to 11V for MAX5025/MAX5027.

The MAX5025–MAX5028 operate in discontinuous mode in order to reduce the switching noise at the output. Other continuous mode boost converters generate a large voltage spike at the output when the LX switch turns on because there is a conduction path between the output, diode, and switch to ground during the time needed for the diode to turn off.

To reduce the output noise even further, the LX switch turns off by taking 40ns typically to transition from “ON” to “OFF.” As a consequence, the positive slew rate of the LX node is reduced and the current from the inductor does not “force” the output voltage as hard as would be the case if the LX switch were to turn off more quickly.

PWM Controller

The heart of the MAX5025–MAX5028 current-mode PWM controllers is a BiCMOS multi-input comparator that simultaneously processes the output-error signal and switch current signal. The main PWM comparator

is direct summing, lacking a traditional error amplifier and its associated phase shift. The direct summing configuration approaches ideal cycle-by-cycle control over the output voltage since there is no conventional error amp in the feedback path.

The device operates in PWM mode using a fixed-frequency, current-mode operation. The current-mode feedback loop regulates peak inductor current as a function of the output error signal.

$\overline{\text{SHDN}}$ Input

The $\overline{\text{SHDN}}$ pin provides shutdown control. Connect $\overline{\text{SHDN}}$ to V_{CC} for normal operation. To disable the device, connect $\overline{\text{SHDN}}$ to GND.

Design Procedure

The MAX5025–MAX5028 can operate in a number of DC-DC converter configurations including step-up, single-ended primary inductance converter (SEPIC), and flyback. The following design discussions are limited to step-up, with a complete circuit shown in the *Application Circuits* section.

Setting the Output Voltage

The output voltage of the MAX5027/MAX5028 is fixed at 30V. The output voltage of the MAX5025/MAX5026 is set by two external resistors (R1 and R2, Figure 2 and Figure 3). First select the value of R2 in the 5k Ω to 50k Ω range. R1 is then given by:

500kHz, 36V Output, SOT23, Step-Up DC-DC Converters

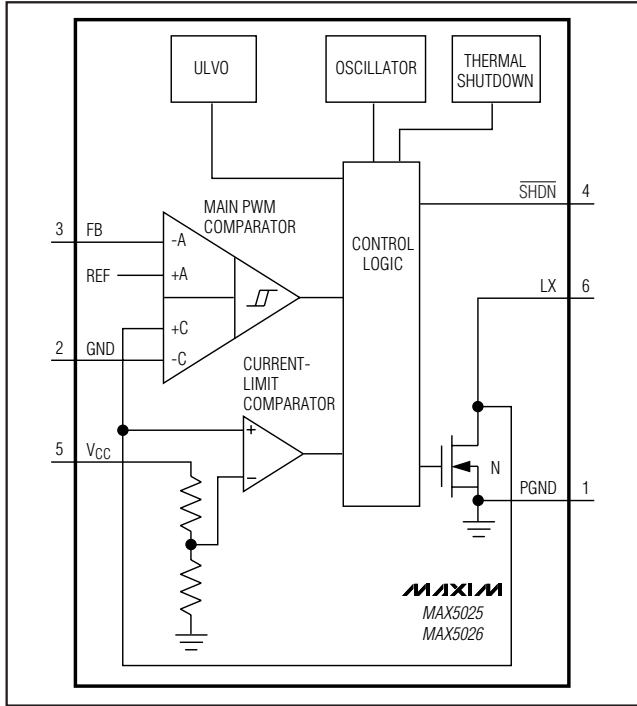

Figure 1. Functional Diagram

$$R1 = R2 \left(\frac{V_{OUT}}{V_{REF}} - 1 \right)$$

where V_{REF} is 1.25V

Determining Peak Inductor Current

If the boost converter remains in the discontinuous mode of operation, then the approximate peak inductor current, I_{LPEAK} , is represented by the formula below:

$$I_{LPEAK} = \sqrt{\frac{2 T_S (V_{OUT} - V_{IN}) I_{OUT}}{\eta L}}$$

where T_S is the period, V_{OUT} is the output voltage, V_{IN} is the input voltage, I_{OUT} is the output current, and η is the efficiency of the boost converter.

Determining the Inductor Value

47 μ H is the recommended inductor value when the output voltage is 30V and the input voltage is 5V. In general, the inductor should have a current rating greater than the current-limit value. For example, the inductor's current rating should be greater than 150mA to support a 4mA output current. Equivalent series resistance (ESR) should be below 1 Ω for reasonable efficiency. Due to the MAX5025-MAX5028's high switching frequency, inductors with a ferrite core or equivalent are recommended. Powdered iron cores are not recommended due to their high losses at frequencies over 500kHz. Table 1 shows a list of vendors and 47 μ H inductor parts.

For 4mA output current and output voltages other than 30V, the inductor can be simply scaled in value according to the following formula:

$$L = \frac{(47\mu H)(V_{OUT} - V_{IN})}{(25V)}$$

Use the following formula to calculate the upper bound of the inductor value at different output voltages and output currents. This is the maximum inductance value for discontinuous mode operation.

$$L_{UPPER} = \frac{V_{IN}^2 (V_{OUT} - V_{IN}) T_S \eta}{2 I_{OUT} V_{OUT}^2}$$

Calculate the lower bound, L_{LOWER} , for the acceptable inductance value using the following formula, which will allow the maximum output current to be delivered without reaching the peak current limit:

$$L_{LOWER} = \frac{2 T_S (V_{OUT} - V_{IN}) I_{OUT}}{\eta \left(\frac{V_{IN}}{5} (260mA) \right)^2}$$

Notice that the switch current limit, $(V_{IN}/5)(260mA)$, is a function of the input voltage, V_{IN} . The current rating of the inductor should be greater than the switch current limit.

Table 1. Inductor Vendors

VENDOR	PHONE	FAX	PART NUMBER OF 47 μ H INDUCTOR
Coilcraft	847-639-6400	847-639-1469	DT1608C-473
Sumida	847-545-6700	847-545-6720	CDRH4D28-470
Toko	847-297-0070	847-699-7864	A915BY-470M

500kHz, 36V Output, SOT23, Step-Up DC-DC Converters

For a design in which $V_{IN} = 5V$, $V_{OUT} = 30V$, $I_{OUT} = 4mA$, $\eta = 0.5$, and $T_S = 2\mu s$,

$L_{UPPER} = 87\mu H$

and

$L_{LOWER} = 12\mu H$.

For a worst-case scenario in which $V_{IN} = 4.75V$, $V_{OUT} = 29V$, $I_{OUT} = 4.4mA$, $\eta = 0.5$, and $T_S = 1.25\mu s$,

$L_{UPPER} = 46\mu H$

and

$L_{LOWER} = 9\mu H$.

The choice of $47\mu H$ as the recommended inductance value is reasonable given the worst-case scenario above. In general, the higher the inductance, the lower the switching noise. Load regulation is also better with higher inductance.

Diode Selection

The MAX5025-MAX5028's high switching frequency demands a high-speed rectifier. Schottky diodes are recommended for most applications because of their fast recovery time and low forward-voltage drop. Ensure that the diode's peak current rating is greater than or equal to the peak inductor current. Also, the diode reverse breakdown voltage must be greater than V_{OUT} . Table 2 lists diode vendors.

Table 2. Schottky Diode Vendors

VENDOR	PHONE	FAX	PART NUMBERS
Comchip	510-657-8671	510-657-8921	CDBS1045
Panasonic	408-942-2912	408-946-9063	MA2Z785
ST-Microelectronics	602-485-6100	602-486-6102	TMMBAT48
Vishay-Telefunken	402-563-6866	402-563-6296	BAS382
Zetex	631-360-2222	631-360-8222	ZHCS500

Table 3. Capacitor Table

COMPANY	PHONE	FAX	PART NUMBERS
Murata	814-237-1431	814-238-0490	GRM42-2X7R105K050AD (1 μF capacitor)
			GRM32-1210R71C475R (4.7 μF capacitor)
Taiyo Yuden	408-573-4150	408-573-4159	UMK325BJ105KH (1 μF capacitor)
			EMK316BJ475ML (4.7 μF capacitor)
TDK	847-803-6100	847-803-6296	C3225X7R1H155K (1.5 μF capacitor)
			C3225X7R1H105K (1 μF capacitor)

Capacitor Selection

Output Filter Capacitor

The output filter capacitor should be $1\mu F$ or greater. To achieve low output ripple, a capacitor with low ESR, low ESL, and high capacitance value should be selected.

For very low output ripple applications, the output of the boost converter can be followed by an RC filter to further reduce the ripple. Figure 3 shows a 100Ω , $1\mu F$ filter used to reduce the switching output ripple to $1mV_{p-p}$.

X7R ceramic capacitors are better for this boost application because of their low ESR and tighter tolerance over temperature than the Y5V ceramic capacitors. Table 3 below lists manufacturers of recommended capacitors.

Input Capacitor

Bypass V_{CC} with a $4.7\mu F$ ceramic capacitor as close to the IC as is practical.

Applications Information

Layout Considerations

The MAX5025-MAX5028 switch at high speed, mandating careful attention to layout for optimum performance. Protect sensitive analog grounds by using a star ground configuration. Minimize ground noise by connecting GND, PGND, the input bypass-capacitor ground lead, and the output-filter ground lead to a single point (star ground configuration). Also, minimize

500kHz, 36V Output, SOT23, Step-Up DC-DC Converters

trace lengths to reduce stray capacitance, trace resistance, and radiated noise. The trace between the output voltage-divider (MAX5025/MAX5026) and the FB pin must be kept short, as well as the trace between GND and PGND.

Inductor Layout

The shielded drum type inductors have a small air gap around the top and bottom periphery. The incident fringing magnetic field from this air gap to the copper plane on the PC board tends to reduce efficiency. This is a result of the induced eddy currents on the copper plane. To minimize this effect, avoid laying out any copper planes under the mounting area of these inductors.

30V Boost Application Circuit

Figures 2 and 3 show the MAX5025/MAX5026 operating in a 30V boost application. Figure 3 has an RC filter to reduce noise at the output. These circuits provide output currents greater than 4mA with an input voltage of 5V or greater. They are designed by following the *Design Procedure* section. Operating characteristics of these circuits are shown in the *Typical Operating Characteristics* section.

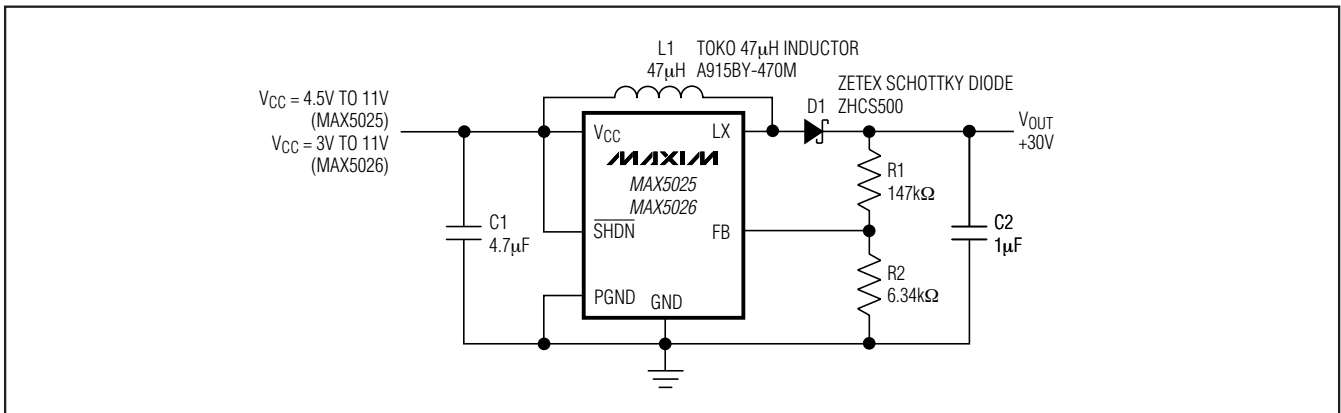

Figure 2. Adjustable 30V Output Circuit

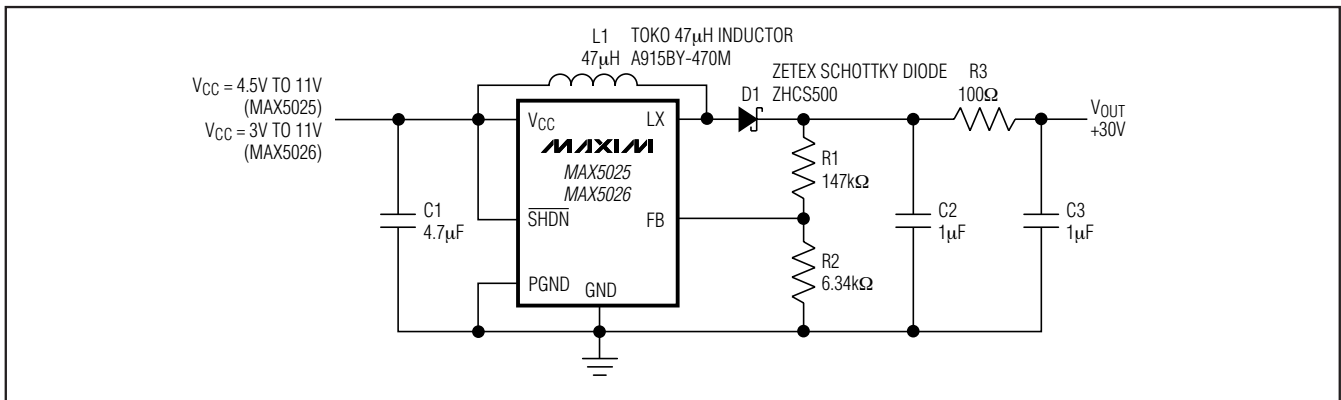

Figure 3. Adjustable 30V Output Circuit with RC Filter

500kHz, 36V Output, SOT23, Step-Up DC-DC Converters

Selector Guide

PART	OUTPUT	FREQUENCY TOLERANCE	FB SET POINT TOLERANCE	INPUT VOLTAGE
MAX5025	Adjustable	-31% to +100%	±5%	4.5V to 11V
MAX5026	Adjustable	-18% to +34%	±3%	3V to 11V
MAX5027	Fixed 30V	-31% to +100%	±5%	4.5V to 11V
MAX5028	Fixed 30V	-18% to +34%	±3%	3V to 11V

Chip Information

TRANSISTOR COUNT: 365
 PROCESS: BiCMOS

Package Information

For the latest package outline information and land patterns, go to www.maxim-ic.com/packages.

PACKAGE TYPE	PACKAGE CODE	DOCUMENT NO.
6 SOT23	S8-2	21-0058

500kHz, 36V Output, SOT23, Step-Up DC-DC Converters

Revision History

REVISION NUMBER	REVISION DATE	DESCRIPTION	PAGES CHANGED
0	10/01	Initial release	—
1	12/01	Released the MAX5027	1
2	3/09	Revised the <i>Absolute Maximum Ratings</i> section.	2

MAX5025-MAX5028

Maxim cannot assume responsibility for use of any circuitry other than circuitry entirely embodied in a Maxim product. No circuit patent licenses are implied. Maxim reserves the right to change the circuitry and specifications without notice at any time.

Maxim Integrated Products, 120 San Gabriel Drive, Sunnyvale, CA 94086 408-737-7600 _____ 13