



# 16-Port, 5.5V Constant-Current LED Driver with LED Fault Detection and Watchdog

MAX6979

## General Description

The MAX6979 serial-interfaced LED driver provides 16 open-drain, constant-current-sinking LED driver outputs rated at 5.5V. The MAX6979 operates from a 3V to 5.5V supply. The MAX6979 supply and the LEDs' supply can power up in any order. The constant-current outputs are programmed together to up to 55mA using a single external resistor. The MAX6979 operates with a 25Mb, industry-standard, 4-wire serial interface.

The MAX6979 includes circuitry that automatically detects open-circuit LEDs. Fault status is loaded into the serial-interface shift register when LE goes high and is automatically shifted out on DOUT when the next data transmission is shifted in.

The MAX6979 includes a fail-safe feature for safety-related applications, which blanks the display if the serial interface fails. If the serial interface becomes inactive for more than 1s, all driver output latches are automatically cleared. This turns off all LEDs connected to the outputs. The shift register data is not disturbed. The outputs remain off until the driver output latches are updated with data turning them on, so recovery is automatic if the transmission failure is temporary. The watchdog function requires no software change to the application driving the MAX6979.

The MAX6979 uses the industry-standard shift-register-plus-latch-type serial interface. The driver accepts data shifted into a 16-bit shift register using data input DIN and clock input CLK. Input data appears at the output DOUT 16 clock cycles later to allow cascading of multiple MAX6979s. The latch-enable input, LE, loads the 16 bits of shift-register data into a 16-bit output latch to set which LEDs are on and which are off. The output-enable input,  $\overline{OE}$ , gates all 16 outputs on and off, and is fast enough to be used as a PWM input for LED intensity control.

The MAX6979 is one of a family of 12 shift-register-plus-latch-type LED drivers. The family includes 8-port and 16-port types, with 5.5V- or 36V-rated LED outputs, with and without open-circuit LED detection and watchdog. All versions operate from a 3V to 5.5V supply, and are specified over the -40°C to +125°C temperature range.

## Applications

- Variable Message Signs
- Marquee Displays
- Point-of-Order Signs
- Traffic Signs
- Gaming Features
- Architectural Lighting

## Features

- ◆ 25Mb Industry-Standard, 4-Wire Serial Interface at 5V
- ◆ 3V to 5.5V Logic Supply
- ◆ 16 Constant-Current LED Outputs Rated at 5.5V
- ◆ Up to 55mA Continuous Current per Output
- ◆ Output Current Programmed by Single Resistor
- ◆ 3% Current Matching Between Outputs
- ◆ 6% Current Matching Between ICs
- ◆ Watchdog Clears Display if Interface Fails
- ◆ Reports Open-Circuit LED Faults
- ◆ High-Dissipation, 24-Pin Packages
- ◆ -40°C to +125°C Temperature Range

## Ordering Information

PART	TEMP RANGE	PIN-PACKAGE
MAX6979AUG+	-40°C to +125°C	24 TSSOP
MAX6979APG+	-40°C to +125°C	24 PDIP

+Denotes a lead(Pb)-free/RoHS-compliant package.

Typical Application Circuit and Selector Guide appear at end of data sheet.

## Pin Configuration

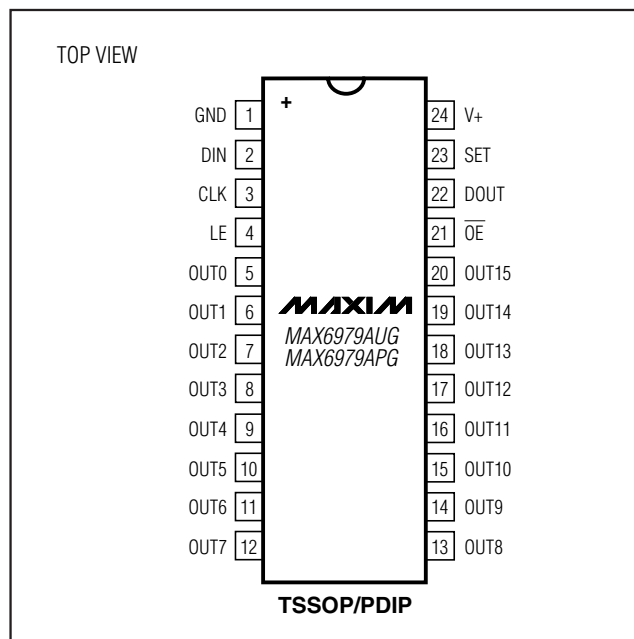

# 16-Port, 5.5V Constant-Current LED Driver with LED Fault Detection and Watchdog

## ABSOLUTE MAXIMUM RATINGS

Voltage (with respect to GND)	Operating Temperature Range	-40°C to +125°C
V+ .....-0.3V to +6V	Junction Temperature	+150°C
OUT_ .....-0.3V to +6V	Storage Temperature Range	-65°C to +150°C
DIN, CLK, LE, $\overline{OE}$ , SE .....-0.3V to (V+ + 0.3V)	Lead Temperature (soldering, 10s)	+300°C
DOUT_ Current .....±10mA	Soldering Temperature (reflow)	
OUT_ Sink Current .....60mA	Lead(Pb)-free packages	+260°C
Total GND Current .....960mA	Packages containing lead(Pb)	+240°C
Continuous Power Dissipation (T <sub>A</sub> = +70°C)		
24-Pin PDIP (derate 13.3mW/°C over +70°C).....1067mW		
24-Pin TSSOP (derate 12.2mW/°C over +70°C) .....975mW		

Stresses beyond those listed under "Absolute Maximum Ratings" may cause permanent damage to the device. These are stress ratings only, and functional operation of the device at these or any other conditions beyond those indicated in the operational sections of the specifications is not implied. Exposure to absolute maximum rating conditions for extended periods may affect device reliability.

## ELECTRICAL CHARACTERISTICS

(Typical Operating Circuit, V+ = 3V to 5.5V, T<sub>A</sub> = T<sub>MIN</sub> to T<sub>MAX</sub>, unless otherwise noted. Typical values are at V+ = 5V, T<sub>A</sub> = +25°C.)  
(Note 1)

PARAMETER	SYMBOL	CONDITIONS	MIN	TYP	MAX	UNITS
Operating Supply Voltage	V+		3.0		5.5	V
Output Voltage	V <sub>OUT</sub>				5.5	V
Standby Current (Interface Idle, All Output Ports High Impedance, R <sub>SET</sub> = 360Ω)	I <sub>+</sub>	All logic inputs at V+ or GND, DOUT unloaded		5.7	8	mA
Standby Current (Interface Running, All Output Ports High Impedance, R <sub>SET</sub> = 360Ω)	I <sub>+</sub>	f <sub>CLK</sub> = 5MHz, $\overline{OE}$ = V+, DIN and LE = V+ or GND, DOUT unloaded		6	8.5	mA
Supply Current (Interface Idle, All Output Ports Active Low, R <sub>SET</sub> = 360Ω)	I <sub>+</sub>	All logic inputs at V+ or GND, DOUT unloaded		18	25	mA
Input High Voltage DIN, CLK, LE, $\overline{OE}$	V <sub>IH</sub>		0.7 x V+			V
Input Low Voltage DIN, CLK, LE, $\overline{OE}$	V <sub>IL</sub>				0.3 x V+	V
Hysteresis Voltage DIN, CLK, LE, $\overline{OE}$	ΔV <sub>I</sub>			0.8		V
Input Leakage Current DIN, CLK, LE, $\overline{OE}$	I <sub>IH</sub> , I <sub>IL</sub>		-1		+1	μA
Output High Voltage DOUT	V <sub>OH</sub>	I <sub>SOURCE</sub> = 4mA	V+ -0.5V			V
Output Low Voltage	V <sub>OL</sub>	I <sub>SINK</sub> = 4mA			0.5	V
Output Current OUT	I <sub>OUT</sub>	V+ = 3V to 5.5V, V <sub>OUT</sub> = 0.5V to 2.5V, R <sub>SET</sub> = 360Ω	37	50	61	mA
Output Leakage Current OUT	I <sub>LEAK</sub>	$\overline{OE}$ = V+, V <sub>OUT</sub> = V+			1	μA
Watchdog Timeout	t <sub>WD</sub>		0.1	1	2.5	s

# 16-Port, 5.5V Constant-Current LED Driver with LED Fault Detection and Watchdog

MAX6979

## 5V TIMING CHARACTERISTICS

(Typical Operating Circuit,  $V_+ = 4.5V$  to  $5.5V$ ,  $T_A = T_{MIN}$  to  $T_{MAX}$ , unless otherwise noted.) (Notes 1 and 2)

PARAMETER	SYMBOL	CONDITIONS	MIN	TYP	MAX	UNITS
CLK Clock Period	$t_{CP}$		40			ns
CLK Pulse-Width High	$t_{CH}$		19			ns
CLK Pulse-Width Low	$t_{CL}$		19			ns
DIN Setup Time	$t_{DS}$		4			ns
DIN Hold Time	$t_{DH}$		8			ns
DOOUT Propagation Delay	$t_{DO}$		12		32	ns
DOOUT Rise and Fall Time	$t_{DR}, t_{DF}$	$C_{DOOUT} = 10pF, 20\%$ to $80\%$			10	ns
LE Setup Time	$t_{LS}$		10			ns
LE Rising to OUT Rising Delay	$t_{LRR}$	(Note 2)			100	ns
LE Rising to OUT Falling Delay	$t_{LRF}$	(Note 2)			300	ns
CLK Rising to OUT Rising Delay	$t_{CRR}$	(Note 2)			100	ns
CLK Rising to OUT Falling Delay	$t_{CRF}$	(Note 2)			310	ns
$\overline{OE}$ Rising to OUT Rising Delay	$t_{\overline{OE}H}$				100	ns
$\overline{OE}$ Falling to OUT Falling Delay	$t_{\overline{OE}L}$				320	ns
LED Output OUT Turn-On Fall Time	$t_f$	80% to 20%; pullup resistor = $65\Omega$			120	ns
LED Output OUT Turn-Off Rise Time	$t_r$	20% to 80%; pullup resistor = $65\Omega$			120	ns

# 16-Port, 5.5V Constant-Current LED Driver with LED Fault Detection and Watchdog

## 3.3V TIMING CHARACTERISTICS

(Typical Operating Circuit,  $V_+ = 3V$  to  $5.5V$ ,  $T_A = T_{MIN}$  to  $T_{MAX}$ , unless otherwise noted.) (Notes 1 and 2)

PARAMETER	SYMBOL	CONDITIONS	MIN	TYP	MAX	UNITS
CLK Clock Period	$t_{CP}$		52			ns
CLK Pulse-Width High	$t_{CH}$		24			ns
CLK Pulse-Width Low	$t_{CL}$		24			ns
DIN Setup Time	$t_{DS}$		4			ns
DIN Hold Time	$t_{DH}$		8			ns
DOUT Propagation Delay	$t_{DO}$		12		50	ns
DOUT Rise and Fall Time		$C_{DOUT} = 10pF, 20\%$ to $80\%$			12	ns
LE Setup Time	$t_{LS}$		15			ns
LE Rising to OUT Rising Delay					120	ns
LE Rising to OUT Falling Delay					310	ns
CLK Rising to OUT Rising Delay					120	ns
CLK Rising to OUT Falling Delay					330	ns
$\overline{OE}$ Rising to OUT Rising Delay	$t_{\overline{OE}H}$				120	ns
$\overline{OE}$ Falling to OUT Falling Delay	$t_{\overline{OE}L}$				330	ns
LED Output OUT Turn-On Fall Time	$t_f$	80% to 20%			120	ns
LED Output OUT Turn-Off Rise Time	$t_r$	20% to 80%			120	ns

**Note 1:** All parameters tested at  $T_A = +25^\circ C$ . Specifications overtemperature are guaranteed by design.

**Note 2:** See Figure 3.

## Typical Operating Characteristics

( $T_A = +25^\circ C$ , unless otherwise noted.)

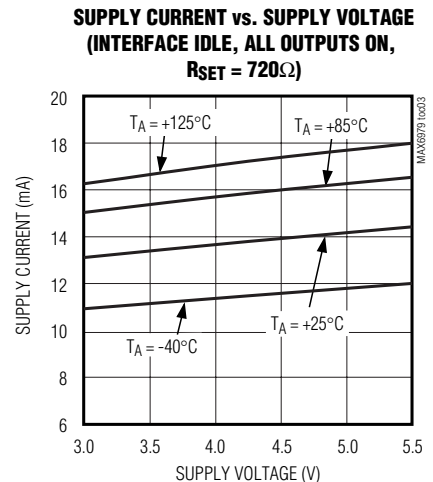
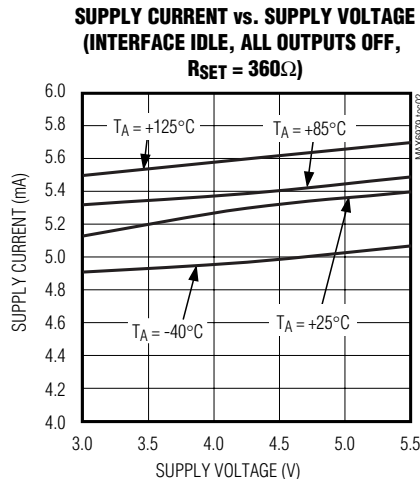
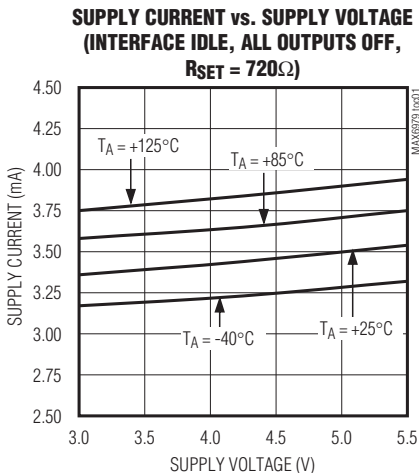

# 16-Port, 5.5V Constant-Current LED Driver with LED Fault Detection and Watchdog

## Typical Operating Characteristics (continued)

( $T_A = +25^\circ\text{C}$ , unless otherwise noted.)

**SUPPLY CURRENT vs. SUPPLY VOLTAGE**  
(INTERFACE IDLE, ALL OUTPUTS ON,  $R_{SET} = 360\Omega$ )

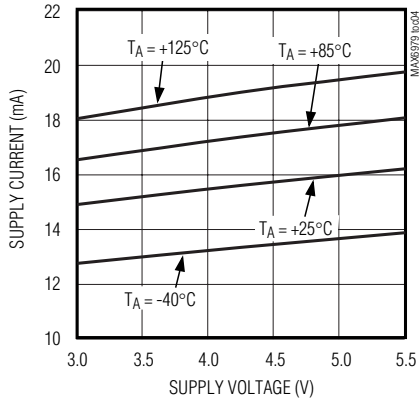

**PORT OUTPUT CURRENT vs. PORT OUTPUT VOLTAGE**  
( $R_{SET} = 720\Omega$ ,  $V_+ = 3.3\text{V}$ )

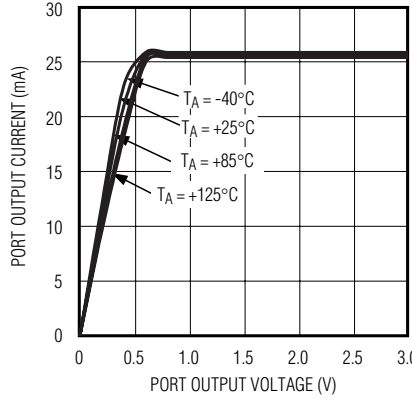

**PORT OUTPUT CURRENT vs. PORT OUTPUT VOLTAGE**  
( $R_{SET} = 360\Omega$ ,  $V_+ = 3.3\text{V}$ )

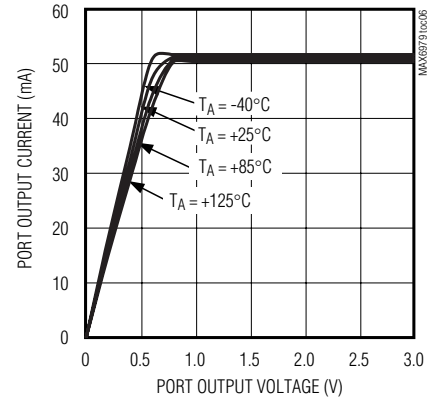

**PORT OUTPUT CURRENT vs. PORT OUTPUT VOLTAGE**  
( $R_{SET} = 720\Omega$ ,  $V_+ = 5.0\text{V}$ )

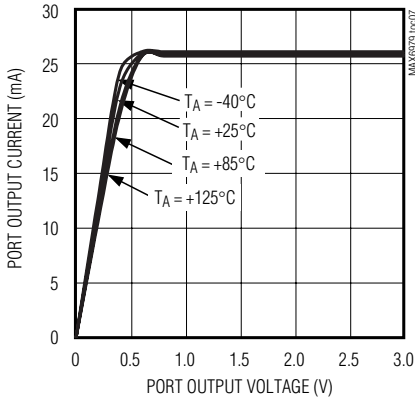

**PORT OUTPUT CURRENT vs. PORT OUTPUT VOLTAGE**  
( $R_{SET} = 360\Omega$ ,  $V_+ = 5.0\text{V}$ )

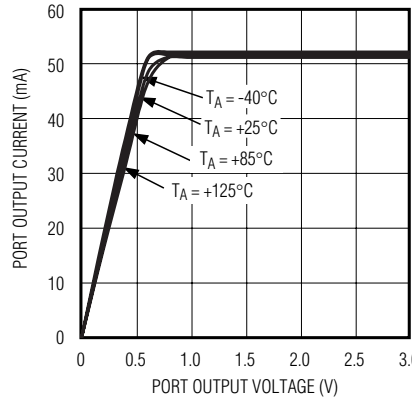

**PORT OUTPUT CURRENT vs. SUPPLY VOLTAGE**  
( $R_{SET} = 720\Omega$ ,  $V_{OUT} = 2\text{V}$ )

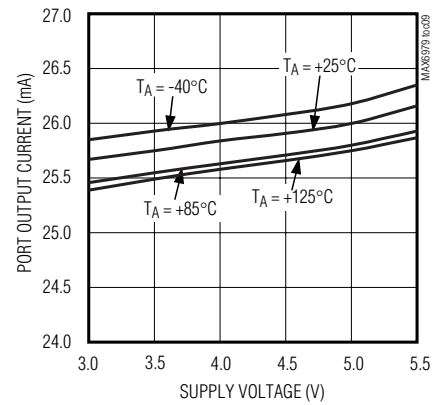

**PORT OUTPUT CURRENT vs. SUPPLY VOLTAGE**  
( $R_{SET} = 360\Omega$ ,  $V_{OUT} = 2\text{V}$ )

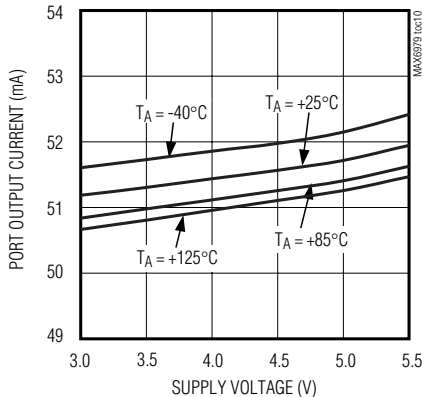

**PORT OUTPUT CURRENT vs.  $R_{SET}$  RESISTANCE**  
( $V_+ = 5.0\text{V}$ )

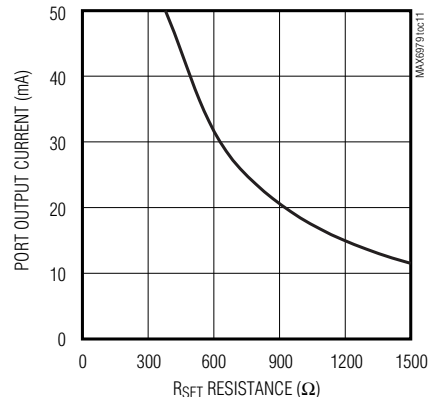

MAX6979

# 16-Port, 5.5V Constant-Current LED Driver with LED Fault Detection and Watchdog

## Pin Description

PIN	NAME	FUNCTION
1	GND	Ground
2	DIN	Serial-Data Input. Data is loaded into the internal 16-bit shift register on CLK's rising edge.
3	CLK	Serial-Clock Input. Data is loaded into the internal 16-bit shift register on CLK's rising edge.
4	LE	Load-Enable Input. Data is loaded transparently from the internal shift register(s) to the output latch(es) while LE is high. Data is latched into the output latch(es) on LE's falling edge, and retained while LE is low.
5–20	OUT0–OUT15	LED Driver Outputs. OUT0 to OUT15 are open-drain, constant-current-sinking outputs rated to 5.5V.
21	$\overline{OE}$	Output Enable Input. High forces outputs OUT0 to OUT15 high impedance without altering the contents of the output latches. Low enables outputs OUT0 to OUT15 to follow the state of the output latches.
22	DOUT	Serial-Data Output. Data is clocked out of the 16-bit internal shift register to DOUT on CLK's rising edge.
23	SET	LED Current Setting. Connect SET to GND through a resistor ( $R_{SET}$ ) to set the maximum LED current.
24	V+	Positive Supply Voltage. Bypass V+ to GND with a 0.1 $\mu$ F ceramic capacitor.

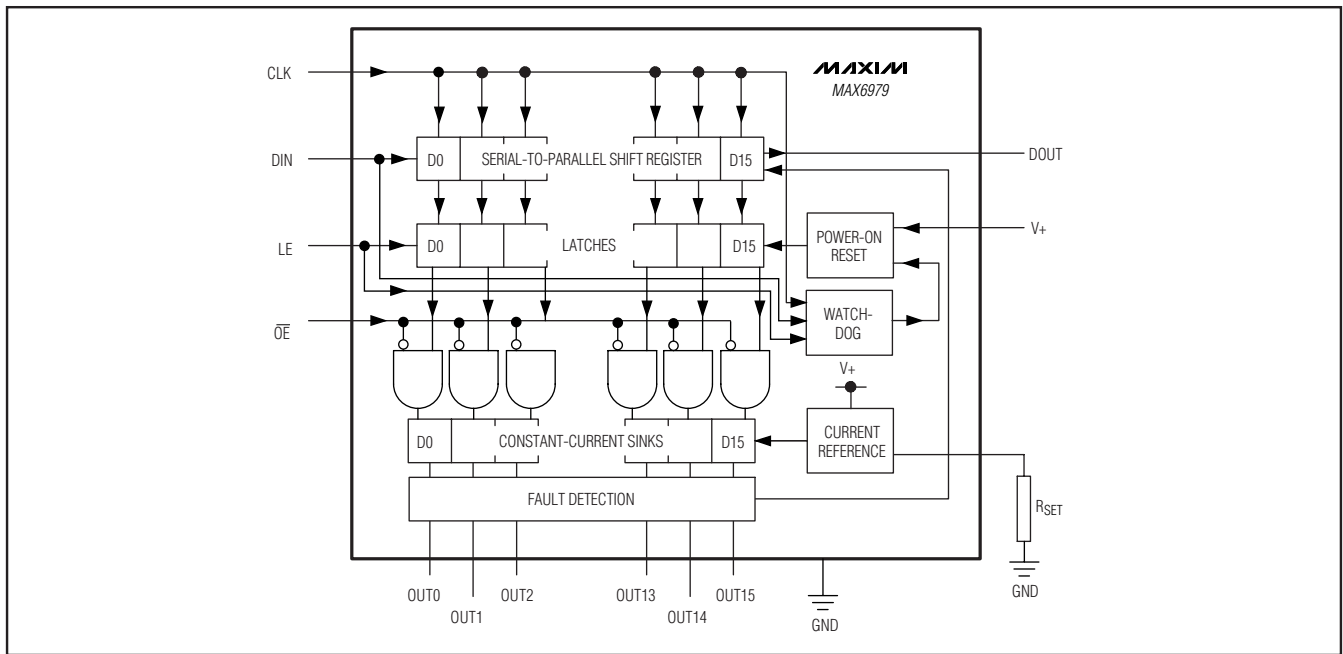

Figure 1. MAX6979 Block Diagram

## Detailed Description

The MAX6979 LED driver comprises a 4-wire serial interface driving eight constant-current sinking open-drain output ports. The outputs drive LEDs in either static or multiplex applications (Figure 1). The constant-current outputs are guaranteed for current accuracy

not only with chip-supply voltage variations (5V  $\pm$ 10% and 3V to 5.5V), but also over a realistic range of driver output voltage drop (0.5V to 2.5V). The drivers use current-sensing feedback circuitry (not simple current mirrors) to ensure very small current variations over the full allowed range of output voltage (see the *Typical Operating Characteristics*).

# 16-Port, 5.5V Constant-Current LED Driver with LED Fault Detection and Watchdog

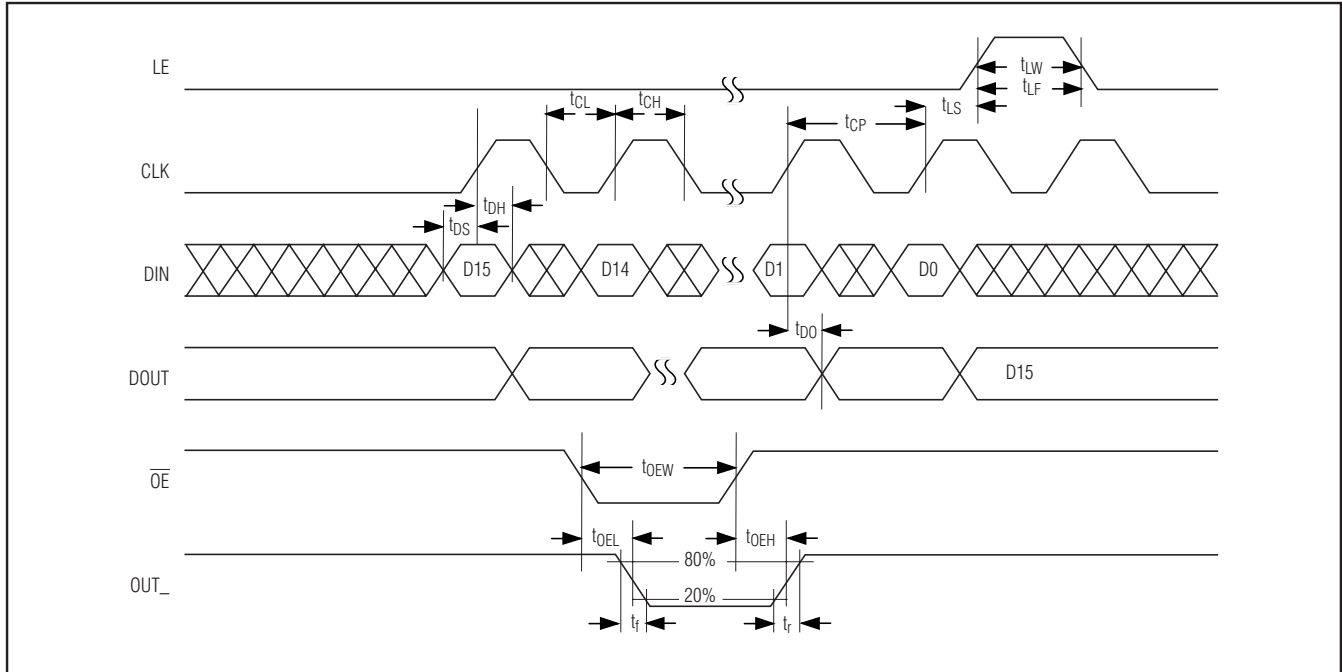

Figure 2. 4-Wire Serial-Interface Timing Diagram

The 4-wire serial interface comprises a 16-bit shift register and a 16-bit transparent latch. The shift register is written through a clock input CLK and a data input DIN and the data propagates to a data output DOUT. The data output allows multiple drivers to be cascaded and operated together. The contents of the 16-bit shift register are loaded into the transparent latch through a latch-enable input LE. The latch is transparent to the shift register outputs when high, and latches the current state on the falling edge of LE.

Each driver output is an open-drain, constant-current sink that should be connected to the cathode of either a single LED or a series string of multiple LEDs. The LED anode can be connected to a supply voltage of up to 5.5V, independent of the MAX6979 supply,  $V_+$ . The constant-current capability is up to 55mA per output, set for all 16 outputs by an external resistor, RSET.

### 4-Wire Serial Interface

The serial interface on the MAX6979 is a 4-wire serial interface using four inputs (DIN, CLK, LE,  $\overline{OE}$ ) and a data output (DOUT). This interface is used to write display data to the MAX6979. The serial-interface data word length is 16 bits, D0–D15. See Figure 2.

The functions of the five interface pins are as follows. DIN is the serial-data input, and must be stable when it

is sampled on the rising edge of CLK. Data is shifted in, MSB first. This means that data bit D15 is clocked in first, followed by 15 more data bits, finishing with the LSB D0.

CLK is the serial-clock input, which shifts data at DIN into the MAX6979 16-bit shift register on its rising edge.

LE is the latch load input of the MAX6979, which transfers data from the MAX6979 16-bit shift register to its 16-bit latch when LE is high (transparent latch), and latches the data on the falling edge of LE (Figure 2).

The fourth input provides output-enable control of the output drivers.  $\overline{OE}$  is high to force outputs OUT0–OUT15 high impedance, without altering the contents of the output latches, and low to enable outputs OUT0–OUT15 to follow the state of the output latches.

$\overline{OE}$  is independent of the operation of the serial interface. Data can be shifted into the serial-interface shift register and latched regardless of the state of  $\overline{OE}$ .

DOUT is the serial-data output, which shifts data out from the MAX6979's 16-bit shift register on the rising edge of CLK. Data at DIN is propagated through the shift register and appears at DOUT 16 clock cycles later. See Figure 2.

# 16-Port, 5.5V Constant-Current LED Driver with LED Fault Detection and Watchdog

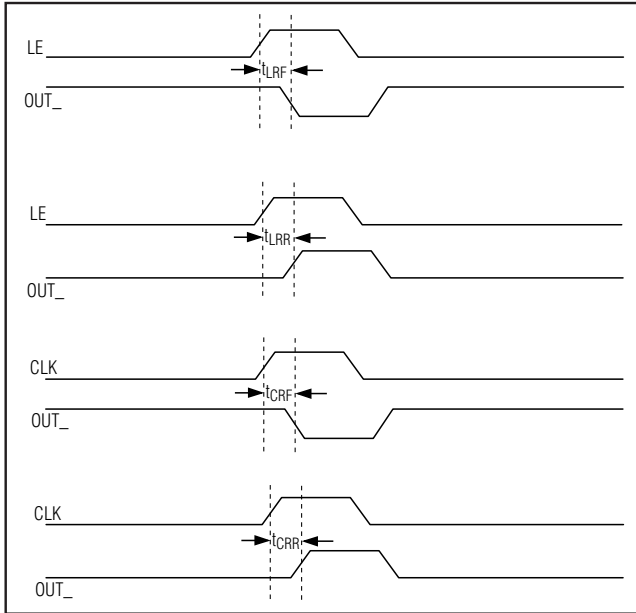

Figure 3. LE and CLK to OUT\_ Timing

## Watchdog

The MAX6979 includes a watchdog circuit that monitors the CLK, DIN, and LE inputs. If there is no transition on all of these inputs for nominally 1s, then the output latches are cleared and outputs OUT0–OUT15 go high impedance like the initial power-up condition. This turns off all LEDs connected to the outputs. The shift-register data does not change, just the output-latch data.

The watchdog is intended to be used as a fail-safe feature for applications, which prefer a blank display to an incorrect display if the serial interface fails. When the watchdog triggers, the outputs remain off until the driver output latches are updated with data turning them on. Recovery is therefore automatic if the transmission failure is temporary, because the MAX6979 does not lock up in the watchdog timeout state. The MAX6979 operates correctly when the serial interface is next activated, and the watchdog circuit is reset and starts monitoring the serial interface again. The watchdog function requires no software change to the application driving the MAX6979.

## LED Fault Detection

The MAX6979 includes circuitry that detects open-circuit LEDs automatically. An open-circuit fault occurs when an output is programmed to sink current but less than about 50% of the programmed current flows. Open circuits are checked just after the falling edge of

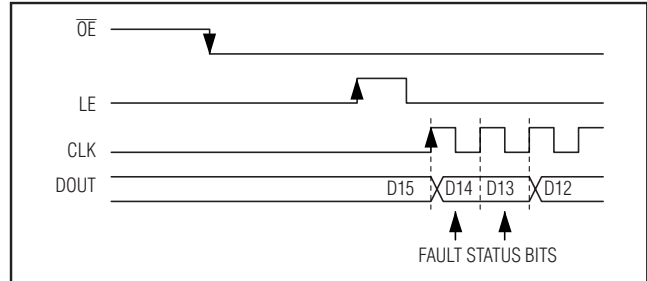

Figure 4. Fault Timing Diagram

$\overline{OE}$ . The fault data is latched on the rising edge of LE and is shifted out when new LED data is loaded into the output latches from the shift register. If one or more output ports are detected with an open-circuit fault, the D14 and D13 bits of DOUT go high. If no open-circuit faults are detected, the D14 and D13 are set to low. The data in the other 14 bit positions in DOUT are not altered.

Fault status is shifted out on DOUT when the next data transmission is shifted in after the rising edge of LE. LE is normally taken high after all 16 bits of new LED data have been clocked into the shift register(s), and then DOUT outputs data bit D15. On the next two rising edges of CLK, the 2 fault status bits, D14 and D13, are clocked out in that order, followed by the remaining 13 unchanged data bits D12 to D0.

A typical fault-detecting application tests all the-shifted out data. Bits D0–D12 and D15 are checked against the originally transmitted data to check data-link integrity. Bits D13 and D14 are checked first to see that they contain the same data (validating the status) and second, whether faults are reported or not by the actual logic level.

Figure 4 is the LE and CLK to OUT\_ timing diagram.

## Applications Information

### Selecting External Component R<sub>SET</sub> to Set LED Output Current

The MAX6979 uses an external resistor R<sub>SET</sub> to set the LED current for outputs OUT0–OUT15. The minimum allowed value of R<sub>SET</sub> is 327.3Ω, which sets the output currents to 55mA. The maximum allowed value of R<sub>SET</sub> is 1.5kΩ. The reference value, 360Ω, sets the output currents to 50mA. To set a different output current, use the formula:

$$R_{SET} = 18,000/I_{OUT}$$

where I<sub>OUT</sub> is the desired output current in mA.



# 16-Port, 5.5V Constant-Current LED Driver with LED Fault Detection and Watchdog

Table 1. 4-Wire Serial-Interface Truth Table

SERIAL DATA INPUT DIN	CLOCK INPUT CLK	SHIFT-REGISTER CONTENTS						LOAD INPUT LE	LATCH CONTENTS						BLANKING INPUT OE	OUTPUT CONTENTS					
		D <sub>0</sub>	D <sub>1</sub>	D <sub>2</sub>	...	D <sub>n-1</sub>	D <sub>n</sub>		D <sub>0</sub>	D <sub>1</sub>	D <sub>2</sub>	...	D <sub>n-1</sub>	D <sub>n</sub>		D <sub>0</sub>	D <sub>1</sub>	D <sub>2</sub>	...	D <sub>n-1</sub>	D <sub>n</sub>
H		H	R <sub>1</sub>	R <sub>2</sub>	...	R <sub>n-2</sub>	R <sub>n-1</sub>	—	—	—	—	—	—	—	—	—	—	—	—	—	
L		L	R <sub>1</sub>	R <sub>2</sub>	...	R <sub>n-2</sub>	R <sub>n-1</sub>	—	—	—	—	—	—	—	—	—	—	—	—	—	
X		R <sub>0</sub>	R <sub>1</sub>	R <sub>2</sub>	...	R <sub>n-1</sub>	R <sub>n</sub>	—	—	—	—	—	—	—	—	—	—	—	—	—	
—	—	X	X	X	...	X	X	H	R <sub>0</sub>	R <sub>1</sub>	R <sub>2</sub>	...	R <sub>n-1</sub>	R <sub>n</sub>	—	—	—	—	—	—	
—	—	P <sub>1</sub>	P <sub>2</sub>	P <sub>3</sub>	...	P <sub>n-1</sub>	P <sub>n</sub>	L	P <sub>0</sub>	P <sub>1</sub>	P <sub>2</sub>	...	P <sub>n-1</sub>	P <sub>n</sub>	L	P <sub>0</sub>	P <sub>1</sub>	P <sub>2</sub>	...	P <sub>n-1</sub>	P <sub>n</sub>
—	—	—	—	—	—	—	—	—	X	X	X	...	X	X	H	Hi-Z	Hi-Z	Hi-Z	...	Hi-Z	Hi-Z

L = Low-logic level; H = High-logic level; X = Don't care; P = Present state; R = Previous state

## Computing Power Dissipation

The upper limit for power dissipation ( $P_D$ ) for the MAX6979 is determined from the following equation:

$$P_D = (V_+ \times I_+) + (V_{OUT} \times DUTY \times I_{OUT} \times N)$$

where:

$V_+$  = supply voltage

$I_+$  = operating supply current when sinking  $I_{OUT}$  LED drive current into N outputs

DUTY = PWM duty cycle applied to  $\overline{OE}$

N = number of MAX6979 outputs driving LEDs at the same time (maximum is 16)

$V_{OUT}$  = MAX6979 port output voltage when driving load LED(s)

$I_{OUT}$  = LED drive current programmed by RSET

$P_D$  = power dissipation, in mW if currents are in mA

Dissipation example:

$$I_{OUT} = 47\text{mA}, N = 16, DUTY = 1, \\ V_{OUT} = 2\text{V}, V_+ = 5.25\text{V}$$

$$P_D = (5.25\text{V} \times 25\text{mA}) + (2\text{V} \times 1 \times 47\text{mA} \times 16) = 1.776\text{W}$$

Thus, for a 24-pin TSSOP package ( $T_{JA} = 1/0.0122 = +82^\circ\text{C/W}$  from the *Absolute Maximum Ratings*), the maximum allowed ambient temperature  $T_A$  is given by:

$$T_{J(\text{MAX})} = T_A + (P_D \times T_{JA}) = +150^\circ\text{C} = \\ T_A + (1.776 \times 82^\circ\text{C/W})$$

so  $T_A = +145.6^\circ\text{C}$ .

## Overtemperature Cutoff

The MAX6979 contains an internal temperature sensor that turns off all outputs when the die temperature exceeds approximately  $+165^\circ\text{C}$ . The outputs are enabled again when the die temperature drops below approximately  $+140^\circ\text{C}$ . Register contents are not affected, so when a driver is overdissipating, the external symptom is the load LEDs cycling between on and off as the driver repeatedly overheats and cools, alternately turning the LEDs off and then back on again.

## Power-Supply Considerations

The MAX6979 operates with a chip supply  $V_+$ , and one or more LED supplies. Bypass each supply to GND with a  $0.1\mu\text{F}$  capacitor as close to the MAX6979 as possible. This is normally adequate for static LED driving. For multiplex or PWM applications, it is necessary to add an additional bulk electrolytic capacitor of  $4.7\mu\text{F}$  or more to each supply for every 4 to 16 MAX6979s. The necessary capacitance depends on the LED load current, PWM switching frequency, and serial interface speed. Inadequate  $V_+$  decoupling can cause timing problems, and very noisy LED supplies can affect LED current regulation.

# 16-Port, 5.5V Constant-Current LED Driver with LED Fault Detection and Watchdog

## Selector Guide

PART	NO. OF OUTPUTS	MAX OUTPUT VOLTAGE (V)	MAX OUTPUT CURRENT	LED FAULT DETECTION	WATCHDOG
MAX6968	8	5.5	55mA	—	—
MAX6977				Yes	—
MAX6978				Yes	Yes
MAX6970	8	36		—	—
MAX6981				Yes	—
MAX6980				Yes	Yes
MAX6969	16	5.5		—	—
MAX6984				Yes	—
MAX6979				Yes	Yes
MAX6971	16	36		—	—
MAX6982				Yes	—
MAX6983				Yes	Yes

## Typical Application Circuit

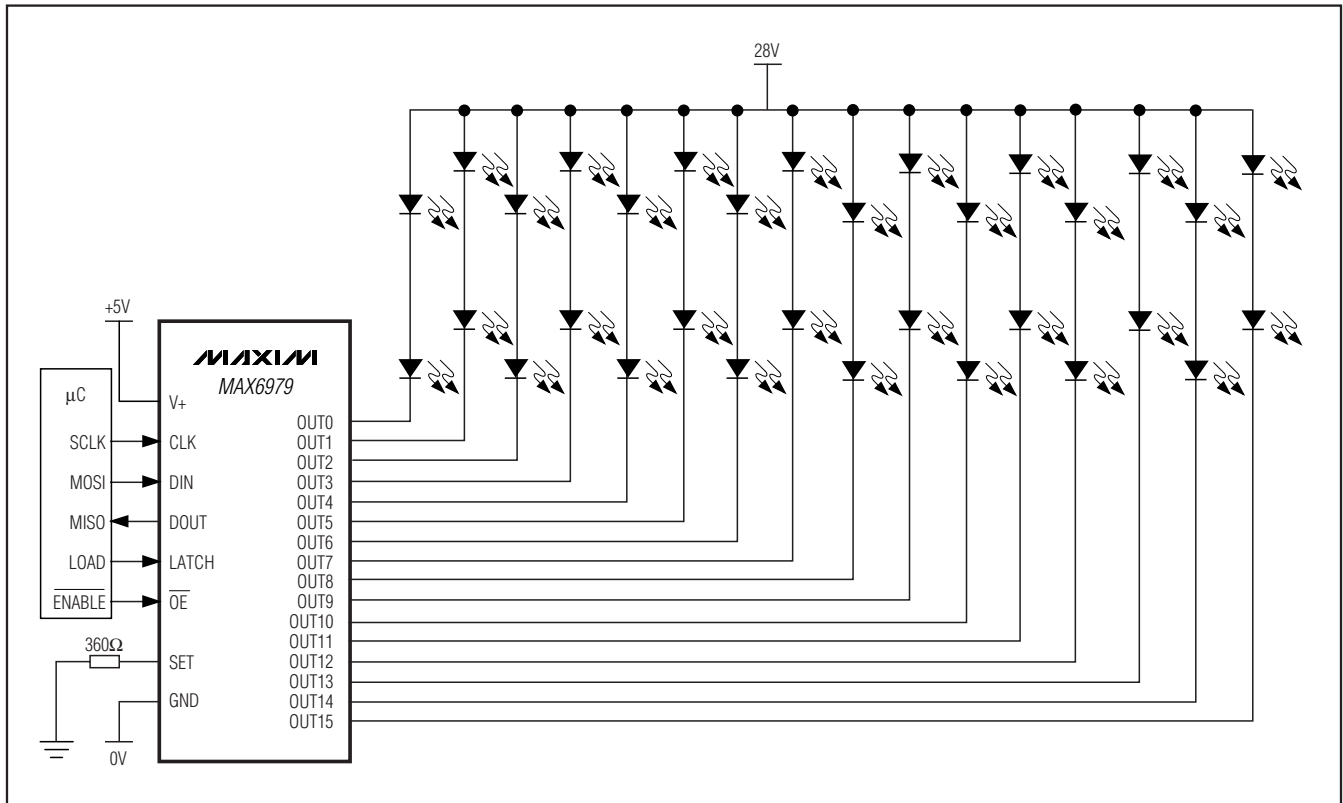

# 16-Port, 5.5V Constant-Current LED Driver with LED Fault Detection and Watchdog

## Chip Information

PROCESS: BICMOS

## Package Information

For the latest package outline information and land patterns, go to [www.maxim-ic.com/packages](http://www.maxim-ic.com/packages). Note that a "+", "#", or "-" in the package code indicates RoHS status only. Package drawings may show a different suffix character, but the drawing pertains to the package regardless of RoHS status.

PACKAGE TYPE	PACKAGE CODE	OUTLINE NO.	LAND PATTERN NO.
24 PDIP	N24+1	<a href="#">21-0043</a>	—
24 TSSOP	U24+1	<a href="#">21-0066</a>	<a href="#">90-0118</a>

MAX6979

# 16-Port, 5.5V Constant-Current LED Driver with LED Fault Detection and Watchdog

## Revision History

REVISION NUMBER	REVISION DATE	DESCRIPTION	PAGES CHANGED
0	5/05	Initial release	—
1	12/10	Updated <i>Ordering Information</i> and <i>Watchdog</i> section	1, 8

Maxim cannot assume responsibility for use of any circuitry other than circuitry entirely embodied in a Maxim product. No circuit patent licenses are implied. Maxim reserves the right to change the circuitry and specifications without notice at any time.

12 \_\_\_\_\_ **Maxim Integrated Products, 120 San Gabriel Drive, Sunnyvale, CA 94086 408-737-7600**