

MAX8863

Pin-Compatible, Low-Dropout, 120 mA Linear Regulator

Delivering up to 120 mA, the MAX8863 is a fixed output, low-dropout linear regulator that operates from a +2.5 V to +6.0 V input range. The 50 μ A supply current remains independent of load, making these devices ideal for battery-operated portable equipment.

The output of the MAX8863 is preset at 3.15 V, 2.84 V, 2.80 V or 1.80 V. (Other output voltage options are available – contact ON Semiconductor for more information.) The MAX8863 is pin-compatible with the Maxim MAX8863 LDO and is available in the SOT-23-5 package.

Features

- Low Cost
- Pin-Compatible with MAX8863
- Stable with Any Type of Capacitors
- Low, 55 mV Dropout Voltage @ 50 mA I_{OUT}
- Low, 50 μ A Operating Supply Current (Even in Dropout)
- 140 μ sec (Typ.) Turn-On Response Time from \overline{SHDN}
- Low, 350 μ V_{RMS} Output Noise
- Miniature External Components
- Thermal Overload Protection
- Output Current Limit
- Low-Power Shutdown Mode

Applications

- Cordless, PCS, and Cellular Telephones
- PCMCIA Cards
- Modems
- Hand-Held Instruments
- Palmtop Computers
- Electronic Planners

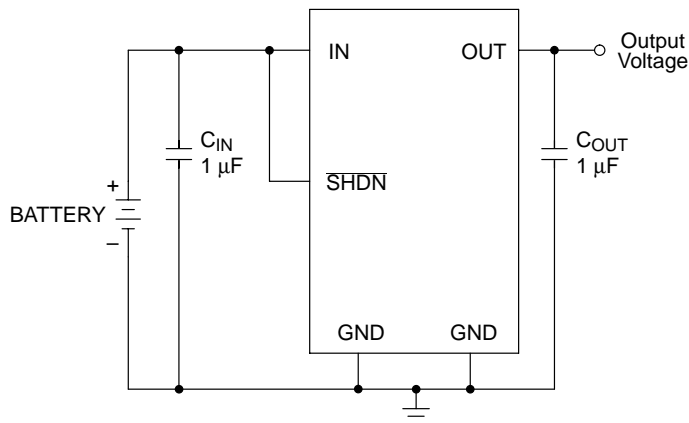
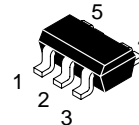

Figure 1. Typical Application



ON Semiconductor™

<http://onsemi.com>



SOT-23
EUK SUFFIX
CASE 1212

PIN CONNECTIONS

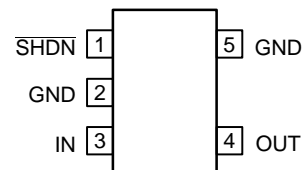

(Top View)

ORDERING INFORMATION

See detailed ordering and shipping information in the package dimensions section on page 9 of this data sheet.

DEVICE MARKING INFORMATION

See general marking information in the device marking section on page 9 of this data sheet.

MAX8863

ABSOLUTE MAXIMUM RATINGS*

Rating	Symbol	Value	Unit
Input Voltage	–	6.5	V
Output Short-Circuit Duration	–	Infinite	–
SET to GND	–	– 0.3 to +6.5	V
SHDN to GND	–	– 6.5 to + 6.5	V
SHDN to IN	–	–6.5 to + 0.3	V
Output Voltage	–	–0.3 to $V_{IN} + 0.3$	V
Continuous Power Dissipation ($T_A = +70^{\circ}\text{C}$) SOT–23–5 (Derate 7.1 mW/ $^{\circ}\text{C}$ above $+70^{\circ}\text{C}$)	–	571	mW
Operating Temperature Range	T_A	–40 to 85	$^{\circ}\text{C}$
Storage Temperature Range	T_{stg}	–65 to +160	$^{\circ}\text{C}$
Lead Temperature (Soldering, 10 Sec.)	–	+300	$^{\circ}\text{C}$
ESD Withstand Voltage Human Body Model (Note 1.)	V_{ESD}	> 2000	V
Latch-Up Performance (Note 2.)	$I_{LATCH-UP}$	420 240	mA
	Positive	420	
	Negative	240	

*Stresses above those listed under “Absolute Maximum Ratings” may cause permanent damage to the device. These are stress ratings only and functional operation of the device at these or any other conditions above those indicated in the operational sections of the specifications is not implied. Exposure to Absolute Maximum Rating conditions for extended periods may affect device reliability.

ELECTRICAL CHARACTERISTICS ($V_{IN} = +3.6\text{ V}$, $\text{GND} = 0\text{ V}$, $T_A = T_{MIN}$ to T_{MAX} , unless otherwise specified. Typical values are at $T_A = +25^{\circ}\text{C}$.) (Note 3.)

Characteristics	Test Conditions	Symbol	Min	Typ	Max	Unit
Input Voltage (Note 4.)	$V_{OUT} \geq 2.5\text{ V}$ $V_{OUT} = 1.8\text{ V}$	V_{IN}	$V_{OUT} + 0.5\text{ V}$ 2.7	– –	6.0 6.0	V
Output Voltage	$0\text{ mA} \leq I_{OUT} \leq 50\text{ mA}$	V_{OUT}				V
	T		3.05	3.15	3.25	
	S		2.75	2.84	2.93	
	R		2.70	2.80	2.88	
	Q		1.745	1.80	1.85	
Maximum Output Current	–	I_{OUT}	120	–	–	mA
Current Limit (Note 5.)	–	I_{LIM}	–	280	–	mA
Input Current	$I_{OUT} = 0$	I_{IN}	–	50	90	μA
Dropout Voltage (Note 6.)	$I_{OUT} = 1.0\text{ mA}$ $I_{OUT} = 50\text{ mA}$ $I_{OUT} = 100\text{ mA}$	–	– – –	1.1 55 110	– 120 240	mV
Line Regulation	$V_{IN} = V_{OUT} + 0.5\text{ V}$ to 6.0 V $I_{OUT} = 1.0\text{ mA}$	ΔV_{LNR}	–0.10 –	.001 –	0.10 –	%/V
Load Regulation	$I_{OUT} = 0\text{ mA}$ to 50 mA	ΔV_{LDR}	–	0.01	0.040	%/mA
Output Voltage Noise	10 Hz to 1.0 MHz $C_{OUT} = 1.0\text{ }\mu\text{F}$ $C_{OUT} = 100\text{ }\mu\text{F}$	–	– –	350 220	– –	μVRMS
Wake Up Time (from Shutdown Mode)	$V_{IN} = 3.6\text{ V}$ $C_{IN} = 1.0\text{ }\mu\text{F}$, $C_{OUT} = 1.0\text{ }\mu\text{F}$ $I_L = 30\text{ mA}$, (See Fig. 1)	t_{WK}	–	10	–	μsec
Settling Time (from Shutdown Mode)	$V_{IN} = 3.6\text{ V}$ $C_{IN} = 1.0\text{ }\mu\text{F}$, $C_{OUT} = 1.0\text{ }\mu\text{F}$ $I_L = 30\text{ mA}$, (See Fig. 1)	t_S	–	140	–	μsec

1. Tested to EIA/JESD22–A114–A
2. Tested to EIA/JESD78
3. Limits are 100% production tested at $T_A = +25^{\circ}\text{C}$. Limits over the operating temperature range are guaranteed through correlation using Statistical Quality Control (SQC) Methods.
4. Guaranteed by line regulation test.
5. Not tested. For design purposes, the current limit should be considered 150 mA minimum to 410 mA maximum.
6. The dropout voltage is defined as ($V_{IN} - V_{OUT}$) when V_{OUT} is 100 mV below the value of V_{OUT} for $V_{IN} = V_{OUT} + 2.0\text{ V}$.

MAX8863

ELECTRICAL CHARACTERISTICS (continued) ($V_{IN} = +3.6\text{ V}$, $GND = 0\text{ V}$, $T_A = T_{MIN}$ to T_{MAX} , unless otherwise specified. Typical values are at $T_A = +25^\circ\text{C}$.) (Note 7.)

Characteristics	Test Conditions	Symbol	Min	Typ	Max	Unit
Shutdown						
SHDN Input Threshold	–	V_{IH} V_{IL}	2.0 –	– –	– 0.4	V
SHDN Input Bias Current	$V_{SHDN} = V_{IN}$ $T_A = +25^\circ\text{C}$ $T_A = T_{MAX}$	I_{SHDN}	– –	0 50	100 –	nA
Shutdown Supply Current	$V_{OUT} = 0\text{ V}$ $T_A = +25^\circ\text{C}$ $T_A = T_{MAX}$	I_{QSHDN}	– –	.002 0.02	1.0 –	μA
Shutdown to Output Discharge Delay	$C_{OUT} = 1.0\ \mu\text{F}$, No Load to 10% of V_{OUT}	–	–	1.0	–	msec

Thermal Protection

Thermal Shutdown Temperature	–	T_{SHDN}	–	170	–	$^\circ\text{C}$
Thermal Shutdown Hysteresis	–	ΔT_{SHDN}	–	20	–	$^\circ\text{C}$

7. Limits are 100% production tested at $T_A = +25^\circ\text{C}$. Limits over the operating temperature range are guaranteed through correlation using Statistical Quality Control (SQC) Methods.

PIN DESCRIPTION

Pin Number	Symbol	Description
1	$\overline{\text{SHDN}}$	Active–Low Shutdown Input. A logic low reduces the supply current to 0.1 nA. A logic low also causes the output voltage to discharge to GND. Connect to IN for normal operation.
2	GND	Ground. This pin also functions as a heatsink. Solder to large pads or the circuit board ground plane to maximize thermal dissipation.
3	IN	Regulator Input. Supply voltage can range from +2.5 V (+2.7 V for $V_{OUT} = 1.8\text{ V}$) to +6.0 V. Bypass with 1.0 μF to GND (see <i>Capacitor Selection and Regulator Stability</i>).
4	OUT	Regulator Output. Sources up to 120 mA. Bypass with a 1.0 μF , < 1.0 Ω typical ESR capacitor to GND.
5	GND	Connect to GND.

DETAILED DESCRIPTION

The MAX8863 is a fixed output, low-dropout, low-quiescent current linear regulator designed specifically for portable, battery-operated equipment such as cellular phones, cordless phones, and modems. A 1.20 V reference, error amplifier, MOSFET driver, P-channel pass transistor, comparator, and internal feedback voltage divider comprise the MAX8863 (see Figure 3).

The bandgap reference is connected to the error amplifier's inverting input. The error amplifier then compares the reference with the selected feedback voltage and amplifies the difference. The MOSFET driver, reading the error signal, applies the correct drive to the P-channel pass transistor. If the feedback voltage is lower than the reference, the pass-transistor is pulled lower to allow more current through, and to increase the output voltage. Conversely, if the feedback voltage is higher than the reference, the pass-transistor is pulled up, which allows less current through to the output.

Turn On Response

The turn on response is defined as two separate response categories, **Wake Up Time (t_{WK})** and **Settling Time (t_s)**.

The MAX8863 has a fast Wake Up Time (10 μ sec typical) when released from shutdown. See Figure 2 for the **Wake Up Time** designated as t_{WK} . The **Wake Up Time** is defined as the time it takes for the output to rise to 2.0% of the V_{OUT} value after being released from shutdown.

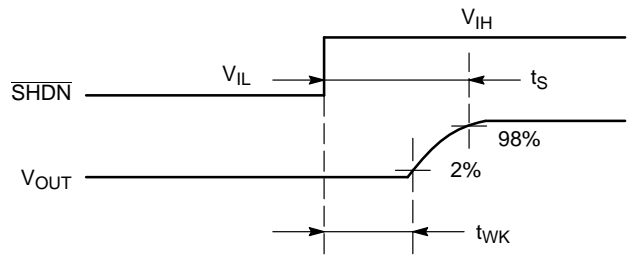

Figure 2. Wake Up Response Time

The total turn on response is defined as the **Settling Time (t_s)**, see Figure 2. **Settling Time** (inclusive with t_{WK}) is defined as the condition when the output is within 2.0% of its fully enabled value (140 μ sec typical) when released from shutdown. The settling time of the output voltage is dependent on load conditions and output capacitance on V_{OUT} (RC response).

Internal P-Channel Pass Transistor

Featuring a 1.1 Ω P-channel MOSFET pass transistor, the MAX8863 offers longer battery life than similar designs using PNP pass transistors, which waste current in dropout when the pass transistor saturates. PNP-based regulators also use high base-drive currents under large loads. The P-channel MOSFET, however, does not require a base drive current, which reduces quiescent current. The MAX8863 uses only 50 μ A of quiescent current.

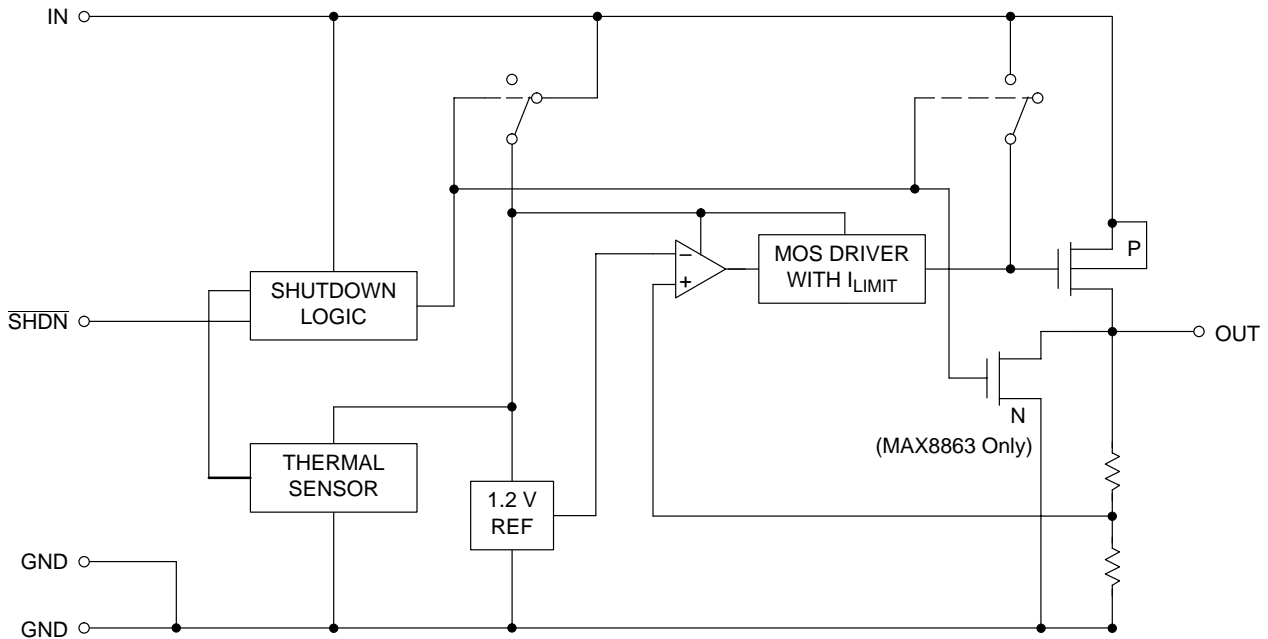

Figure 3. Functional Block Diagram

Shutdown

Low input on $\overline{\text{SHDN}}$ shuts down the MAX8863 by turning off the pass transistor, control circuit, reference, and all biases. This reduces the supply current to 0.1 nA, typical. For normal operation, connect $\overline{\text{SHDN}}$ to IN. When the MAX8863 is placed in shutdown mode, the output voltage is actively discharged to ground.

Current Limit

The current limiter on the MAX8863 monitors and controls the pass transistor's gate voltage. It estimates the output current, limiting it to 280 mA. The current limit should be considered 150 mA (min) to 410 mA (max) for design purposes. The output can be shorted to ground indefinitely without damaging the device.

Thermal Overload Protection

The MAX8863 features thermal overload protection, which limits total power dissipation. The thermal sensor signals the shutdown logic to turn off the pass transistor when the junction temperature exceeds $T_J = +170^\circ\text{C}$. This allows the IC's junction temperature to cool by 20°C before the thermal sensor turns the pass transistor back on. This results in a pulsed output during continuous thermal overload conditions.

This feature is designed to protect the MAX8863 during thermal events. High load currents and high input-output differential voltages may cause a momentary overshoot of 2.0% to 8.0% for 200 msec when the load is removed. This can be avoided by raising the minimum load current from $0\ \mu\text{A}$ ($+125^\circ\text{C}$) to $100\ \mu\text{A}$ ($+150^\circ\text{C}$). The maximum junction temperature rating of $+150^\circ\text{C}$ should not be exceeded for continuous operation.

Operating Region and Power Dissipation

The MAX8863's maximum power dissipation depends on the thermal resistance of the case and circuit board, the rate of air flow, and the temperature difference between the die junction and ambient air. The devices' power dissipation is $P = I_{\text{OUT}}(V_{\text{IN}} - V_{\text{OUT}})$; resulting maximum power dissipation is:

$$P_{\text{MAX}} = (T_J - T_A)/\Theta_{\text{JA}}$$

where $(T_J - T_A)$ is the temperature difference between the devices' die junction and the surrounding air, and Θ_{JA} is the thermal resistance of the chosen package to the surrounding air.

The devices' GND pin provides an electrical connection to ground and channels heat away. The GND pin should be connected to ground with a large pad or ground plane.

APPLICATIONS INFORMATION

Capacitor Selection and Regulator Stability

A $1.0\ \mu\text{F}$ capacitor on the input, and a $1.0\ \mu\text{F}$ capacitor on the output should generally be used on the MAX8863. For better supply-noise rejection and transient response, larger input capacitor values and lower ESR should be used. If the device is several inches from the power source or if large, fast transients are expected, a higher-value input capacitor ($10\ \mu\text{F}$) may be required.

Using large output capacitors may improve load-transient response, stability, and power-supply rejection. A minimum of $1.0\ \mu\text{F}$ is recommended for stable operation over the full temperature range with load currents up to 120 mA.

Noise

During normal operation, the MAX8863 have low ($350\ \mu\text{V}_{\text{RMS}}$) output noise. The ADC's power-supply rejection specifications should be considered for applications that include analog-to-digital converters of greater than 12 bits.

Power-Supply Rejection and Operation from Sources Other than Batteries

Power-supply rejection for the MAX8863 is 62 dB at low frequencies, rolling off above 300 Hz. Power supply noise rejection is primarily controlled by the output capacitor at frequencies of more than 20 KHz.

Supply noise rejection and transient response can be improved when operating from sources other than batteries by increasing the values of the input and output capacitors, and using passive filtering techniques.

Load Transient Considerations

With the MAX8863, typical overshoot for step changes in the load current from 0 mA to 50 mA is 12 mV. To lessen transient spikes, increase the output capacitor's value, and decrease its ESR.

Input-Output (Dropout) Voltage

A regulator's dropout voltage determines the lowest usable supply voltage. This determines the useful end-of-life battery voltage for battery-powered systems. Since the MAX8863 uses a P-channel MOSFET pass transistor, the devices' dropout voltage is a function of $R_{\text{DS(ON)}}$ multiplied by the load current.

TYPICAL CHARACTERISTICS

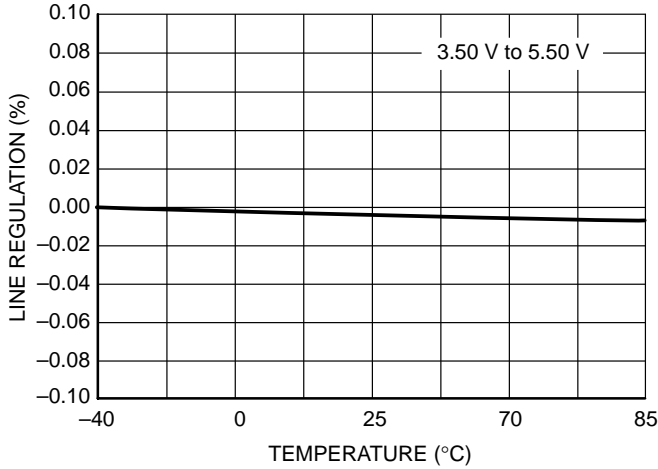

Figure 4. Line Regulation vs. Temperature

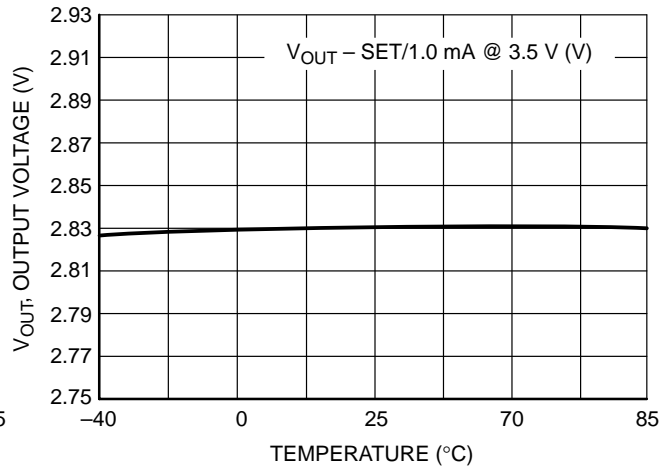

Figure 5. Output Voltage vs. Temperature

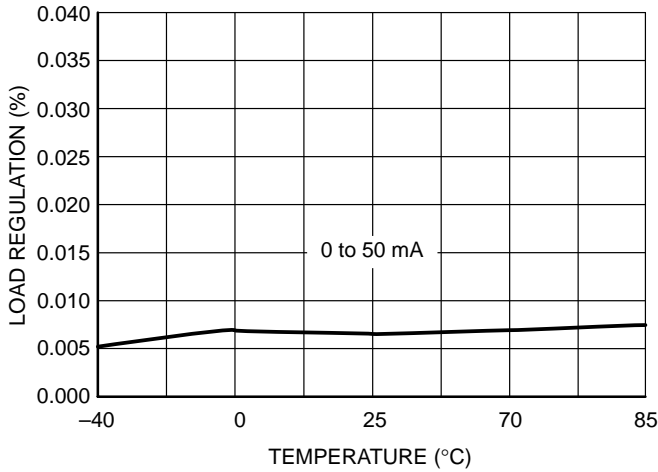

Figure 6. Load Regulation vs. Temperature

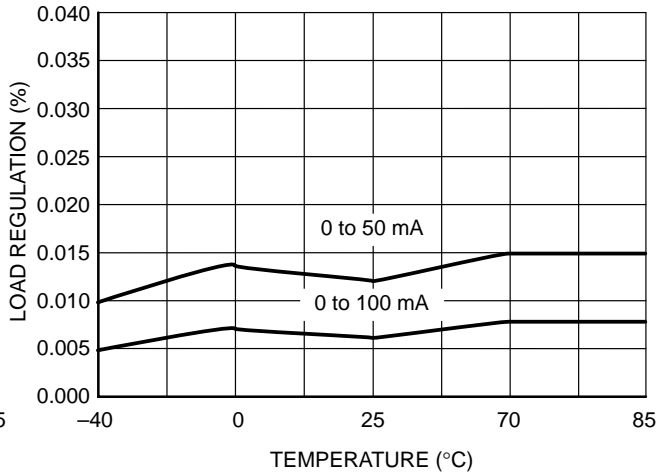

Figure 7. Load Regulation vs. Temperature

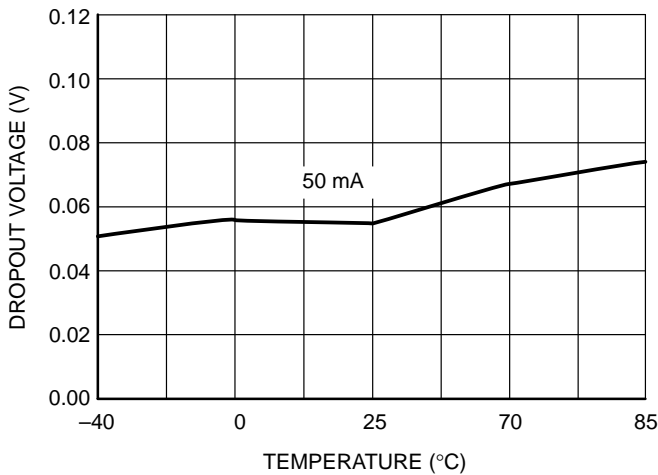

Figure 8. Dropout Voltage vs. Temperature

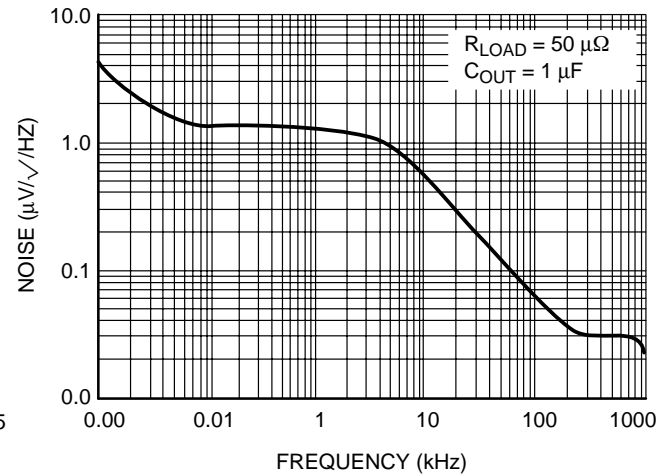

Figure 9. Output Noise vs. Frequency

TYPICAL CHARACTERISTICS

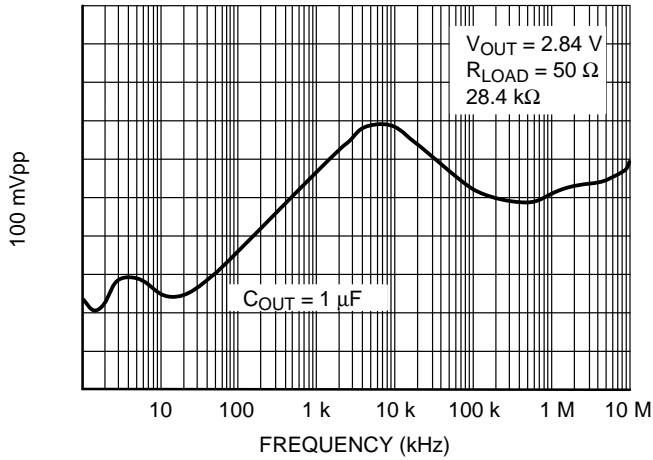

Figure 10. Power Supply Rejection Ratio

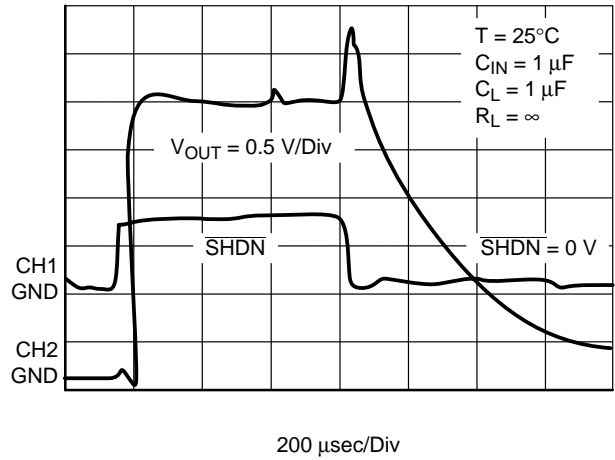

Figure 11. Shutdown Transient Response

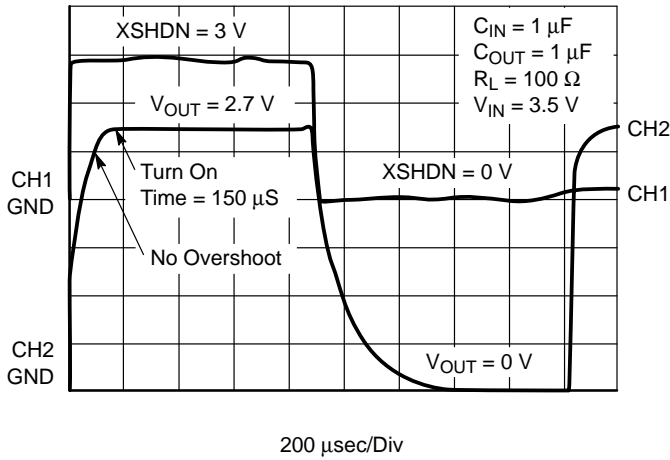

Figure 12. Shutdown Transient Response

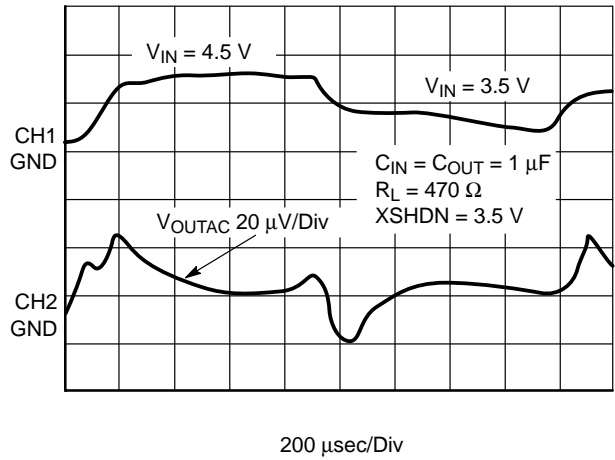

Figure 13. Line Response

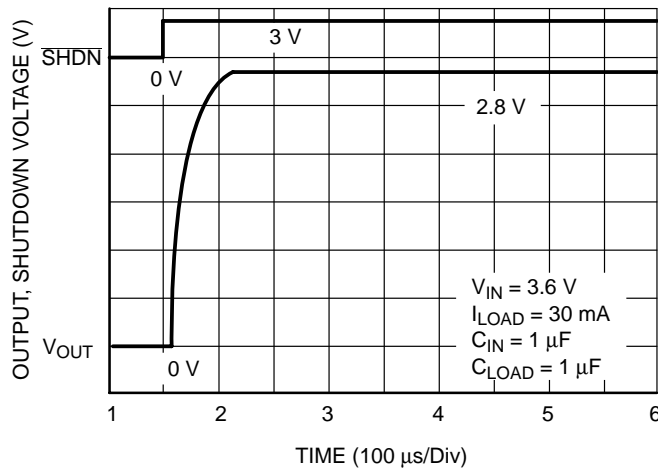
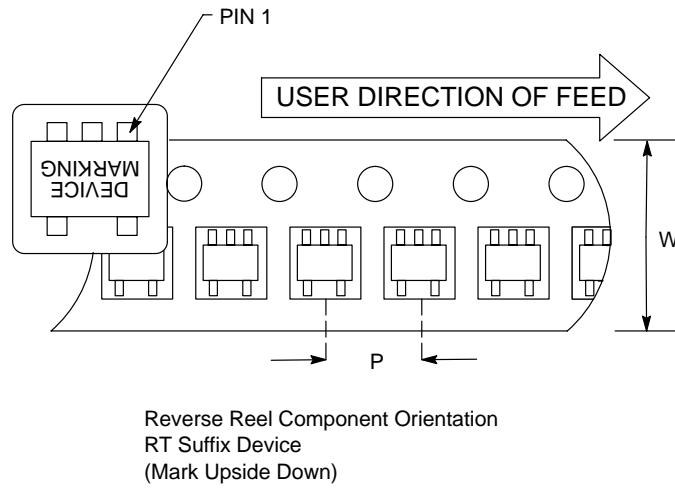
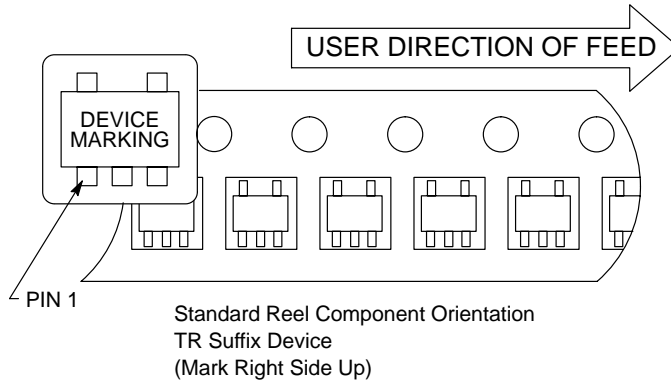

Figure 14. Wake Up Response Time

MAX8863

Component Taping Orientation for 5-Pin SOT-23 Devices



Carrier Tape, Number of Components Per Reel and Reel Size

Package	Carrier Width (W)	Pitch (P)	Part Per Full Reel	Reel Size
SOT-23	8 mm	4 mm	3000	7 inches

MAX8863

MARKING DIAGRAM

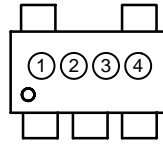

- ① and ② = Two Letter Part Number Codes
+ Temperature Range and Voltage
- ③ = Year and Quarter Code
- ④ = Lot ID Number

ORDERING INFORMATION

Device	Output Voltage*	Marking ① and ②	Package	Junction Temperature Range	Shipping
MAX8863QEUK-T	1.80	G4	SOT-23	-40°C to +85°C	3000 Tape & Reel
MAX8863REUK-T	2.80	G3			
MAX8863SEUK-T	2.84	G2			
MAX8863TEUK-T	3.15	G1			

*Other output voltages are available. Please contact ON Semiconductor for details.

MAX8863

PACKAGE DIMENSIONS

SOT-23
 EUK SUFFIX
 CASE 1212-01
 ISSUE O

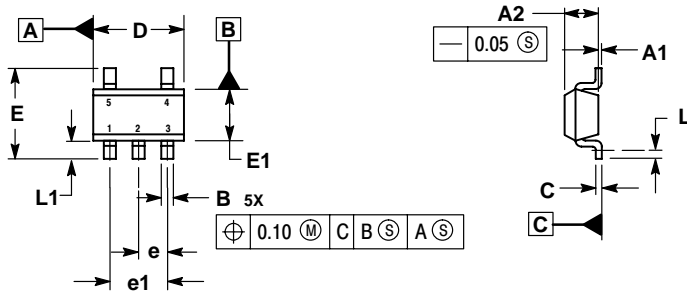

NOTES:

1. DIMENSIONS ARE IN MILLIMETERS.
2. INTERPRET DIMENSIONS AND TOLERANCES PER ASME Y14.5M, 1994.
3. DATUM C IS A SEATING PLANE.

MILLIMETERS		
DIM	MIN	MAX
A1	0.00	0.10
A2	1.00	1.30
B	0.30	0.50
C	0.10	0.25
D	2.80	3.00
E	2.50	3.10
E1	1.50	1.80
e	0.95 BSC	
e1	1.90 BSC	
L	0.20	---
L1	0.45	0.75

Notes

ON Semiconductor and  are trademarks of Semiconductor Components Industries, LLC (SCILLC). SCILLC reserves the right to make changes without further notice to any products herein. SCILLC makes no warranty, representation or guarantee regarding the suitability of its products for any particular purpose, nor does SCILLC assume any liability arising out of the application or use of any product or circuit, and specifically disclaims any and all liability, including without limitation special, consequential or incidental damages. "Typical" parameters which may be provided in SCILLC data sheets and/or specifications can and do vary in different applications and actual performance may vary over time. All operating parameters, including "Typicals" must be validated for each customer application by customer's technical experts. SCILLC does not convey any license under its patent rights nor the rights of others. SCILLC products are not designed, intended, or authorized for use as components in systems intended for surgical implant into the body, or other applications intended to support or sustain life, or for any other application in which the failure of the SCILLC product could create a situation where personal injury or death may occur. Should Buyer purchase or use SCILLC products for any such unintended or unauthorized application, Buyer shall indemnify and hold SCILLC and its officers, employees, subsidiaries, affiliates, and distributors harmless against all claims, costs, damages, and expenses, and reasonable attorney fees arising out of, directly or indirectly, any claim of personal injury or death associated with such unintended or unauthorized use, even if such claim alleges that SCILLC was negligent regarding the design or manufacture of the part. SCILLC is an Equal Opportunity/Affirmative Action Employer.

PUBLICATION ORDERING INFORMATION

NORTH AMERICA Literature Fulfillment:

Literature Distribution Center for ON Semiconductor
P.O. Box 5163, Denver, Colorado 80217 USA
Phone: 303-675-2175 or 800-344-3860 Toll Free USA/Canada
Fax: 303-675-2176 or 800-344-3867 Toll Free USA/Canada
Email: ONlit@hibbertco.com
Fax Response Line: 303-675-2167 or 800-344-3810 Toll Free USA/Canada

N. American Technical Support: 800-282-9855 Toll Free USA/Canada

EUROPE: LDC for ON Semiconductor – European Support

German Phone: (+1) 303-308-7140 (Mon-Fri 2:30pm to 7:00pm CET)
Email: ONlit-german@hibbertco.com
French Phone: (+1) 303-308-7141 (Mon-Fri 2:00pm to 7:00pm CET)
Email: ONlit-french@hibbertco.com
English Phone: (+1) 303-308-7142 (Mon-Fri 12:00pm to 5:00pm GMT)
Email: ONlit@hibbertco.com

EUROPEAN TOLL-FREE ACCESS*: 00-800-4422-3781

*Available from Germany, France, Italy, UK, Ireland

CENTRAL/SOUTH AMERICA:

Spanish Phone: 303-308-7143 (Mon-Fri 8:00am to 5:00pm MST)
Email: ONlit-spanish@hibbertco.com
Toll-Free from Mexico: Dial 01-800-288-2872 for Access –
then Dial 866-297-9322

ASIA/PACIFIC: LDC for ON Semiconductor – Asia Support

Phone: 303-675-2121 (Tue-Fri 9:00am to 1:00pm, Hong Kong Time)
Toll Free from Hong Kong & Singapore:
001-800-4422-3781
Email: ONlit-asia@hibbertco.com

JAPAN: ON Semiconductor, Japan Customer Focus Center

4-32-1 Nishi-Gotanda, Shinagawa-ku, Tokyo, Japan 141-0031
Phone: 81-3-5740-2700
Email: r14525@onsemi.com

ON Semiconductor Website: <http://onsemi.com>

For additional information, please contact your local Sales Representative.