

Click [here](#) for production status of specific part numbers.

## MAXM17574

# 4.5V to 60V, 3A High-Efficiency, DC-DC Step-Down Power Module with Integrated Inductor

### General Description

The *Himalaya* series of voltage regulator ICs and power modules enable cooler, smaller, and simpler power-supply solutions. The MAXM17574 is an easy-to-use power module that combines a synchronous step-down DC-DC converter, fully shielded inductor, and compensation components in a low-profile, thermally-efficient, system-in-package (SiP). The device operates over a wide input-voltage range of 4.5V to 60V, delivers up to 3A continuous output current, and has excellent line and load regulation over an output-voltage range of 0.9V to 15V. The device only requires five external components to complete the total power solution. The high level of integration significantly reduces design complexity, manufacturing risks, and offers a true plug-and-play power-supply solution, reducing time-to-market.

The device can be operated in pulse-width modulation (PWM) or discontinuous conduction mode (DCM).

The MAXM17574 is available in a low-profile, highly thermal-emissive, compact, 33-pin, 9mm x 15mm x 2.92mm SiP package that reduces power dissipation in the package and enhances efficiency. The feedback voltage-regulation accuracy over  $-40^{\circ}\text{C}$  to  $+125^{\circ}\text{C}$  is  $\pm 0.9\%$ . The package is easily soldered onto a printed circuit board and suitable for automated circuit board assembly.

### Applications

- Industrial Power Supplies
- Distributed Supply Regulation
- FPGA and DSP Point-of-Load Regulator
- Base Station Point-of-Load Regulator
- HVAC and Building Control

**Ordering Information** appears at end of data sheet.

### Benefits and Features

- Reduces Design Complexity, Manufacturing Risks, and Time-to-Market
  - Integrated Synchronous Step-Down DC-DC converter
  - Integrated Inductor
  - Integrated Compensation Components
- Saves Board Space in Space-Constrained Applications
  - Complete Integrated Step-Down Power Supply in a Single Package
  - Small Profile 9mm x 15mm x 2.92mm SiP Package
  - Simplified PCB Design with Minimal External BOM Components
- Offers Flexibility for Power-Design Optimization
  - Wide Input-Voltage Range from 4.5V to 60V
  - Output-Voltage Adjustable Range from 0.9V to 15V
  - Adjustable Frequency with External Frequency Synchronization (100kHz to 2.2MHz)
  - Soft-Start Programmable
  - Auxiliary bootstrap LDO for improved Efficiency
  - Optional Programmable EN/UVLO
- Operates Reliably in Adverse Industrial Environments
  - Integrated Thermal Protection
  - Hiccup Mode Overload Protection
  - RESET Output-Voltage Monitoring
  - High Industrial Ambient Operating Temperature Range ( $-40^{\circ}\text{C}$  to  $+125^{\circ}\text{C}$ ) / Junction Temperature Range ( $-40^{\circ}\text{C}$  to  $+150^{\circ}\text{C}$ )
  - Complies with CISPR22(EN55022) Class B Conducted and Radiated Emissions

### Typical Application Circuit

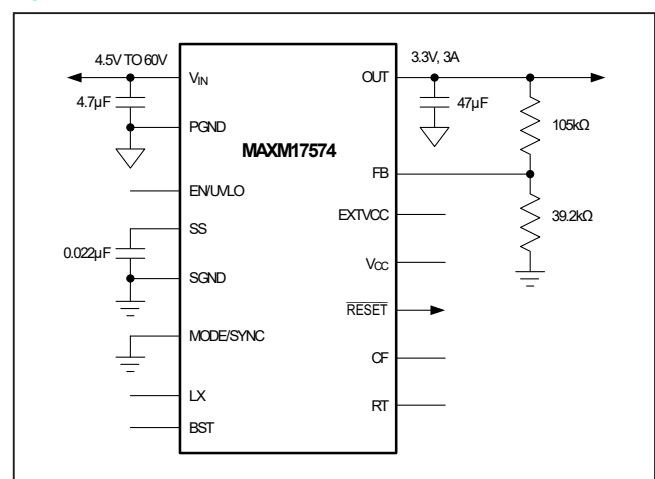

**Absolute Maximum Ratings**

V <sub>IN</sub> to PGND .....	-0.3V to +65V	$\overline{\text{RESET}}$ , SS to SGND .....	-0.3V to +6.5V
EN/UVLO to SGND .....	-0.3V to +65V	MODE/SYNC, V <sub>CC</sub> , RT, CF to SGND.....	-0.3V to +6.5V
EXTVCC to SGND .....	-0.3V to +26V	PGND to SGND.....	-0.3V to +0.3V
BST to PGND .....	-0.3V to +70V	Output Short-circuit duration .....	Continuous
BST to LX .....	-0.3V to +6.5V	Operating Temperature Range (Note 1).....	-40°C to +125°C
BST to V <sub>CC</sub> .....	-0.3V to +65V	Junction Temperature.....	+150°C
OUT to PGND (V <sub>IN</sub> < 25V).....	-0.3V to V <sub>IN</sub> + 0.3V	Storage Temperature Range .....	-65°C to +150°C
OUT to PGND (V <sub>IN</sub> > 25V).....	-0.3V to +25V	Lead Temperature (soldering, 10s) .....	+300°C
LX to PGND.....	-0.3V to V <sub>IN</sub> + 0.3V	Soldering Temperature (reflow) .....	+260°C
FB to SGND .....	-0.3V to +1.5V		

Stresses beyond those listed under "Absolute Maximum Ratings" may cause permanent damage to the device. These are stress ratings only, and functional operation of the device at these or any other conditions beyond those indicated in the operational sections of the specifications is not implied. Exposure to absolute maximum rating conditions for extended periods may affect device reliability.

**Package Information**

<b>PACKAGE TYPE: 33-PIN SiP</b>	
Package Code	L33915#3
Outline Number	<a href="#">21-100175</a>
Land Pattern Number	<a href="#">90-100057</a>
<b>THERMAL RESISTANCE, FOUR-LAYER BOARD (Note 2)</b>	
Junction to Ambient Thermal Resistance ( $\theta_{JA}$ )	22.6°C/W

For the latest package outline information and land patterns (footprints), go to [www.maximintegrated.com/packages](http://www.maximintegrated.com/packages). Note that a "+", "#", or "-" in the package code indicates RoHS status only. Package drawings may show a different suffix character, but the drawing pertains to the package regardless of RoHS status.

- Note 1:** Junction temperature greater than +125°C degrades operating lifetimes.
- Note 2:** Package thermal resistance is measured on evaluation board with natural convection.

## Electrical Characteristics

( $V_{IN} = V_{EN/UVLO} = 24V$ ,  $R_{RT} = 40.2k\Omega$  ( $f_{SW} = 500kHz$ ),  $V_{SGND} = V_{PGND} = V_{MODE/SYNC} = V_{EXTVCC} = 0V$ ,  $V_{FB} = 1V$ ,  $SS = CF = \overline{RESET} = LX = OUT = BST = V_{CC} = OPEN$ ,  $T_A = -40^\circ C$  to  $125^\circ C$ , unless otherwise noted. Typical values are at  $T_A = +25^\circ C$ . All voltages are referenced to SGND, unless otherwise noted.) (Note 3)

PARAMETER	SYMBOL	CONDITIONS	MIN	TYP	MAX	UNITS
<b>INPUT SUPPLY (<math>V_{IN}</math>)</b>						
Input Voltage Range	$V_{IN}$		4.5		60	V
Input Shutdown Current	$I_{IN-SH}$	$V_{EN/UVLO} = 0V$ , shutdown mode		10	15	$\mu A$
Input Quiescent Current	$I_{Q\_DCM}$	DCM Mode, $V_{LX} = 0.1V$		1.2	1.8	mA
	$I_{Q\_PWM}$	Normal Switching Mode, $f_{SW} = 650kHz$ , $V_{OUT} = EXT V_{CC} = 5V$		12.5		
<b>ENABLE/UVLO (EN)</b>						
EN/UVLO Threshold	$V_{ENR}$	$V_{EN/UVLO}$ rising	1.19	1.215	1.26	V
	$V_{ENF}$	$V_{EN/UVLO}$ falling	1.068	1.09	1.131	
	$V_{EN-TRUESD}$	$V_{EN/UVLO}$ falling, true shutdown		0.8		
Enable Pullup resistor	$R_{ENP}$	Pullup resistor between IN and EN/UVLO pins	3.15	3.3	3.45	M $\Omega$
<b>LDO (<math>V_{CC}</math>)</b>						
$V_{CC}$ Output-Voltage Range	$V_{CC}$	$1mA < I_{VCC} < 25mA$	4.75	5	5.25	V
		$6V \leq V_{IN} \leq 60V$ ; $I_{VCC} = 1mA$	4.75	5	5.25	
$V_{CC}$ Current Limit	$I_{VCC(MAX)}$	$V_{CC} = 4.3V$ , $V_{IN} = 7V$	40	65	130	mA
$V_{CC}$ Dropout	$V_{CC(DO)}$	$V_{IN} = 4.5V$ , $I_{VCC} = 20mA$			0.3	V
$V_{CC}$ UVLO	$V_{CC(UVR)}$	Rising	4.05	4.2	4.3	V
	$V_{CC(UVF)}$	Falling	3.65	3.8	3.9	
<b>EXT LDO (EXTVCC)</b>						
EXTVCC Operating Voltage Range			4.84		24	V
EXTVCC Switchover Threshold		EXTVCC rising	4.55	4.7	4.84	V
		EXTVCC falling	4.3	4.48	4.6	
EXTVCC Dropout	EXTVCC(DO)	EXTVCC = 4.85V, $I_{VCC} = 20mA$			0.4	V
EXTVCC Current Limit	$I_{VCC(MAX)}$	$V_{CC} = 4.5V$ , EXTVCC = 8V	40	80	150	mA
<b>SOFT-START (SS)</b>						
Charging Current	$I_{SS}$	$V_{SS} = 0.5V$	4.7	5	5.3	$\mu A$
<b>OUTPUT SPECIFICATION</b>						
Line-Regulation Accuracy		$V_{IN} = 10V$ to $60V$ , $V_{OUT} = 5V$		0.1		mV/V
Load-Regulation Accuracy		$I_{OUT} = 0A$ to $1.5A$		1		mV/A
FB Regulation Voltage	$V_{FB\_REG}$	MODE/SYNC = SGND or $V_{CC}$	0.892	0.9	0.908	V
FB Input Leakage Current	$I_{FB}$	$V_{FB} = 1V$ , $T_A = 25^\circ C$	-50		50	nA
$V_{FB}$ Undervoltage Trip Level to Cause HICCUP	$V_{OUT(HICF)}$		0.56	0.58	0.65	V
HICCUP Timeout				32768		Cycles

**Electrical Characteristics (continued)**

( $V_{IN} = V_{EN}/UVLO = 24V$ ,  $R_{RT} = 40.2k\Omega$  ( $f_{SW} = 500kHz$ ),  $V_{SGND} = V_{PGND} = V_{MODE/SYNC} = V_{EXTVCC} = 0V$ ,  $V_{FB} = 1V$ ,  $SS = CF = \overline{RESET} = LX = OUT = BST = V_{CC} = OPEN$ ,  $T_A = -40^\circ C$  to  $125^\circ C$ , unless otherwise noted. Typical values are at  $T_A = +25^\circ C$ . All voltages are referenced to SGND, unless otherwise noted.) (Note 3)

PARAMETER	SYMBOL	CONDITIONS	MIN	TYP	MAX	UNITS
<b>MODE/SYNC</b>						
MODE Threshold	$V_{M(DCM)}$	MODE/SYNC = $V_{CC}$ (DCM Mode)	$V_{CC} - 0.65$			V
	$V_{M(PWM)}$	MODE/SYNC = SGND (PWM Mode)	0.75			
SYNC Frequency Capture Range			1.1 x $f_{SW}$		1.4 x $f_{SW}$	kHz
SYNC Pulse Width			50			ns
SYNC Threshold	$V_{IH}$		2.1			V
	$V_{IL}$		0.8			
<b>RT</b>						
Switching Frequency	$f_{SW}$	$R_{RT} = OPEN$	460	500	540	kHz
		$R_{RT} = 40.2k$	475	500	525	
		$R_{RT} = 8.06K$	1950	2200	2450	
		$R_{RT} = 210K$	90	100	110	
Minimum On-Time	$t_{ON(MIN)}$		60		80	ns
Minimum Off-Time	$t_{OFF(MIN)}$		140		160	ns
<b>RESET</b>						
$\overline{RESET}$ Output Level Low		$I_{RESET} = 10mA$		0.4		V
$\overline{RESET}$ Output leakage Current		$T_A = T_J = +25^\circ C$ , $V_{RESET} = 5.5V$	-0.1		0.1	$\mu A$
FB Threshold for $\overline{RESET}$ Deassertion	$V_{FB-OKR}$	$V_{FB}$ rising	93.8	95	97.8	%
FB Threshold for $\overline{RESET}$ Assertion	$V_{FB-OKF}$	$V_{FB}$ falling	90.5	92	94.6	%
$\overline{RESET}$ Deassertion Delay After FB Reaches 95% Regulation			1024			Cycles
<b>THERMAL SHUTDOWN (TEMP)</b>						
Thermal Shutdown Threshold		Temperature rising	165			$^\circ C$
Thermal Shutdown Hysteresis			10			$^\circ C$

**Note 3:** Electrical specifications are production tested at  $T_A = +25^\circ C$ . Specifications over the entire operating temperature range are guaranteed by design and characterization.

Typical Operating Characteristics

( $V_{IN} = V_{EN}/UVLO = 24V$ ,  $V_{GND} = V_{PGND} = 0V$ ,  $T_A = -40^{\circ}C$  to  $+125^{\circ}C$ , unless otherwise noted. Typical values are at  $T_A = +25^{\circ}C$ . All voltages are referenced to GND, unless otherwise noted. The circuit values for different output voltage applications are as in Table 1, unless otherwise noted.)

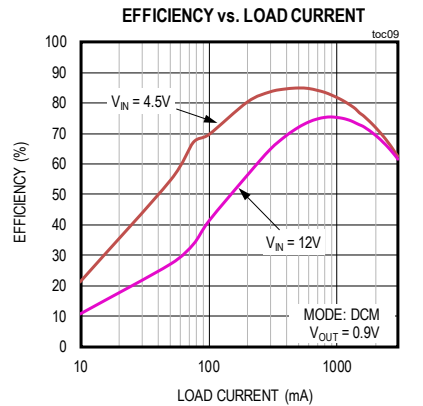
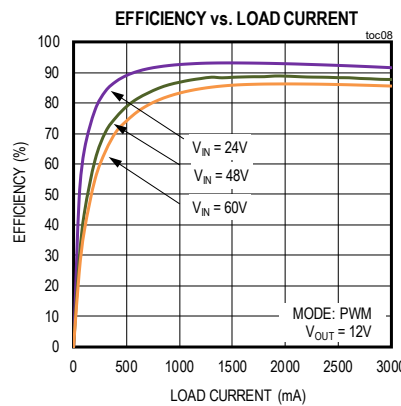
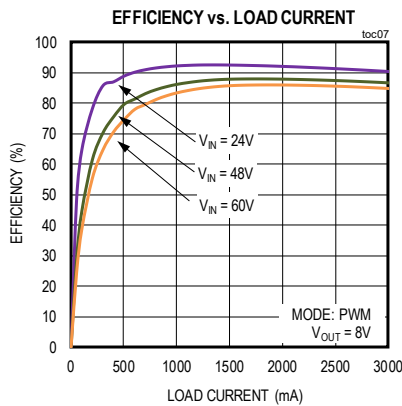
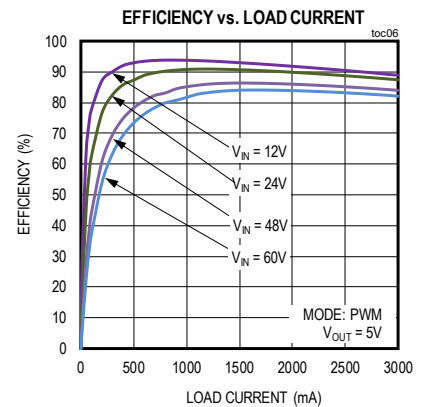
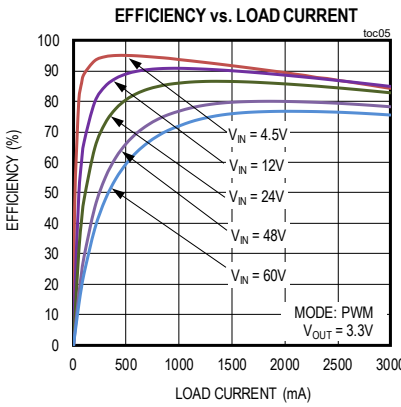
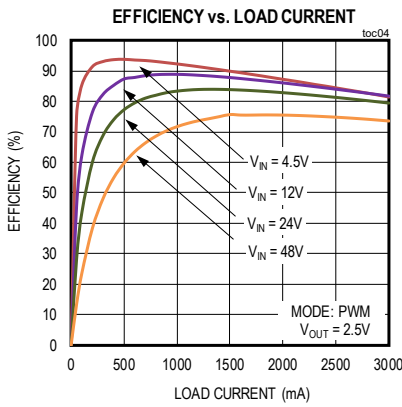
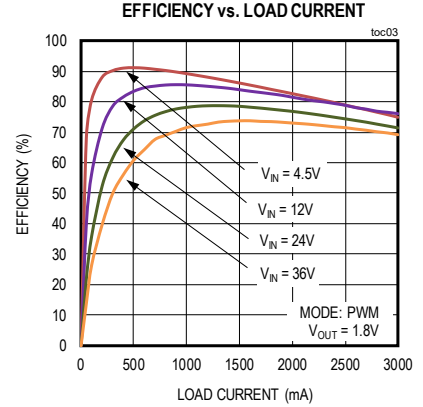
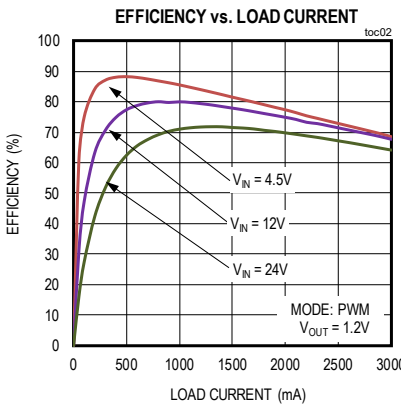
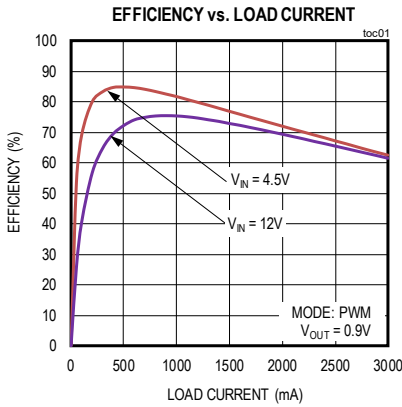

Typical Operating Characteristics (continued)

( $V_{IN} = V_{EN}/UVLO = 24V$ ,  $V_{GND} = V_{PGND} = 0V$ ,  $T_A = -40^{\circ}C$  to  $+125^{\circ}C$ , unless otherwise noted. Typical values are at  $T_A = +25^{\circ}C$ . All voltages are referenced to GND, unless otherwise noted. The circuit values for different output voltage applications are as in [Table 1](#), unless otherwise noted.)

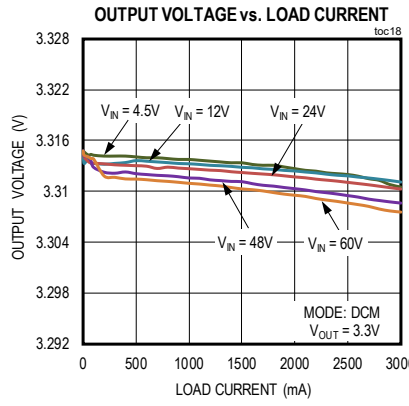
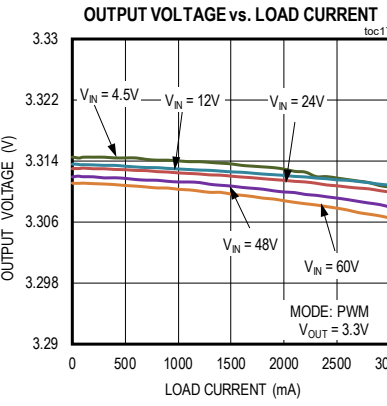
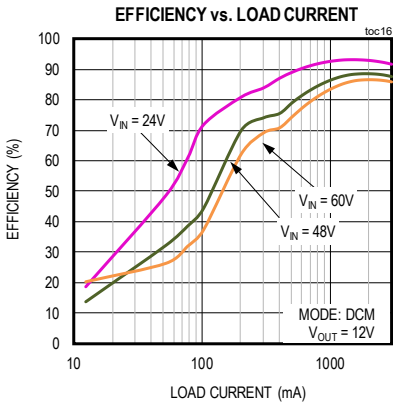
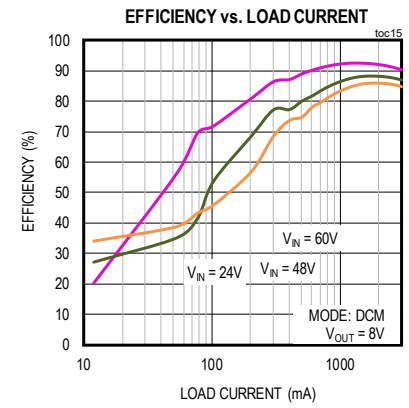
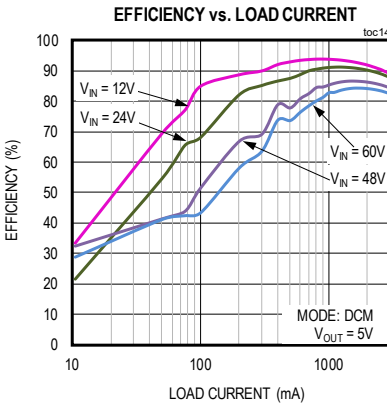
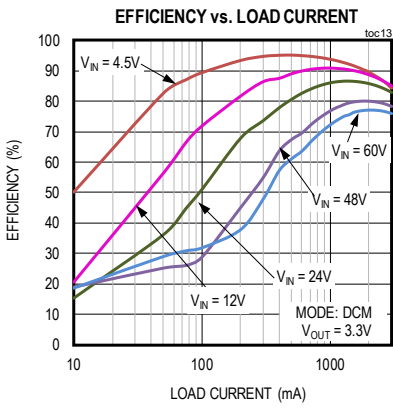
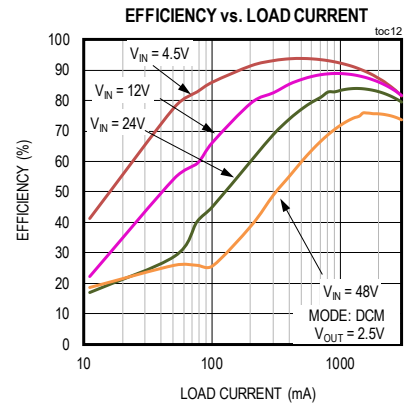
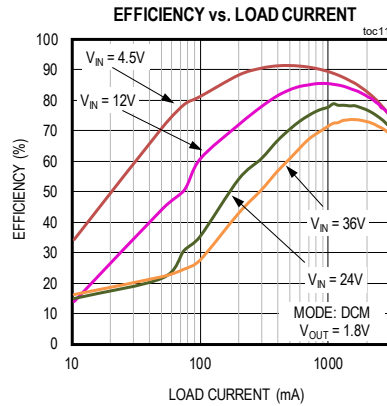
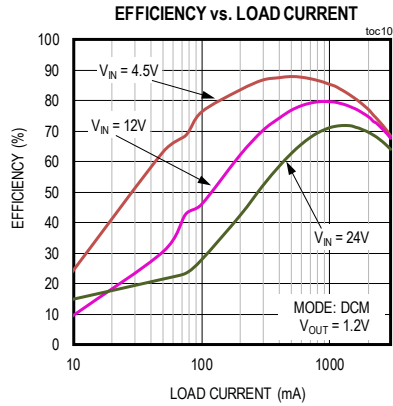

Typical Operating Characteristics (continued)

( $V_{IN} = V_{EN}/UVLO = 24V$ ,  $V_{GND} = V_{PGND} = 0V$ ,  $T_A = -40^{\circ}C$  to  $+125^{\circ}C$ , unless otherwise noted. Typical values are at  $T_A = +25^{\circ}C$ . All voltages are referenced to GND, unless otherwise noted. The circuit values for different output voltage applications are as in Table 1, unless otherwise noted.)

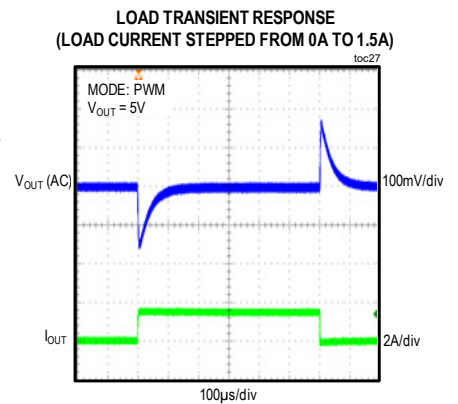
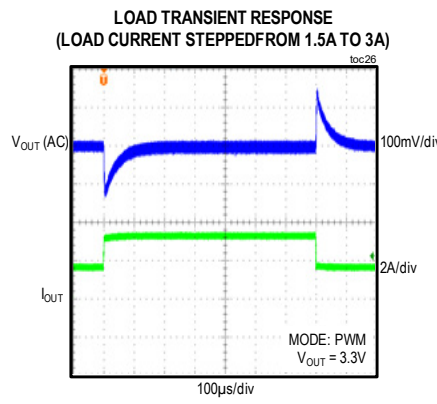
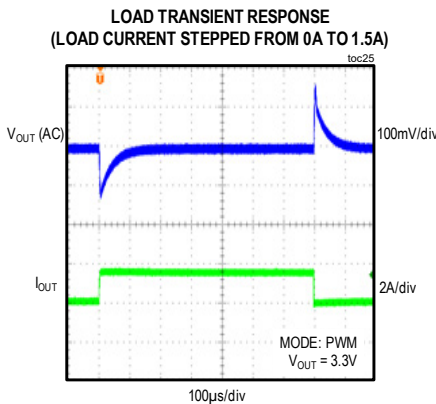
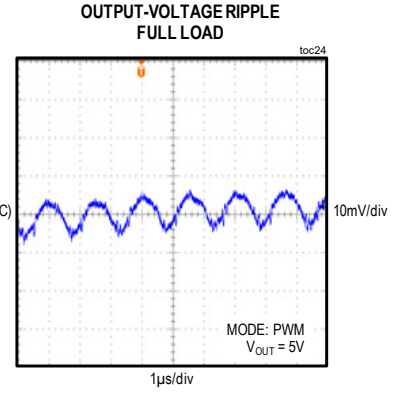
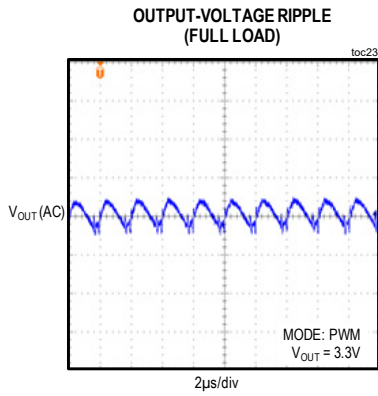
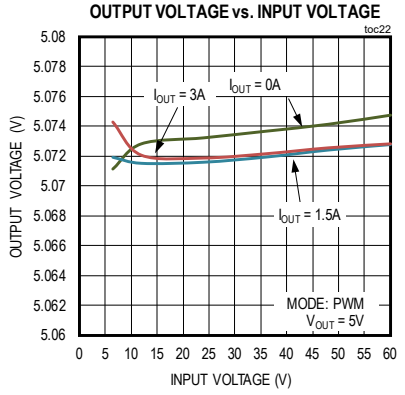
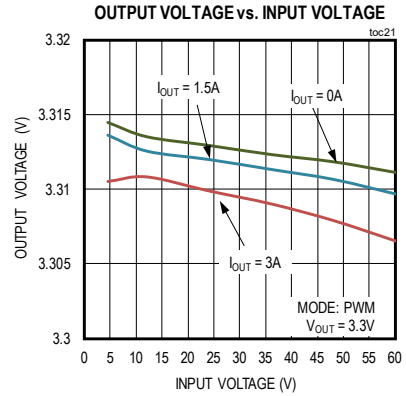
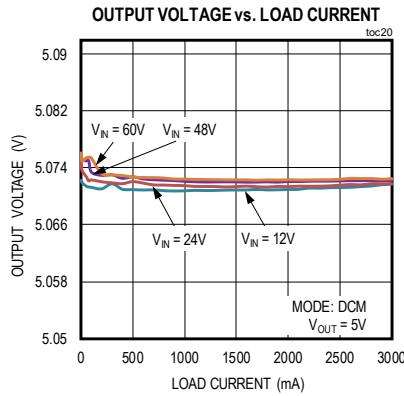
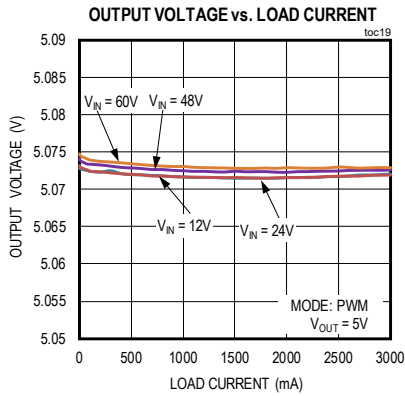

Typical Operating Characteristics (continued)

( $V_{IN} = V_{EN/UVLO} = 24V$ ,  $V_{GND} = V_{PGND} = 0V$ ,  $T_A = -40^{\circ}C$  to  $+125^{\circ}C$ , unless otherwise noted. Typical values are at  $T_A = +25^{\circ}C$ . All voltages are referenced to GND, unless otherwise noted. The circuit values for different output voltage applications are as in [Table 1](#), unless otherwise noted.)

LOAD TRANSIENT RESPONSE  
(LOAD CURRENT STEPPED FROM 1.5A TO 3A)

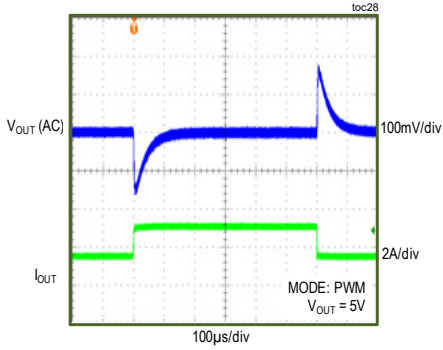

LOAD TRANSIENT RESPONSE  
(LOAD CURRENT STEPPED FROM 50mA TO 1.5A)

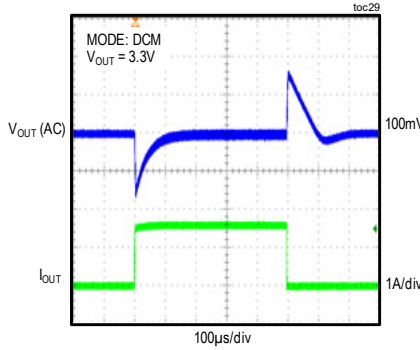

LOAD TRANSIENT RESPONSE  
(LOAD CURRENT STEPPED FROM 50mA TO 1.5A)

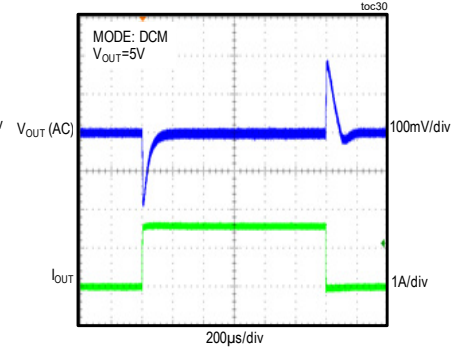

STARTUP THROUGH ENABLE  
(LOAD RESISTANCE = 1.1Ω)

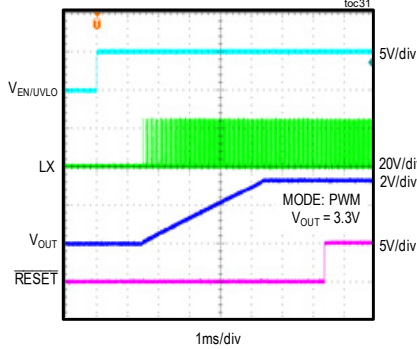

STEADY-STATE SWITCHING WAVEFORMS

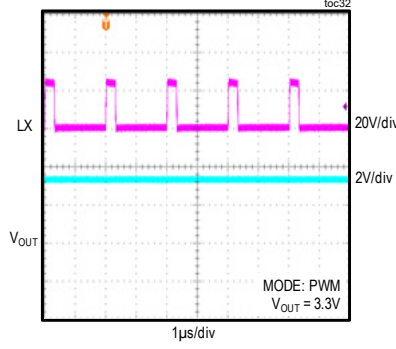

SHUTDOWN THROUGH ENABLE  
(LOAD RESISTANCE = 1.1Ω)

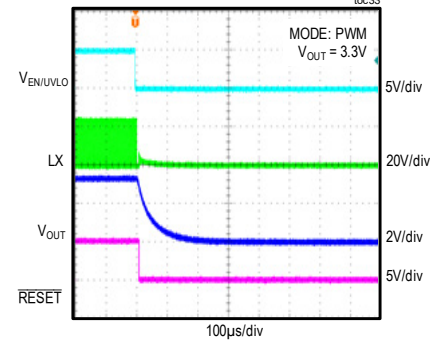

STARTUP THROUGH ENABLE  
(LOAD RESISTANCE = 1.67Ω)

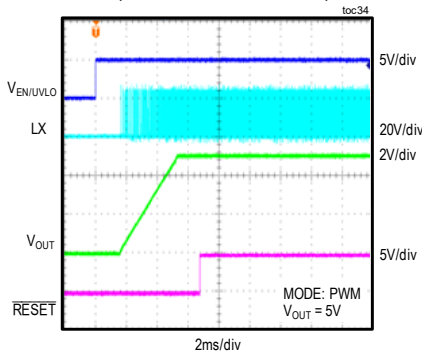

STEADY-STATE SWITCHING WAVEFORMS

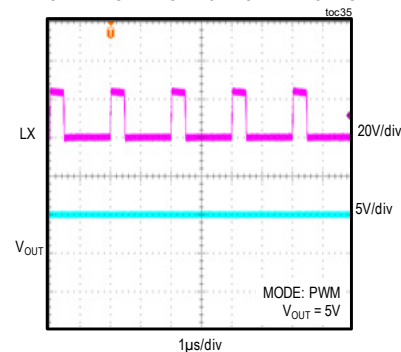



Typical Operating Characteristics (continued)

( $V_{IN} = V_{EN/UVLO} = 24V$ ,  $V_{GND} = V_{PGND} = 0V$ ,  $T_A = -40^{\circ}C$  to  $+125^{\circ}C$ , unless otherwise noted. Typical values are at  $T_A = +25^{\circ}C$ . All voltages are referenced to GND, unless otherwise noted. The circuit values for different output voltage applications are as in [Table 1](#), unless otherwise noted.)

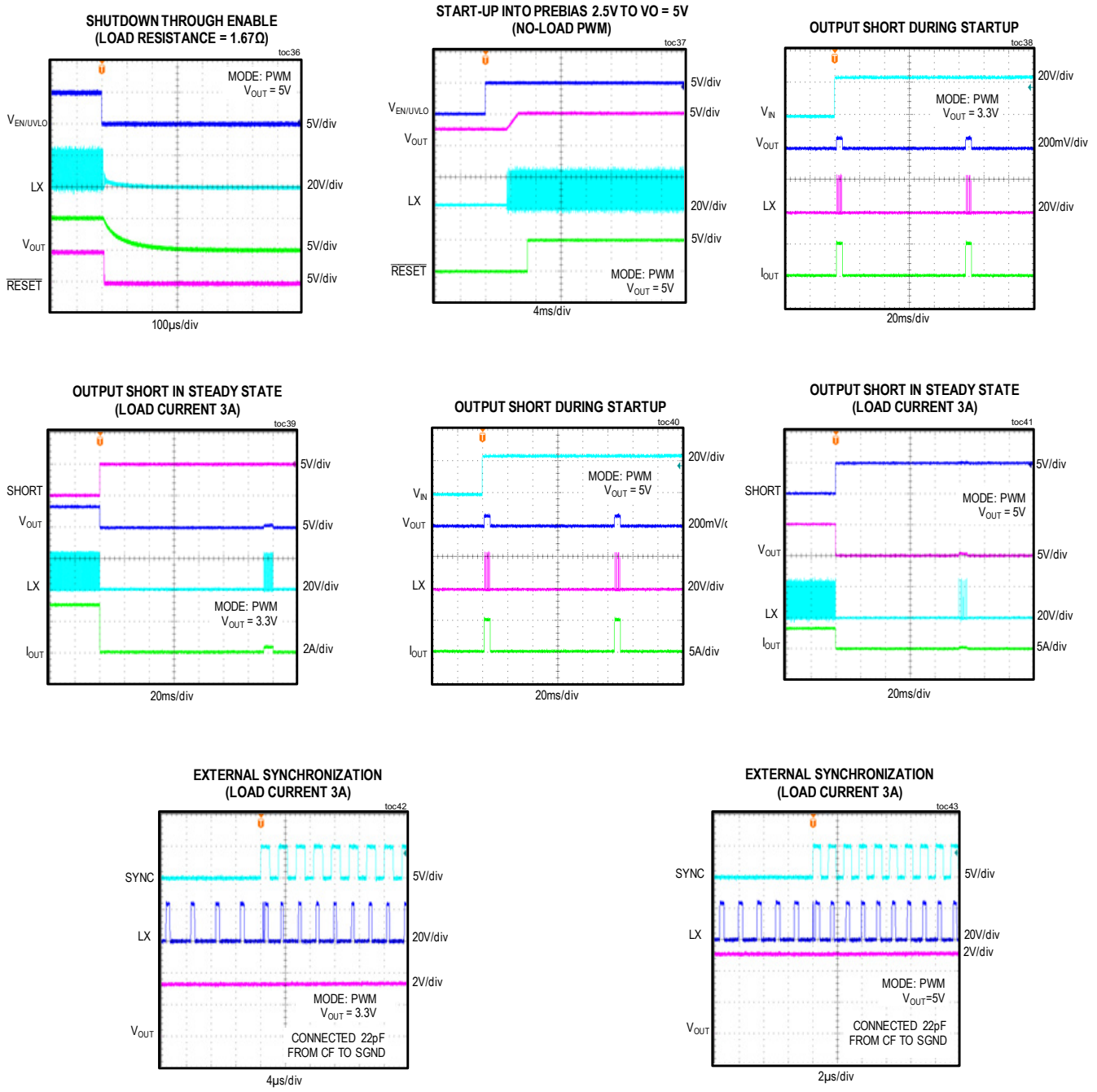

Typical Operating Characteristics (continued)

( $V_{IN} = V_{EN}/UVLO = 24V$ ,  $V_{GND} = V_{PGND} = 0V$ ,  $T_A = -40^{\circ}C$  to  $+125^{\circ}C$ , unless otherwise noted. Typical values are at  $T_A = +25^{\circ}C$ . All voltages are referenced to GND, unless otherwise noted. The circuit values for different output voltage applications are as in [Table 1](#), unless otherwise noted.)

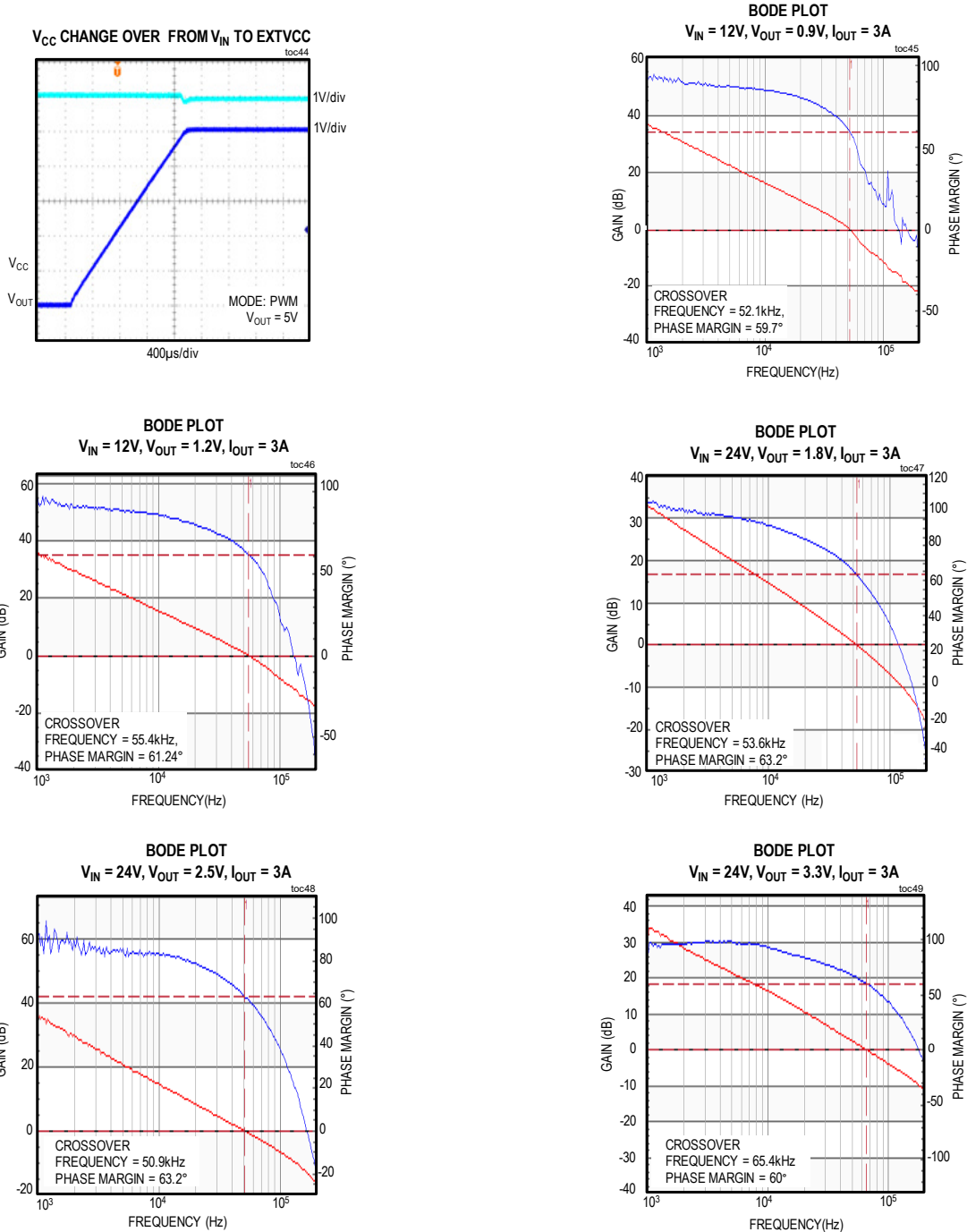

Typical Operating Characteristics (continued)

( $V_{IN} = V_{EN}/UVLO = 24V$ ,  $V_{GND} = V_{PGND} = 0V$ ,  $T_A = -40^{\circ}C$  to  $+125^{\circ}C$ , unless otherwise noted. Typical values are at  $T_A = +25^{\circ}C$ . All voltages are referenced to GND, unless otherwise noted. The circuit values for different output voltage applications are as in Table 1, unless otherwise noted.)

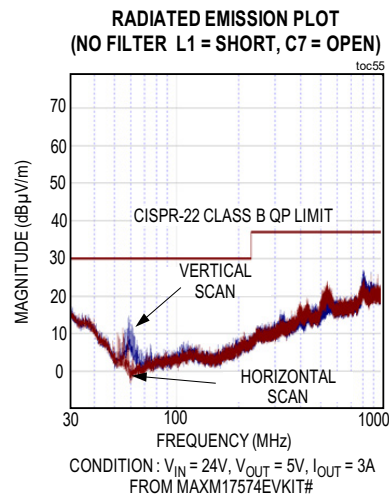
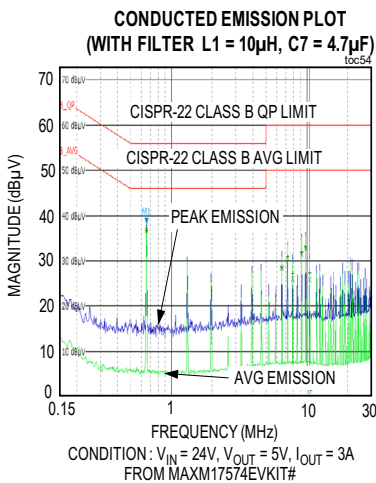
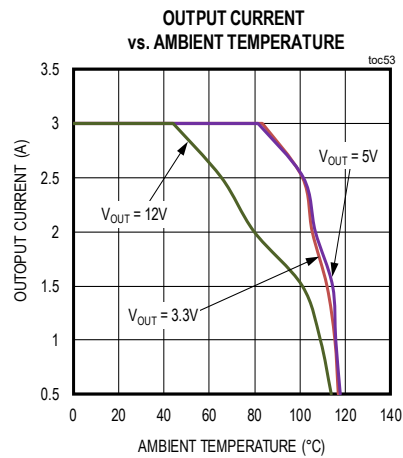
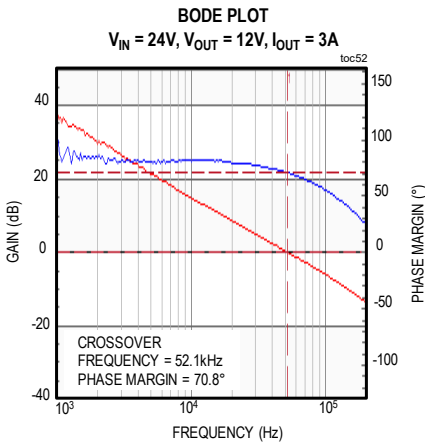
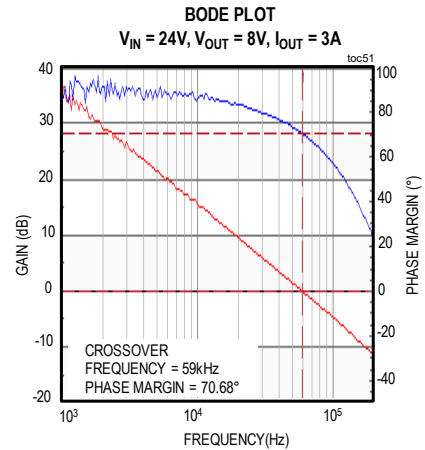
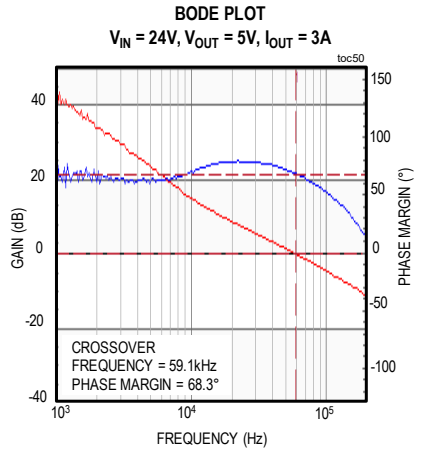

Pin Configuration

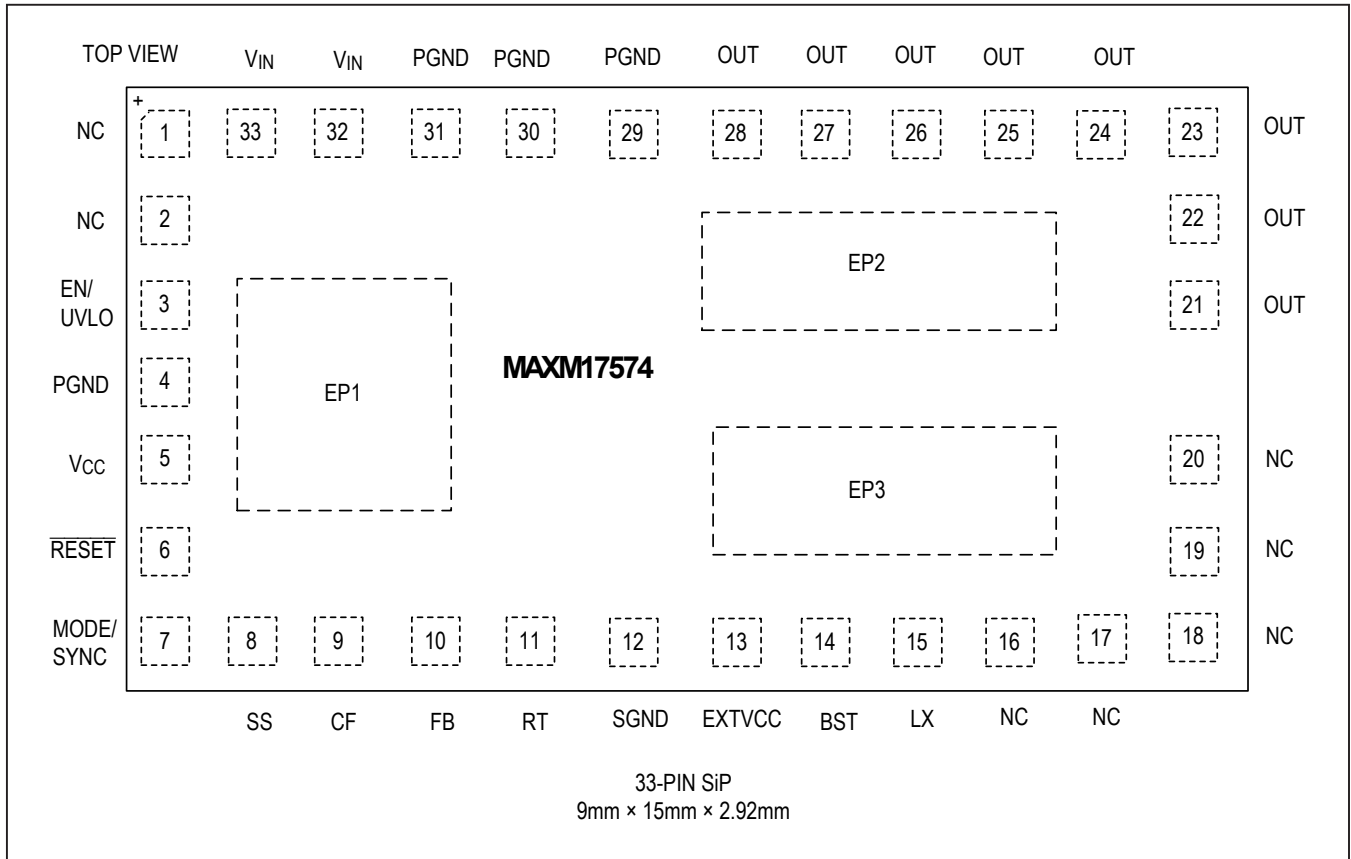

## Pin Description

PIN	NAME	FUNCTION
1, 2, 16-20, EP3	NC	Not connected
3	EN/UVLO	Enable/Undervoltage-Lockout Input. Connect a resistor from EN/UVLO to SGND to set the UVLO threshold. See the <i>Input Undervoltage-Lockout Level</i> section for more details.
4, 29-31	PGND	Power Ground. Connect the PGND pins to the power ground plane.
5	V <sub>CC</sub>	5V LDO Output. The V <sub>CC</sub> is bypassed to PGND internally through a 2.2μF capacitor. Do not connect any external components to the V <sub>CC</sub> pin.
6	$\overline{\text{RESET}}$	Open-Drain $\overline{\text{RESET}}$ Output. The $\overline{\text{RESET}}$ output is driven low if FB drops below 92% of its set value. $\overline{\text{RESET}}$ goes high 1024 clock cycles after FB rises above 95% of its set value.
7	MODE/SYNC	Configures Device Mode of Operation. MODE pin configures the device to operate either in PWM or DCM modes of operation. Connect MODE to SGND for constant-frequency PWM operation at all loads. Connect MODE to V <sub>CC</sub> for DCM operation. The device can be synchronized to an external clock using this pin. See the <i>Mode Selection (MODE)</i> section and the <i>External Frequency Synchronization</i> section for more details.
8	SS	Soft-Start Input. Connect a capacitor from SS to SGND to set the soft-start time.
9	CF	Compensation Pin. Connect a capacitor from CF to FB when the switching frequency is below 500kHz. Leave CF open for switching frequency greater than 500kHz. See the <i>Loop Compensation</i> section for more details.
10	FB	Feedback Input. Connect FB to the center tap of an external resistor-divider from the output to SGND to set the output voltage. See the <i>Adjusting Output Voltage</i> section for more details.
11	RT	Pin for Programming Switching Frequency. Connect a resistor from RT to SGND to set the regulator's switching frequency between 100kHz and 2.2MHz. Leave RT open for the default 500kHz frequency. See the <i>Setting the Switching Frequency</i> section for more details.
12	SGND	Analog Ground pin.
13	EXTVCC	External Power Supply Input for the Internal LDO. Applying a voltage between 4.84V and 24V at EXTVCC pin bypasses the internal LDO and improves the efficiency.
14	BST	Boost Flying Capacitor. Internally a 0.1μF is connected from BST to LX. Do not connect any external components to BST pin.
15	LX	Switching Node. Do not connect any external components to the LX pin.
21-28	OUT	Regulator Output Pin. Connect required capacitor from OUT to PGND.
32-33	V <sub>IN</sub>	Power-Supply Input. Connect the V <sub>IN</sub> pins together. Decouple to PGND with a capacitor. Place the capacitor close to the V <sub>IN</sub> and PGND pins.
EP1	SGND	Exposed Pad. Connect to the SGND of the Module. Connect to a large copper plane below the IC to improve heat dissipation capability.
EP2	OUT	Exposed Pad. Connect this pad to the OUT pin of the Module. Connect to a large copper plane below the Module to improve heat dissipation capability.

Functional Diagram

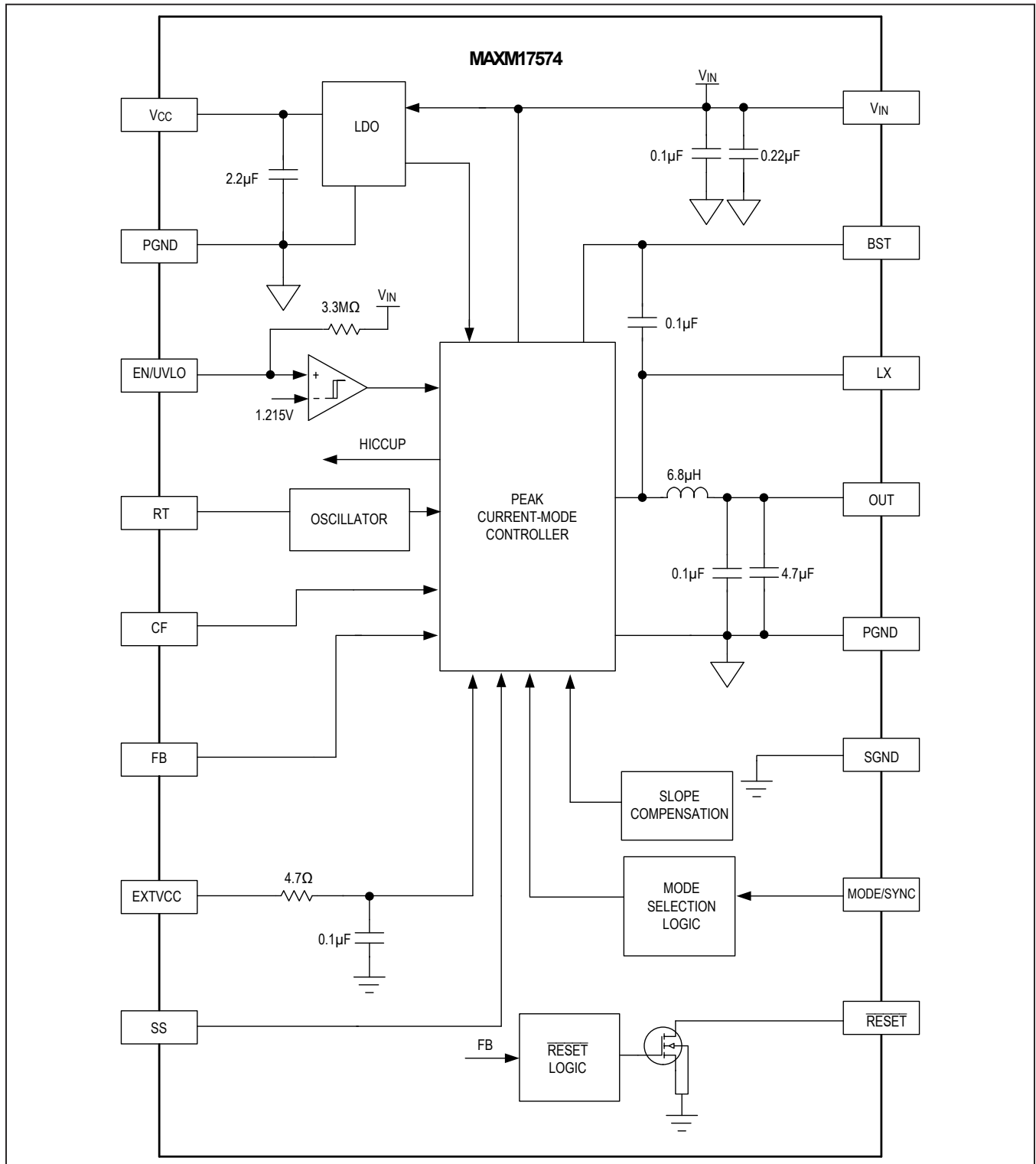

## Detailed Description

The MAXM17574 is a high-efficiency, high-voltage step-down power module with dual-integrated MOSFETs that operates over a 4.5V to 60V input and supports a programmable output voltage from 0.9V to 15V, delivering up to 3A current. The module integrates all the necessary components required for the switching converter. Built-in compensation for the entire output-voltage range eliminates the need for external components.

The device features a peak-current-mode control architecture with a MODE feature that can be used to operate the device in pulse-width modulation (PWM) or discontinuous-conduction mode (DCM) control schemes. PWM operation provides constant frequency operation at all loads, and is useful in applications sensitive to switching frequency. DCM features constant frequency operation and disables negative inductor currents at light loads. DCM operation offers higher efficiency at light loads than PWM mode.

A programmable soft-start feature allows users to reduce input inrush current. The device also incorporates an output enable/undervoltage-lockout pin (EN/UVLO) that allows the user to turn on the part at the desired input-voltage level. An open-drain  $\overline{\text{RESET}}$  pin provides a delayed power-good signal to the system upon achieving successful regulation of the output voltage.

### Mode Selection (MODE)

The logic state of the MODE pin is latched when  $V_{CC}$  and EN/UVLO voltages exceed the respective UVLO rising thresholds and all internal voltages are ready to allow LX switching. If the MODE pin is grounded during power-up, the device operates in constant frequency PWM mode at all loads. If the MODE pin is connected to  $V_{CC}$  during power-up, the device operates in constant frequency DCM mode at light loads. State changes on the MODE pin are ignored during normal operation.

### Modes of Operation

PWM operation provides constant frequency operation at all loads, and is useful in applications sensitive to variable switching frequency. In PWM mode, the inductor current is allowed to go negative. DCM mode of operation doesn't allow the inductor current to go negative. Because of this, the PWM mode of operation gives lower efficiency at light loads compared to DCM mode of operation.

### Setting the Switching Frequency

The switching frequency of the device can be programmed from 100kHz to 2.2MHz by using a resistor connected from the RT pin to SGND. The switching frequency ( $f_{SW}$ ) is related to the resistor ( $R_{RT}$ ) connected between RT and SGND pins by the following equation:

$$R_{RT} = \frac{21 \times 10^3}{f_{SW}} - 1.7$$

where  $R_{RT}$  is in k $\Omega$  and  $f_{SW}$  is in kHz. Leaving the RT pin open causes the device to operate at the default switching frequency of 500kHz.

### External Frequency Synchronization

The internal oscillator of the MAXM17574 can be synchronized to an external clock signal on the MODE/SYNC pin. The external synchronization clock frequency must be between  $1.1 \times f_{SW}$  and  $1.4 \times f_{SW}$ , where  $f_{SW}$  is the frequency programmed by the  $R_{RT}$  resistor. When an external clock is applied to MODE/SYNC pin, the internal oscillator frequency changes to external clock frequency (from original frequency based on RT setting) after detecting 16 external clock edges. The converter operates in PWM mode during synchronization operation. When the external clock is applied on-fly then the mode of operation changes to PWM from the initial state of DCM/PWM. When the external clock is removed on-fly then the internal oscillator frequency changes to the RT set frequency and the converter still continues to operate in PWM mode until either power cycling or enable cycling. For applications that need external clock synchronization, a 22pF capacitor should be connected from the CF to the SGND pin for robust operation. The minimum external clock pulse-width high should be greater than 50ns. See the MODE/SYNC section in the [Electrical Characteristics](#) table for details.

### Linear Regulator ( $V_{CC}$ and EXT $V_{CC}$ )

The MAXM17574 has two internal low-dropout (LDO) regulators that powers  $V_{CC}$ . During power-up, when the EN/UVLO pin voltage is above the true shutdown voltage, then the  $V_{CC}$  is powered from INLDO. When  $V_{CC}$  voltage is above the  $V_{CC}$  UVLO threshold and EXT $V_{CC}$  voltage is greater than 4.7V the  $V_{CC}$  is powered from EXT $V_{CC}$  LDO. Only one of the two LDOs is in operation at a time, depending on the voltage levels present at EXT $V_{CC}$ . Powering  $V_{CC}$  from EXT $V_{CC}$  increases efficiency at higher input voltages. EXT $V_{CC}$  voltage should not exceed 24V.

Typical  $V_{CC}$  output voltage is 5V. Internally,  $V_{CC}$  is bypassed with a 2.2 $\mu$ F ceramic capacitor to PGND. See the [Electrical Characteristics](#) table for the current limit details for both the regulators. In applications where the buck converter output is connected to the EXT $V_{CC}$  pin, if the output is shorted to ground, then the transfer from EXT $V_{CC}$  LDO to INLDO happens seamlessly without any impact on the normal functionality.

### Input-Voltage Range

The minimum and maximum operating input voltages for a given output voltage should be calculated as follows:

$$V_{IN(MIN)} = \frac{V_{OUT} + (I_{OUT} \times 0.195)}{1 - (f_{SW(MAX)} \times t_{OFF(MAX)})} + (I_{OUT} \times 0.075)$$

$$V_{IN(MAX)} = \frac{V_{OUT}}{f_{SW(MAX)} \times t_{ON(MIN)}}$$

where,

$V_{OUT}$  = Steady-state output voltage,

$I_{OUT}$  = Maximum load current

$f_{sw(MAX)}$  = Maximum switching frequency,

$t_{OFF(MAX)}$  = Worst-case minimum switch off-time (160ns),

$t_{ON(MIN)}$  = Worst-case minimum switch on-time (80ns).

[Table 1](#) provides operating input-voltage range and the optimum switching frequency for different selected output voltages.

### RESET Output

The device includes a  $\overline{RESET}$  comparator to monitor the output voltage. The open-drain  $\overline{RESET}$  output requires an external pullup resistor.  $\overline{RESET}$  goes high (high impedance) 1024 switching cycles after the regulator output increases above 95% of the designed nominal regulated voltage.  $\overline{RESET}$  goes low when the regulator output voltage drops to below 92% of the nominal regulated voltage.  $\overline{RESET}$  also goes low during thermal shutdown.

### Thermal Shutdown Protection

Thermal shutdown protection limits total power dissipation in the device. When the junction temperature of the device exceeds +165°C (typ), a thermal sensor shuts down the device, allowing the device to cool. The thermal sensor turns the device on again after the junction temperature cools by 10°C. Soft-start resets during thermal shutdown. Carefully evaluate the total power dissipation (see the [Power Dissipation](#) section) to avoid unwanted triggering of the thermal shutdown protection in normal operation.

### Overcurrent Protection

The MAXM17574 is provided with a robust overcurrent protection (OCP) scheme that protects the modules under overload and output short-circuit conditions. A cycle-by-cycle peak current limit turns off the high-side MOSFET whenever the high-side switch current exceeds an inter-

nal limit of 5.25A (typ). The module enters hiccup mode of operation, either if one occurrence of the runaway current limit 5.8A (typ), or if the FB node goes below 64.5% of its nominal regulation threshold after soft-start is complete. In hiccup mode, the module is protected by suspending switching for a hiccup timeout period of 32,768 clock cycles. Once the hiccup timeout period expires, soft-start is attempted again. Hiccup mode of operation ensures low power dissipation under output overload or short-circuit conditions. Note that when soft-start is attempted under overload condition, if feedback voltage does not exceed 64.5% of desired output voltage, the device switches at half the programmed switching frequency.

The MAXM17574 is designed to support a maximum load current of 3A. The inductor ripple current is calculated as follows:

$$\Delta I = \left[ \frac{V_{IN} - V_{OUT} - 0.27 \times I_{OUT}}{L \times f_{SW}} \right] \times \left[ \frac{V_{OUT} + 0.195 \times I_{OUT}}{V_{IN} - 0.075 \times I_{OUT}} \right]$$

where:

$V_{OUT}$  = Steady-state output voltage

$V_{IN}$  = Operating input voltage

$f_{SW}$  = Switching Frequency

$L$  = Power module output inductance (6.8μH ±20%)

$I_{OUT}$  = Required output (load) current

The following condition should be satisfied at the desired load current,  $I_{OUT}$ :

$$I_{OUT} + \frac{\Delta I}{2} < 4.4$$

## Applications Information

### Input-Capacitor Selection

The input capacitor serves to reduce the current peaks drawn from the input power supply and reduces switching noise to the IC. The input capacitor values in [Table 1](#) are the minimum recommended values for desired input and output voltages. Applying capacitor values larger than those indicated in [Table 1](#) are acceptable to improve the dynamic response. For other operating conditions, the total input capacitance must be greater than or equal to the value given by the following equation in order to keep the input-voltage ripple within specifications and minimize the high-frequency ripple current being fed back to the input source:



$$C_{IN} = \frac{I_{OUT(MAX)} \times D \times (1-D)}{\eta \times f_{SW} \times \Delta V_{IN}}$$

where,

D = The duty ratio of the controller ( $V_{OUT}/V_{IN}$ ),

$f_{SW}$  = The switching frequency,

$\Delta V_{IN}$  = The allowable input voltage ripple,

$I_{OUT(MAX)}$  = The maximum load current,

$\eta$  = The efficiency.

In applications, where the source is located distant from the device input, an electrolytic capacitor should be added in parallel to the ceramic capacitor to provide necessary damping for potential oscillations caused by the inductance of the longer input power path and input ceramic capacitor.

### Soft-Start Capacitor Selection

The device implements adjustable soft-start operation to reduce inrush current. A capacitor connected from the SS pin to SGND programs the soft-start time. The selected output capacitance ( $C_{SEL}$ ) and the output voltage ( $V_{OUT}$ ) determine the minimum required soft-start capacitor as follows:

$$C_{SS} \geq 28 \times 10^{-6} \times C_{SEL} \times V_{OUT}$$

The soft-start time ( $t_{SS}$ ) is related to the capacitor connected at SS ( $C_{SS}$ ) by the following equation:

$$t_{SS} = \frac{C_{SS}}{5.55 \times 10^{-6}}$$

For example, to program a 1ms soft-start time, a 5.6nF capacitor should be connected from the SS pin to SGND.

### Input Undervoltage-Lockout Level

The MAXM17574 contains an internal pullup resistor (3.3M $\Omega$ ) from EN/UVLO to  $V_{IN}$  to have a default startup voltage. The device offers an adjustable input undervoltage-lockout level to set the voltage at which the device is turned on by a single resistor connecting from EN/UVLO to SGND. Calculate the resistor using the following equation:

$$R_{ENU} = \frac{3.3 \times 1215}{V_{INU} - 1.215}$$

where  $R_{ENU}$  is in k $\Omega$  and  $V_{INU}$  is the voltage required to turn on the device. Ensure that  $V_{INU}$  is high enough to support the  $V_{OUT}$ . See [Table 1](#) to set the proper  $V_{INU}$

voltage greater than or equal to the minimum input voltage for each desired output voltage.

### Output Capacitor Selection

The X7R ceramic output capacitors are preferred due to their stability over temperature in industrial applications. The minimum recommended output capacitor values are listed in [Table 1](#) for desired output voltages to support a dynamic step load of 50% of the maximum output current and to contain the output-voltage deviation to 3% of the output voltage. For additional adjustable output voltages, the output capacitance value is derived from the following equation:

$$C_{OUT} = \frac{1}{2} \times \frac{I_{STEP} \times t_{RESPONSE}}{\Delta V_{OUT}}$$

$$t_{RESPONSE} \cong \left( \frac{0.33}{f_C} \right) + \left( \frac{1}{f_{SW}} \right)$$

where,

$I_{STEP}$  = Load current step,

$t_{RESPONSE}$  = Response time of the controller,

$\Delta V_{OUT}$  = Allowable output-voltage deviation,

$f_C$  = Target closed-loop crossover frequency,

$f_{SW}$  = Switching frequency.

Typically, select  $f_C$  to be 1/9th of  $f_{SW}$  if the switching frequency is less than or equal to 500kHz. If the switching frequency is more than 500kHz, select  $f_C$  to be 55kHz.

### Adjusting Output Voltage

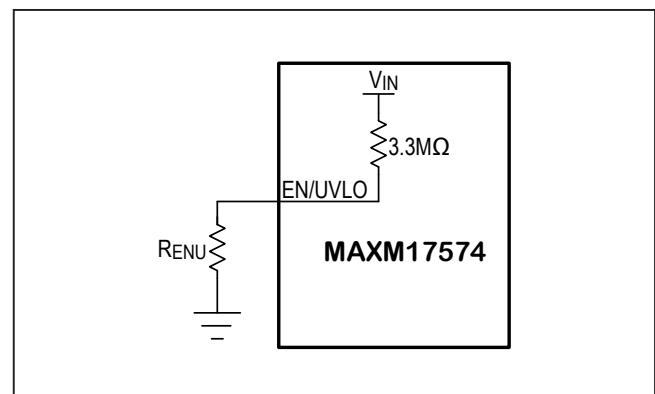

Figure 1. Setting the Input Undervoltage-Lockout Level

# MAXM17574

# 4.5V to 60V, 3A High-Efficiency, DC-DC Step-Down Power Module with Integrated Inductor

The MAXM17574 supports an adjustable output-voltage range of 0.9V to 15V by using a resistive feedback divider from OUT to FB. [Table 1](#) provides the feedback dividers for desired input and output voltages. Other adjustable output voltages programmed using the following procedure.

Calculate resistor  $R_U$  from the output to FB as follows:

$$R_U = \frac{216 \times 10^3}{f_C \times C_{OUT}}$$

where,

$R_U$  is in  $k\Omega$ ,

$f_C$  = Crossover frequency (kHz),

$C_{OUT}$  = Actual derated value of output capacitance ( $\mu F$ ).

Calculate the  $R_B$  resistor as

$$R_B = \frac{R_U \times 0.9}{V_{OUT} - 0.9}$$

where  $R_B$  and  $R_U$  are in  $k\Omega$ .

## Loop Compensation

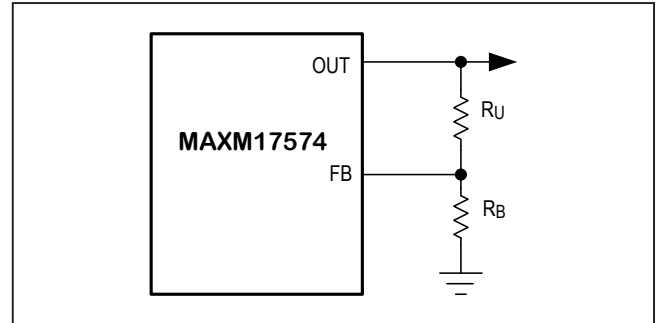

Figure 2. Setting the Output Voltage

## Table 1. Selection of Components

$V_{IN(MIN)}$ (V)	$V_{IN(MAX)}$ (V)	$V_{OUT}$ (V)	$C_{IN}$	$C_{OUT}$	$R_U$ (k $\Omega$ )	$R_B$ (k $\Omega$ )	$f_{SW}$ (kHz)	$R_{RT}$ (k $\Omega$ )	$C_{SS}$ (pF)
4.5	18	0.9	3 × 2.2 $\mu F$ 25V 1206	4 × 47 $\mu F$ 6.3V 1210	23.2	OPEN	500	OPEN	22000
4.5	18	1	3 × 2.2 $\mu F$ 25V 1206	4 × 47 $\mu F$ 6.3V 1210	23.2	200	500	OPEN	22000
4.5	15	1.2	3 × 2.2 $\mu F$ 25V 1206	3 × 47 $\mu F$ 6.3V 1210	33.2	100	450	44.2	22000
	30		3 × 2.2 $\mu F$ 50V 1206						22000
4.5	15	1.5	3 × 2.2 $\mu F$ 25V 1206	3 × 47 $\mu F$ 6.3V 1210	33.2	49.9	500	OPEN	22000
	30		3 × 2.2 $\mu F$ 50V 1206						22000
4.5	15	1.8	2 × 2.2 $\mu F$ 25V 1206	2 × 47 $\mu F$ 6.3V 1210	37.4	37.4	500	OPEN	22000
	40		2 × 2.2 $\mu F$ 50V 1206						22000
4.5	15	2.5	2 × 2.2 $\mu F$ 25V 1206	2 × 47 $\mu F$ 6.3V 1210	61.9	34.8	500	OPEN	22000
	40		2 × 2.2 $\mu F$ 50V 1206						22000
	54		2 × 2.2 $\mu F$ 100V 1210						22000
4.5	15	3.3	1 × 4.7 $\mu F$ 25V 1206	1 × 47 $\mu F$ 6.3V 1210	105	39.2	500	OPEN	22000
	40		1 × 4.7 $\mu F$ 50V 1206						22000
	60		1 × 4.7 $\mu F$ 80V 1210						22000
10	15	5	1 × 4.7 $\mu F$ 25V 1206	1 × 47 $\mu F$ 6.3V 1210	140	30.1	650	30.1	22000
	40		1 × 4.7 $\mu F$ 50V 1206						22000
	60		1 × 4.7 $\mu F$ 80V 1210						22000
18	40	8	1 × 2.2 $\mu F$ 50V 1206	1 × 22 $\mu F$ 10V 1210	200	24.9	1000	19.6	22000
	60		1 × 2.2 $\mu F$ 100V 1206						22000
24	40	12	1 × 1 $\mu F$ 50V 1206	2 × 10 $\mu F$ 25V 1210	255	20.5	1500	12.4	22000
	60		1 × 1 $\mu F$ 100V 1206						22000
28	40	15	1 × 1 $\mu F$ 50V 1206	2 × 10 $\mu F$ 25V 1210	300	19.1	2000	8.87	22000
	60		1 × 1 $\mu F$ 100V 1206						22000

The device is internally loop compensated. However, if the switching frequency is less than 500kHz, connect a 0402 capacitor ( $C_{CF}$ ) between the CF and FB pins. Use [Table 2](#) to select the value of capacitor ( $C_{CF}$ ).

### Power Dissipation

The power dissipation inside the module leads to increase in the junction temperature of the MAXM17574. The power loss inside the module at full load can be estimated as follows:

$$P_{LOSS} = P_{OUT} \times \left[ \frac{1}{\eta} - 1 \right]$$

Where  $\eta$  is the efficiency of the power module at the desired operating conditions. See the [Typical Operating Characteristics](#) for the power-conversion efficiency or measure the efficiency to determine the total power dissipation. The junction temperature ( $T_J$ ) of the module can be estimated at any given maximum ambient temperature ( $T_A$ ) from the following equation:

$$T_J = T_A + [\theta_{JA} \times P_{LOSS}]$$

For the MAXM17574 evaluation board, the thermal resistance from junction-to-ambient ( $\theta_{JA}$ ) is 22.6°C/W. Operating the module at junction temperatures greater than +125°C degrades operating lifetimes. An EE-SIM model is available for the MAXM17574 to simulate efficiency and power loss for the desired operating conditions.

### PCB Layout Guidelines

**Table 2. Loop Compensation**

SWITCHING FREQUENCY RANGE (KHZ)	$C_{CF}$ (PF)
200 to 300	2.2
300 to 400	1.2
400 to 500	0.75

Careful PCB layout is critical to achieve clean, stable operation and to minimize EMI. Use the following guidelines for good PCB layout. Refer to *MAXM17574 EVKIT data sheet* for a good sample layout.

- 1) Place  $R_{RT}$ ,  $C_{SS}$ ,  $R_U$ ,  $R_B$  components as close as possible to MAXM17574 respective pins.
- 2) Place the input capacitor as close as possible to the  $V_{IN}$  and PGND of the MAXM17574.
- 3) Place the output capacitor as close as possible to the OUT and PGND of the MAXM17574.
- 4) Connect both PGND and SGND to a large common copper pour or plane area (GND) on the top layer. Avoid breaking the ground connection between the external components and the MAXM17574.
- 5) Use multiple vias to connect internal GND planes to the top layer GND plane.
- 6) Do not keep any solder mask on EP1 and EP2 on the bottom layer. Keeping a solder mask on exposed pads decreases the heat-dissipating capability.

Typical Application Circuits

Typical Application Circuit-5V Output Application

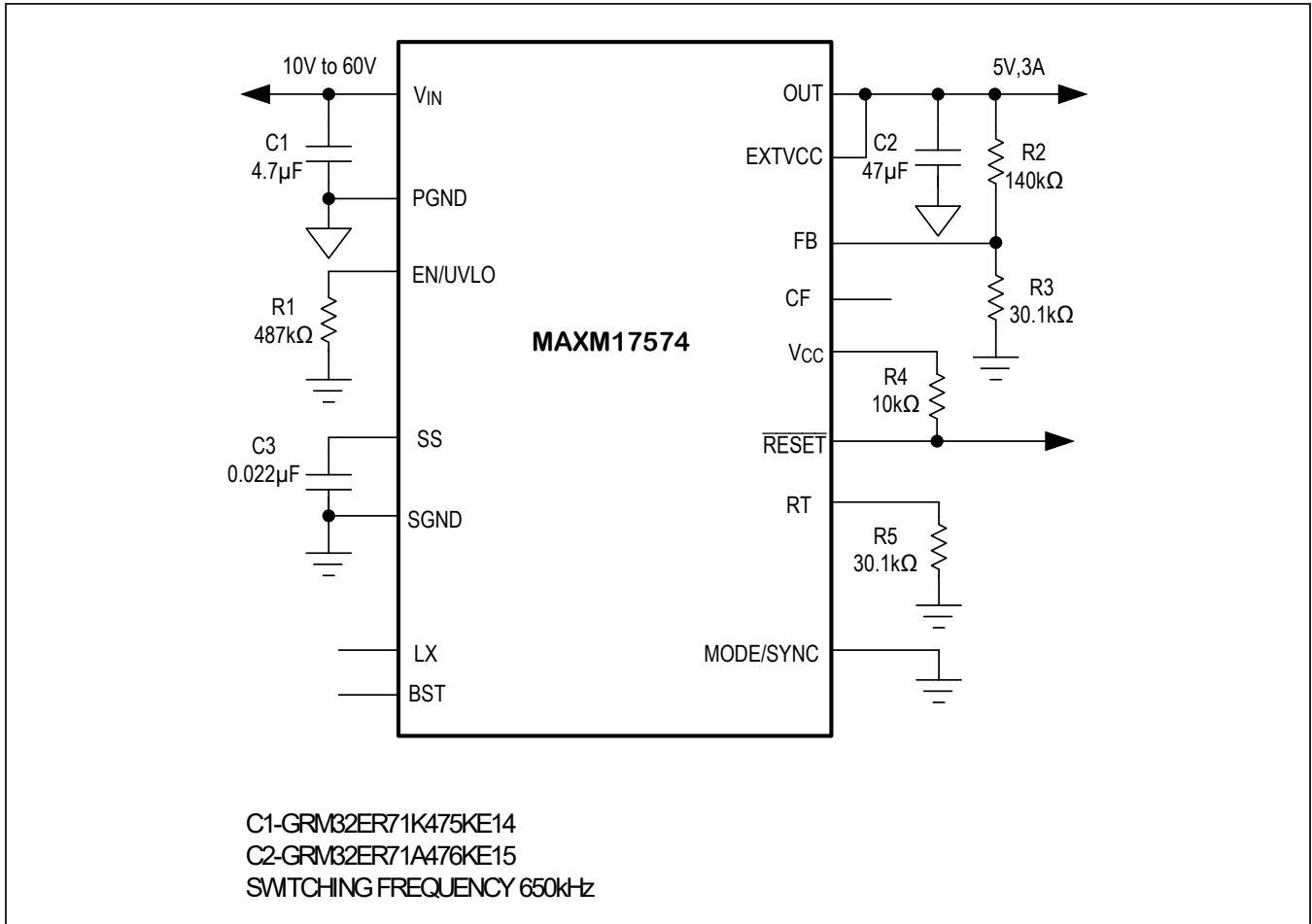

Typical Application Circuits (continued)

Typical Application Circuit-3.3V Output Application

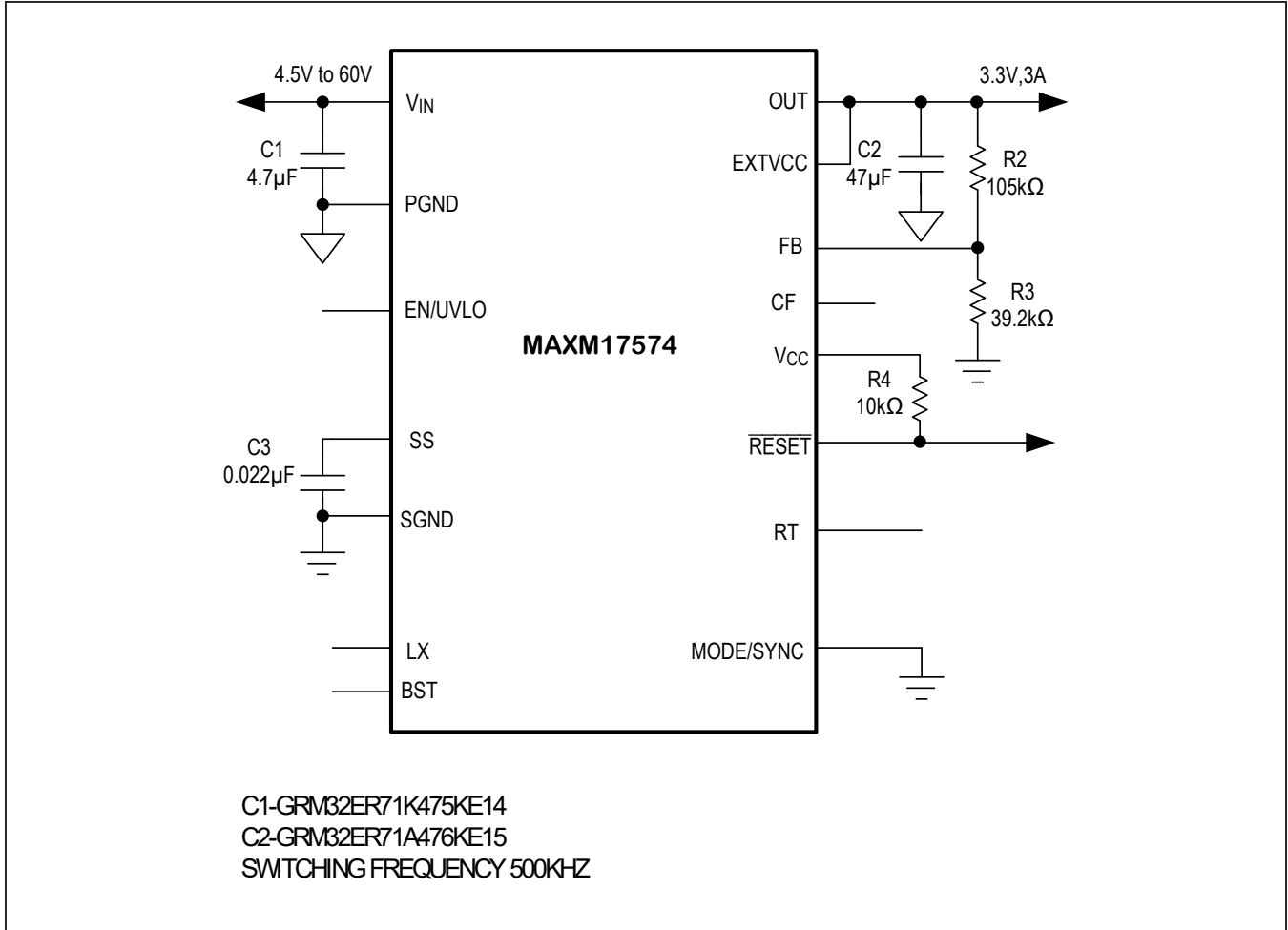

Ordering Information

PART NUMBER	TEMP RANGE	PIN-PACKAGE
MAXM17574ALC#T	-40°C to +125°C	33 SiP

# Denotes a RoHS-compliant device that may include lead(Pb) that is exempt under the RoHS requirements.

T = Tape and reel.

**Revision History**

REVISION NUMBER	REVISION DATE	DESCRIPTION	PAGES CHANGED
0	6/17	Initial release	—
1	9/17	Updated <i>Package Information</i> table, <i>Ordering Information</i> table, and Table 1. Updated <i>Linear Regulator (V<sub>CC</sub> and EXT<sub>VCC</sub>)</i> section.	1, 14, 17, 20
2	4/19	Updated the <i>Benefits and Features</i> and <i>Electrical Characteristics</i> sections; replaced the <i>Overcurrent Protection (OCP)/Hiccup Mode</i> and <i>Power Dissipation and Output-Current Derating</i> sections; added TOC54–TOC55	1, 4, 10, 15, 18

For pricing, delivery, and ordering information, please visit Maxim Integrated's online storefront at <https://www.maximintegrated.com/en/storefront/storefront.html>.

Maxim Integrated cannot assume responsibility for use of any circuitry other than circuitry entirely embodied in a Maxim Integrated product. No circuit patent licenses are implied. Maxim Integrated reserves the right to change the circuitry and specifications without notice at any time. The parametric values (min and max limits) shown in the *Electrical Characteristics* table are guaranteed. Other parametric values quoted in this data sheet are provided for guidance.